

Radio

HOW TO CHOOSE THE VIDEO TAPE THAT'S RIGHT FOR YOU!

MAY 1989

Electronics

TECHNOLOGY - VIDEO - STEREO - COMPUTERS - SERVICE

EXPERIMENTS WITH ISDN

Build our prototyping telephone and get in on the ground floor of ISDN, the Integrated Services Digital Network

BUILD A REMOTE-CONTROL EXTENDER

Expand the range of your remote control and watch your VCR in any room of your house!

CIRCUIT COOKBOOK

Practical op-amp circuits you can build today!

CAPACITORS

How to choose the right capacitor for the job

COMPUTER DIGEST

Build a digital-to-analog converter

VIDEO TAPES

Are "high grade" tapes worth the high price they command?



\$2.25 U.S.
\$2.75 CAN



A
GENSRACK
PUBLICATION

99 XXXXXXXXXX 5-DIGIT 60505
390736 DHM 0997G093 05
JAN 90
MR ROBERT DAHM RE
997 GRAND AV
AURORA, IL 60505

FLUKE



PHILIPS

How to beat the high cost of cheap meters.



You get what you pay for.

So get the Fluke 70 Series.

You'll get more meter for your money, whether you choose the affordable 73, the feature-packed 75 or the deluxe 77.

All of them will give you years of performance, long after cheaper meters have pegged their fishhook needles for the last time.

That's because they're built to last, inside and out. So they're tough to break. They don't blow fuses all the time. You don't even have to replace batteries as often.

And they're backed by a 3-year warranty. Not the usual 1-year.

Of course, you may only care that the world-champion 70 Series combines digital and analog displays with more automatic features, greater accuracy and easier operation than any other meters in their class.

You may not care that they have a lower overall cost of ownership than all the other "bargain" meters out there.

But just in case, now you know.

For a free brochure or your nearest distributor, call toll-free

1-800-44-FLUKE, ext. 33.

FROM THE WORLD LEADER
IN DIGITAL MULTIMETERS



FLUKE 73

\$79*
Analog/digital display
Volts, ohms, 10A, diode test
Autorange
0.7% basic dc accuracy
2000+ hour battery life
3-year warranty



FLUKE 75

\$119*
Analog/digital display
Volts, ohms, 10A, mA, diode test
Audible continuity
Autorange/range hold
0.5% basic dc accuracy
2000+ hour battery life
3-year warranty



FLUKE 77

\$159*
Analog/digital display
Volts, ohms, 10A, mA diode test
Audible continuity
Touch Hold™ function
Autorange/range hold
0.3% basic dc accuracy
2000+ hour battery life
3-year warranty
Multipurpose holster

* Suggested U.S. list price, effective October 1, 1988

FLUKE

BUILD THIS

35 ISDN PROTOTYPING TELEPHONE

Get in on the ground floor of ISDN with our development platform.
Doug Tousignant

41 I-R EXTENDER

Control your VCR from any room of your house—and watch its output on any TV!
Robert A. Heil

77 DIGITAL-TO-ANALOG CONVERTER

Real-world outputs from your computer.
David Weber

TECHNOLOGY

45 VIDEOTAPES: CHOOSING THE ONE THAT'S RIGHT FOR YOU

Are high-grade videotapes worth the high price they command?
Len Feldman

CIRCUITS

49 CAPACITORS

How to choose the right capacitor for the job.
Josef Bernard

54 WORKING WITH OP AMPS

Designing circuits with the LM741 op amp.
Ray Marston

DEPARTMENTS

6 VIDEO NEWS

What's new in this fast-changing field.
David Lachenbruch

17 EQUIPMENT REPORTS

Mark V SM 333 Surround Sound Processor.

17 EQUIPMENT REPORTS

Lynx 470 Disk Drive Tester.

61 HARDWARE HACKER

Phase-plane plots.
Don Lancaster

70 AUDIO UPDATE

The dynamic loudspeaker.
Larry Klein

72 DRAWING BOARD

Let's start programming!
Robert Grossblatt

74 ANTIQUE RADIO

How television got its start.
Richard D. Fitch

77 EDITOR'S WORKBENCH

Software reviews and more.
Jeff Holtzman

COMPUTER DIGEST



EDITOR'S WORKBENCH

Covered against the odds, we've got a lot of interesting projects for you. The 100-watt Class D VCR was a challenge to build, but we've got the theory and practice of digital-to-analog converters. The 100-watt Class D VCR was a challenge to build, but we've got the theory and practice of digital-to-analog converters. The 100-watt Class D VCR was a challenge to build, but we've got the theory and practice of digital-to-analog converters.

PAGE 77

BUILD THIS REMOTE CONTROL



EXTENDER

Control your VCR and watch movie tapes from any room in your home with our VCR extender.

Control your VCR and watch movie tapes from any room in your home with our VCR extender. Control your VCR and watch movie tapes from any room in your home with our VCR extender. Control your VCR and watch movie tapes from any room in your home with our VCR extender.

PAGE 41

AND MORE

- 104 Advertising and Sales Offices
- 104 Advertising Index
- 12 Ask R-E
- 105 Free Information Card
- 15 Letters
- 87 Market Center
- 22 New Products
- 59 PC Service
- 4 What's News

ON THE COVER



The telephone of tomorrow is here today. Our ISDN prototyping telephone will allow you to learn about the features that ISDN can provide. And it will allow you to simulate and experiment with ISDN-like features even if you don't have ISDN service available yet.

Just what will ISDN let you do? You'll be able to identify who's calling before you pick up, screening out junk calls. You can have calls forwarded to you wherever you are. Instead of having a stack of messages on your desk, your computer can store them for you. To fully understand what ISDN is all about, and to find out how you can get a head start on using ISDN, turn to page 35.

COMING NEXT MONTH

**THE JUNE ISSUE
IS ON SALE
MAY 4.**

SURVEILLANCE CHECKER

An easy-to-build RF detector warns you if more serious investigation is called for.

RADALERT FOLLOW-UP

Another look at our radiation monitor, including a computer interface and user networks.

AMATEUR TV TRANSMITTER

For licensed hams only ... all the details needed to build an ATV or Amateur Television Transmitter.

ISDN EXPERIMENTS

Put the Millcom ISDN prototyping telephone to work.

As a service to readers, RADIO-ELECTRONICS publishes available plans or information relating to newsworthy products, techniques and scientific and technological developments. Because of possible variances in the quality and condition of materials and workmanship used by readers, RADIO-ELECTRONICS disclaims any responsibility for the safe and proper functioning of reader-built projects based upon or from plans or information published in this magazine.

Since some of the equipment and circuitry described in RADIO-ELECTRONICS may relate to or be covered by U.S. patents, RADIO-ELECTRONICS disclaims any liability for the infringement of such patents by the making, using, or selling of any such equipment or circuitry, and suggests that anyone interested in such projects consult a patent attorney.

RADIO-ELECTRONICS, (ISSN 0033-7862) May 1989. Published monthly by Gernsback Publications, Inc., 500-B Bi-County Boulevard, Farmingdale, NY 11735 Second-Class Postage paid at Farmingdale, NY and additional mailing offices. Second-Class mail registration No. 9242 authorized at Toronto, Canada. One-year subscription rate U.S.A. and possessions \$17.97, Canada \$23.97, all other countries \$26.97. All subscription orders payable in U.S.A. funds only, via international postal money order or check drawn on a U.S.A. bank. Single copies \$2.25. © 1989 by Gernsback Publications, Inc. All rights reserved. Printed in U.S.A.

POSTMASTER: Please send address changes to RADIO-ELECTRONICS, Subscription Dept., Box 55115, Boulder, CO 80321-5115.

A stamped self-addressed envelope must accompany all submitted manuscripts and/or artwork or photographs if their return is desired should they be rejected. We disclaim any responsibility for the loss or damage of manuscripts and/or artwork or photographs while in our possession or otherwise.

Radio Electronics

Hugo Gernsback (1884-1967) founder

M. Harvey Gernsback,
editor-in-chief, emeritus

Larry Steckler, EHF, CET,
editor-in-chief and publisher

EDITORIAL DEPARTMENT

Art Kleiman, editorial director

Brian C. Fenton, editor

Carl Laron, WB2SLR,
editorial associate

Marc Spiwak, associate editor

Jonathan A. Gordon,
assistant technical editor

Teri Scaduto, assistant editor

Jeffrey K. Holtzman,
computer editor

Robert A. Young, assistant editor

Byron G. Wels, editorial associate

Jack Darr, CET, service editor

Robert Grossblatt, circuits editor

Larry Klein, audio editor

David Lachenbruch,
contributing editor

Don Lancaster,
contributing editor

Richard D. Fitch,
contributing editor

Kathy Campbell, editorial assistant

Andre Duzant, technical illustrator

Injae Lee, assistant illustrator

PRODUCTION DEPARTMENT

Ruby M. Yee, production director

Robert A. W. Lowndes,
editorial production

Karen Tucker, advertising production

Marcella Amoroso, production traffic

CIRCULATION DEPARTMENT

Jacqueline P. Cheeseboro,
circulation director

Wendy Alanko,
circulation analyst

Theresa Lombardo,
circulation assistant

Typography by Mates Graphics

Cover photo by

Diversified Photo Services

Radio-Electronics is indexed in *Applied Science & Technology Index* and *Readers Guide to Periodical Literature*.

Microfilm & microfiche editions are available. Contact circulation department for details.

Advertising Sales Offices listed on page 104.



New Smart Scope makes troubleshooting trouble-free.

When you're looking for trouble, the new 100 MHz Tek 2247A will help you find it—fast.

With its integrated counter/timer, Auto Setup, unique Smart-Cursors™ and voltmeter, the 2247A makes short work of the measurements you need most.

The built-in counter/timer/voltmeter automatically calculates and displays more than 11 different voltage and time measurements.



Time-saving automation and ease of use are built into every measurement routine.

The 2247A gives you one-button setup, storage and recall of up to 20 setups, time and voltage cursors, plus on-screen readouts. It also measures rise/fall time and propagation delay automatically, with counter accuracy to 0.001%.

Best of all is the price: only \$2795! This is the most extensive set of capabilities ever

assembled in a low-cost scope. And it's backed by Tek's standard 3-year warranty on parts and labor—including the CRT.

| | |
|------------------------------------|-----------------------|
| Bandwidth | 100 MHz |
| No. of channels | 4 |
| Vertical/Horizontal Accuracy | 2% |
| Integrated Counter/Timer/Voltmeter | Yes |
| TV Line and TV Field Triggering | Yes |
| Auto Setup | Yes |
| Store/Recall | 20 front-panel setups |
| SmartCursors™ | Yes |
| Warranty | 3 years, incl. CRT |

LISTED

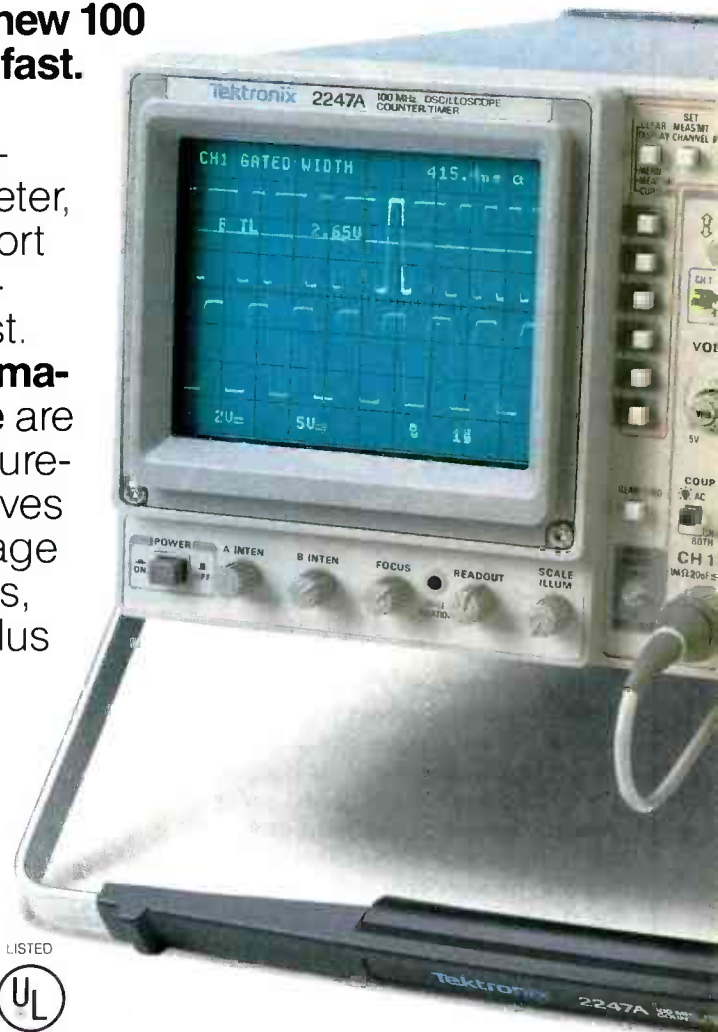

Getting one is easy, too.

For rapid ordering or a free videotape demonstration, call Tek today.

1-800-426-2200



Tektronix®
COMMITTED TO EXCELLENCE

WHAT'S NEWS

Space settlements built from space materials

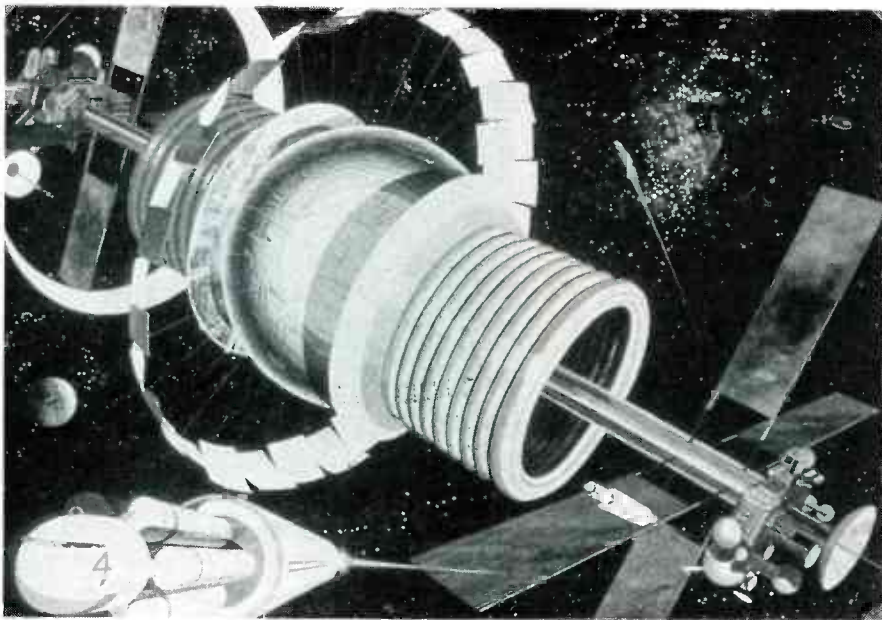

NASA'S RENDITION OF a 10,000-person space-habitat design.

Last November, President Reagan signed into effect legislation that might help pave the way toward the development of human space colonies within Earth's solar system. The Space Settlement Act, now part of the NASA Authorization Bill, provides for the agency to file regular reports on the technology and economics of space settlements, and the social, psychological, legal, political, and international implications of human settlement of the extra-Earth solar system.

The Space Studies Institute of Princeton, NJ, a long-time advocate of industrial development in space, believes that such settlements can be built in free space from materials that are already in space. Those materials include man-made space debris and lunar resources. Three studies conducted by NASA in the mid-70's suggested that it is feasible to build space colonies from lunar materials. That would make it a lot less expensive to build such colonies.

Volt to change its value in 1990

An international conference of representatives of the world's weights-and-measures community met recently in Sèvres, France, to adopt new "conventional values" for the *Josephson constant* and the *von Klitzing constant*. Those are two fundamental physical values used to determine the value of the volt, using the AC Josephson effect, and the value of

the ohm, using the quantum Hall effect.

That means that all industrial nations will have—for the first time—a common practical basis for measuring voltage and resistance. The new standards will take effect January 1, 1990.

The changes will not be highly significant to the practical technician; they will change the value of the volt by only about 9.3 parts per

million (ppm). They will be important in the international electronics world. At present, there is a slight difference (about 1.2 ppm) between American and most European standards. With the precision required in some technologies, that is enough to make an importance difference to U.S. firms wishing to export high-precision equipment to Europe.

Satellite subscribers challenge cable claims

Advertisements abound—in programming guides and newspaper entertainment pages and on TV—that claim to offer exclusive viewing of choice shows to cable subscribers. In reality, that same programming is almost always available to satellite-dish owners (usually for a subscription fee) as well. Those misleading ads are being challenged by the Empire State Dealers Association in conjunction with K-SAT, the satellite-dish owners' consumer advocacy/lobbyist group.

The New York State dealers' organization and Gilroy, CA-based K-SAT have served C-SPAN (the Cable Satellite Public Affairs Network) with a formal "Cease and Desist" notice, with the intention to sue. They consider C-SPAN's advertisements, which include the statements "Exclusively on Cable" and "Only on Cable," to be part of a deliberate "nationwide push by Cable MSO's (multiple systems operators) and their programmers to misinform the public as to the alternatives to cable." Chuck Dawson of K-SAT expects that the challenge will result in an antitrust lawsuit.

K-SAT is also sponsoring "The Cable Subscriber Bill Of Rights;" encouraging dish owners and cable subscribers to withhold payment of their April cable bills for 30 days; and deluging legislators with visits, letters, and phone calls.

R-E

Cursors To Cure Measurement Curses.

Beckman Industrial
Introduces The Series 9000.
Speed, Accuracy, Performance
And Value.

Presenting a new family of quality oscilloscopes with professional features. Choose from six models with frequency ranges of 20, 40 and 60MHz.



Model 9106,
60MHz,
3 Channel,
Dual Sweep
(A & B).

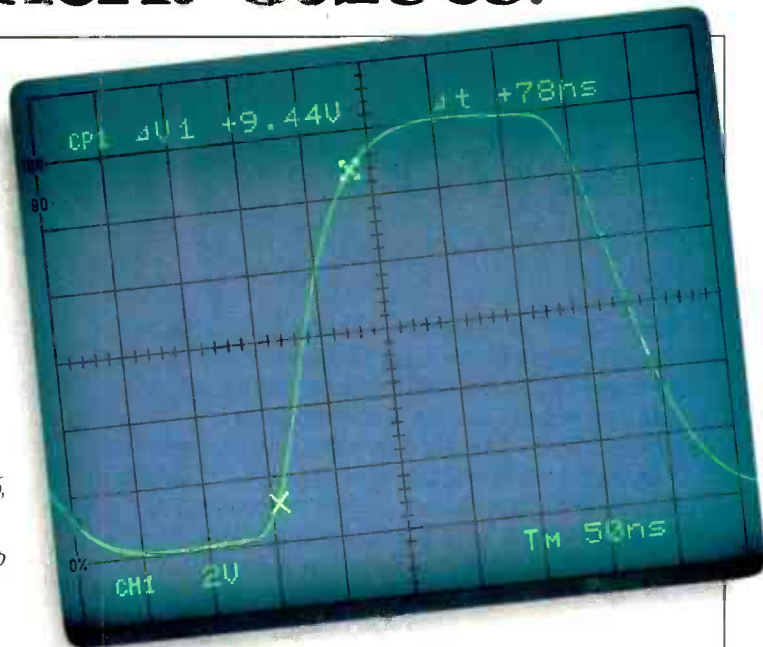

Independent cursors and on-screen readouts make waveform measurements fast and accurate.

Five of six models feature two independently-adjustable time bases. Built-in intensity modulation allows you to select a small section of a main waveform for closer examination. This feature is ideal for measuring pulse rise times or checking sync pulse amplitudes in composite video signals.

Cursors And On-Screen Readouts.

Two sets of independent cursors are featured on Models 9202 and 9204. Simply position the cursors on the waveform and you instantly have accurate on-screen numeric readouts of amplitude, time, frequency, duty cycle and phase shift. A separate frequency counter is unnecessary. Interpolation is eliminated. You save time. Improve accuracy.

Solid Design.

The Series 9000 features a low-profile cabinet, logically grouped controls, camera-mount CRT bezel and graticule illumination for waveform photography. Most models feature a three year warranty.

The Series 9000 Oscilloscope. Only from Beckman Industrial. Finally, the affordable cure for measurement curses.



Model 9204, 40MHz,
On-Screen CRT Readout.

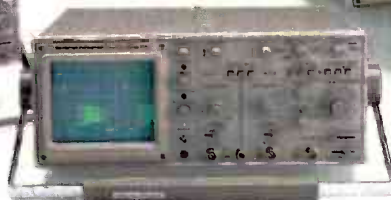

Model 9104, 40MHz,
2 Channel, Dual Sweep (A & B).



Model 9022, 20MHz,
2 Channel.

| FEATURES | 9106 | 9104 | 9204 | 9202 | 9102 | 9022 |
|------------------------------|---------|--------|---------|--------|--------|--------|
| Max Frequency | 60MHz | 40MHz | 40MHz | 20MHz | 20MHz | 20MHz |
| Input Channels | 3 | 2 | 2 | 2 | 2 | 2 |
| Dual Sweep (A & B) | • | • | • | • | • | |
| CRT Readout | | | • | • | | |
| Cursor Readout | | | • | • | | |
| Switchable X1/REF/X10 Probes | 2 | 2 | 2 | 2 | 2 | 2 |
| Warranty | 3 year | 3 year | 3 year | 3 year | 3 year | 1 year |
| Price | \$1,290 | \$950 | \$1,095 | \$865 | \$700 | \$550 |

Beckman Industrial™

Beckman Industrial Corporation
Instrumentation Products Division
A Subsidiary of Emerson Electric Company
3883 Ruffin Road, San Diego, CA 92123-1898
(619) 495-3200 • FAX (619) 268-0172 • TLX 249031

VIDEO NEWS



DAVID LACHENBRUCH,
CONTRIBUTING EDITOR

• **More LCD projectors.** Eastman Kodak is the brand name on the first projection-TV system to use three LCD's for light valves, using no cathode ray tubes (**Radio-Electronics**, November 1988). The Kodak unit, which sells to the industrial and commercial market for \$3,500, is made by Seiko in Japan. It has resolution of 70,400 pixels, and uses a 300-watt projection bulb as a light source. It's capable of projecting a picture up to 12 feet wide. The unit is focusable, uses only single-lens assembly, and is small enough to fit under an airplane seat. It's designed to project both video and computer graphics, and has digital and analog RGB inputs as well as composite video.

Next fall, Kodak's LCD projector will be joined on the market by a consumer model that is built by Sharp. As we last saw this unit, it had a picture of 92,160 pixels—more detailed than the Seiko/Kodak model, but still a relatively coarse image. At the Japan Electronics Show, Toshiba and Sanyo also showed developmental LCD TV projectors, but supplied no information on availability dates.

An American-developed three-LCD projector is now being demonstrated to potential manufacturers by a New York company called Projectavision.

Eugene Dolgoff, Projectavision's president and the inventor of the unit, has filed a suit against Eastman Kodak and Seiko Epson, claiming that they violated a non-disclosure agreement and are using his projector's principles. Kodak and Seiko deny the charges. Dolgoff hopes to interest American companies in manufacturing his projector.

A completely different kind of projector will be marketed here by Panasonic as an accessory to its combination portable VCR and LCD TV. The projector uses a mirror-and-lens assembly to enlarge the 3-inch LCD picture to about 25-inch size on an external screen in a darkened room.

Meanwhile, direct-view LCD panels are getting larger. At the Japan show, Epson showed (but didn't demonstrate) prototypes of three large sizes—5.3-inch with 150,892-pixel resolution, 7-inch with 460,800 pixels, and 10-inch with

768,000 pixels. Sharp demonstrated a working model of a 14-inch panel with 308,160-pixel resolution.

• **Working together on HDTV.** Seventeen companies—only one of them currently involved in television-receiver manufacturing—have agreed to study the possibility of setting up a consortium, presumably with government support, to conduct R&D on high-definition TV receivers. Formed under the aegis of the Silicon Valley-based American Electronics Association, the group includes some of the largest electronics firms in the U.S., such as AT&T, IBM, Hewlett-Packard, Motorola, ITT, Apple, and Zenith. In announcing the project, the firms stressed that they haven't yet decided whether such a plan is practical. The group's stated purpose is to decide whether to set up at least one for-profit partnership "to capture or assist in the capture of a majority of the hardware markets associated with an anticipated U.S. HDTV business." Except for Zenith, none of the firms involved have made any effort to enter the TV-hardware business on their own; Motorola and ITT have previously been in the TV-receiver business and sold out to foreign interests.

The study comes at a time when Congress and the Commerce and Defense Departments have expressed strong interest in domestic HDTV manufacture as a means of reviving American technological leadership and increasing consumption of American semiconductors. The Department of Defense is prepared to invest up to about \$30 million to subsidize R&D leading to an efficient, low-cost, high-definition video monitor or receiver. The Defense Advanced Research Projects Agency (DARPA) says that it needs the display for applications in command, control, battle management, training, simulation, and other areas, and that using a system that also has mass-market television uses would save money for the government. Zenith has submitted a proposal for a Pentagon grant to develop its Flat Tension Mask (FTM) computer-display tube into a display for high-definition video systems. **R-E**

HITACHI SCOPES AT DISCOUNT PRICES



V-212
\$399

List \$560
Save \$161

20MHz Dual Trace Oscilloscope

All Hitachi scopes include probes, schematics and Hitachi's 3 year guaranty on parts and labor. Many accessories available for all scopes.



V-425
List \$995 **\$835**

- DC to 40MHz
- Dual Channel
- CRT Readout
- Cursor Meas
- DC Offset
- Alt Magnifier
- Compact Size



V-1060
List \$1595 **\$1,285**

- DC to 100MHz
- Dual Channel
- Delayed Sweep
- CRT Readout
- Sweep Time
- Autoranging
- Trigger Lock
- 2mV Sensitivity

| | LIST | PRICE | SAVE |
|----------------|---------|---------|-------|
| V-223 20MHz | \$770 | \$695 | \$75 |
| V-422 40MHz | \$875 | \$695 | \$180 |
| V-423 40MHz | \$955 | \$795 | \$160 |
| V-660 60MHz | \$1,195 | \$990 | \$205 |
| V-1065 100MHz | \$1,895 | \$1,670 | \$225 |
| V-1100A 100MHz | \$2,295 | \$1,995 | \$300 |
| V-1150 150MHz | \$3,100 | \$2,565 | \$535 |

ELENCO PRODUCTS AT DISCOUNT PRICES

20MHz Dual Trace Oscilloscope



\$359
MO-1251

- 6" CRT
- Built in component tester
- TV Sync
- X-Y Operation

FREE DMM
with purchase of
MO-1251/1252 Scope

SCOPE PROBES
P-1 65MHz, 1x, 10x **\$19.95**
P-2 100MHz, 1x, 10x **\$23.95**
Fits all scopes with
BNC connector

35MHz Dual Trace Good to 50MHz

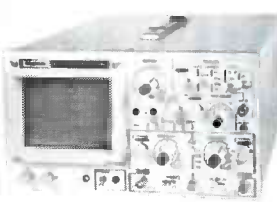

\$495
MO-1252

- High luminance 6" CRT
- 1mV Sensitivity
- 6KV Acceleration Voltage
- 10ns Rise Time
- X-Y Operation • Z Axis
- Delayed Triggering Sweep

Top quality scopes at a very reasonable price. Contains all desired features. Two 1x, 10x probes, diagrams and manual. Two year guarantee.

Autoranging DMM



M-5000
\$45

- 9 Functions
- Memory and Data hold
- 1/2% basic acc
- 3 1/2 digit LCD

True RMS 4 1/2 Digit Multimeter



\$135
M-7000

- .05% DC Accuracy
- .1% Resistance with Freq. Counter and deluxe case

Multimeter with Capacitance and Transistor Tester



\$55
CM-1500

- Reads Volts, Ohms, Current, Capacitors, Transistors and Diodes with case

Digital Capacitance Meter

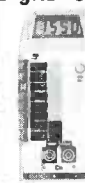

CM-1550
\$58.95

- 9 Ranges
- .1pf-20,000ufd
- 5% basic accy
- Zero control with case

Digital LCR Meter



LC-1801
\$125

- Measures Coils 1uH-200H
- Caps .1pf-200uf
- Res .01-20M

AC Clamp-On Current Adapter



ST-265
\$22

- 0-1000A AC
- Works with most DMM

Bench DMMS



M-3500
3 1/2 digit **\$125**

M-4500
4 1/2 digit **\$175**

SOLDERING STATION TEMPERATURE CONTROLLED



SL-30
\$135

- Digital display
- Temp range: 300F-900F
- Grounded tip
- Overheat prot

Solderless Breadboards



- 9430 1,100 pins **\$15**
- 9434 1,100 pins **\$15**
- 2,170 pins **\$25**
- 9436 2,170 pins **\$25**
- 2,860 pins **\$35**
- All have color coded posts
- 9436 SHOWN

Low Cost Multimeter

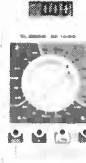

M-1600
\$25

- 3 1/2 digit LCD
- 1% DC Accy
- 10A Scale
- Auto zero /polarity

Wide Band Signal Generators



SG-9000 **\$129**
RF Freq 100K-450MHz
AM Modulation of 1KHz
Variable RF output

SG-9500 with Digital Display and 150MHz built-in Freq Ctr \$249

3 1/2 Digit Probe Type DMM



M-1900
\$39

- Convenient one hand operation with batteries and case
- Measures DCV, ACV, Ohms
- Audible continuity check, Data hold

Function Generator Blox



#9600
\$28.95

- Provides sine, tri, squ wave
- From 1Hz to 1MHz
- AM or FM capability

Decade Blox



9610 or 9620
\$18.95

- #9610 Resistor Blox 47 ohm to 1M & 100K pot
- #9620 Capacitor Blox 47pf to 10MFD

Digital Triple Power Supply



XP-765
\$249

- 0-20V at 1A
- 0-20V at 1A
- 5V at 5A

Fully Regulated, Short circuit protected with 2 Limit Cont., 3 Separate supplies
XP-660 with Analog Meters \$175

Quad Power Supply



XP-580
\$59.95

- Fully regulated and short circuit protected

XP-575 without meters \$39.95

10MHz XT 100% IBM® Compatible

5 Year Warranty



\$595
MODEL PC-1000

- 5/10MHz Motherboard
 - 8 Expansion Slots
 - Math Compressor Slots
 - 360K Floppy Drive
 - AT Style Keyboard
 - 150W Power Supply
 - 256K RAM
 - Expandable to 640K
 - Monochrome Monitor
 - Monographic Video Card
 - Parallel Printer Port
- FREE spreadsheet and word processor**
3.XXMS DOS and GW Basic add \$75

Four-Function Frequency Counters



F-1000 1.2GH
\$259

F-100 120MH
\$179

- Frequency, Period, Totalize, Self Check with High Stabilized Crystal Oven Oscillator, 8 digit LED display

GF-8016 Function Generator with Freq. Counter



\$239

- Sine, Square, Triangle Pulse, Ramp, .2 to 2MHz
- Freq Counter .1 - 10MHz

GF-8015 without Freq. Meter \$179

WE WILL NOT BE UNDERSOLD!

UPS Shipping: US 5%

(\$10 Max) IL Res., 7% Tax



C & S SALES INC.
1245 Rosewood, Deerfield, IL 60015
(800) 292-7711 (312) 541-0710

15 Day Money Back Guarantee
2 Year Warranty

WRITE FOR FREE CATALOG

Learn to troubleshoot and service today's computer systems as you build a fully XT-compatible micro, complete with 512K RAM and powerful 20 meg hard drive

Train the NRI Way— and Earn Good Money Servicing Any Brand of Computer

Jobs for computer service technicians will almost double in the next 10 years according to Department of Labor statistics, making computer service one of the top 10 growth fields in the nation.

Now you can cash in on this exciting opportunity— either as a full-time industry technician or in a computer service business of your own—once you've mastered electronics and computers the NRI way.

NRI's practical combination of "reason-why" theory and hands-on building skills starts you with the fundamentals of electronics, then guides you through more sophisticated circuitry all the way up to the latest advances in computer technology. You even learn to program in BASIC and machine language, the essential language for troubleshooting and repair.

Train With a Powerful XT-Compatible — Now With 20 Meg Hard Drive!

To give you hands-on training with the absolute in state-of-the-art computer



You build this powerful Packard Bell VX88 computer, all the while gaining a true mastery of computer electronics. Best of all, it's yours to keep for all your professional and personal computing needs.



technology, NRI includes the powerful new Packard Bell VX88 computer as the centerpiece of your training. As you assemble this fully IBM XT-compatible micro from the keyboard up, you actually see for yourself how every section of your computer works.

You assemble and test your computer's "intelligent" keyboard, install the power supply and 5¼" disk drive, then interface the high-resolution monitor. But that's not all.

Your hands-on training continues as you install a powerful 20 megabyte hard disk drive—today's most-wanted computer peripheral—now included in your course to dramatically increase

Your NRI computer training includes all this:

- NRI's unique Discovery Lab® for circuit design and diagnosis
- NRI's hand-held digital multimeter featuring "talk-you-through" instructions on audio cassette
- A digital logic probe that lets you visually examine computer circuits
- The new Packard Bell VX88 computer with "intelligent" keyboard, 360K double-sided, double-density disk drive, 512K RAM, 16K ROM
- 20 megabyte hard disk drive
- Bundled software including MS-DOS, GW-BASIC, word processing, spreadsheet, and database programs
- Packard Bell reference manuals with programming guidelines and schematics.



NEW!

Includes 20 meg Hard Drive

throughout your training, you've got the full support of your personal NRI instructor and the NRI technical staff, always ready to answer your questions and help you whenever you need it.

FREE 100-Page Catalog Tells More

Send today for NRI's big, 100-page, full-color catalog that describes every aspect of NRI's innovative computer training, as well as hands-on training in robotics, video/audio servicing, electronic music technology, security electronics, data communications, and other growing high-tech career fields. If the coupon is missing, write to: NRI School of Electronics, McGraw-Hill Continuing Education Center, 4401 Connecticut Avenue, NW, Washington, DC 20008.



McGraw-Hill Continuing Education Center
4401 Connecticut Avenue, NW
Washington, DC 20008

IBM is a registered trademark of International Business Machines Corporation

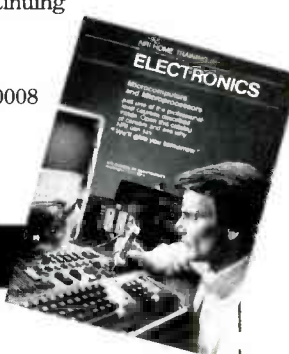

the data storage capacity of your computer while giving you lightning-quick data access. Plus you work with exclusive word processing, database, and spreadsheet software, yours to use for your own professional and personal applications.

As you build your computer, performing key demonstrations and experiments at each stage of assembly, you get the confidence-building, real-world experience you need to work with, troubleshoot, and service today's most widely used computer systems.

service. You learn at your own convenience in your own home.

No classroom pressures, no night school, no need to quit your present job until you're ready to make your move. And all

Experience Needed, NRI Builds It In

This is the kind of practical, hands-on experience that makes you uniquely prepared to take advantage of today's opportunities in computer

SEND TODAY FOR FREE CATALOG!



McGraw-Hill Continuing Education Center
4401 Connecticut Avenue, NW, Washington, DC 20008

For Career courses approved under GI Bill
 check for details.



- CHECK ONE FREE CATALOG ONLY**
- Computer Electronics
 - TV/Video/Audio Servicing
 - Robotics
 - Electronic Music Technology
 - Security Electronics
 - Digital Electronics Servicing
 - Electronic Design Technology
 - Industrial Electronics
 - Communications Electronics
 - Basic Electronics
 - Bookkeeping and Accounting
 - Building Construction
 - Automotive Servicing
 - Air Conditioning, Heating & Refrigeration
 - Small Engine Repair
 - Electrician
 - Locksmithing & Electronic Security
 - Travel Careers
 - Computer Programming
 - Paralegal

Name (Please print) _____ Age _____
 Street _____
 City/State/Zip _____ We'll give you tomorrow. Accredited by the National Home Study Council 3-059

MAY 1989

ASK R-E

WRITE TO:

ASK R-E
Radio-Electronics
500-B Bi-County Blvd.
Farmingdale, NY 11735

FLASHING LED'S

I've been trying to build a sequential LED flasher using 4017's, but I haven't had much luck. Could you show me how to cascade two more of those devices? Any help would be appreciated.—K. Gordon Knoxville, TN.

The CMOS 4017 is a one-of-ten decoder that's a perfect choice any time you want to build something using sequencing logic. If you only need ten outputs, all you have to do to use the IC is pay attention to the pins, plug in the peripherals, and power up the part. Things get a bit more complicated when you want to increase the count beyond ten because the 4017 wasn't designed with that application in mind. That doesn't mean that you *can't* do it. It just means you have to think about *how* to do it.

There are two ways to cascade the 4017. You can use them as decade counters (the job they were intended for), or you can have them do sequential counting (a job they weren't intended for). For decade counting, all you have to do is use the CARRY output (pin 12) of one 4017 as the clock input of the following 4017—that's what CARRY is designed for. A simple implementation of that is shown in Fig. 1, and the same idea can be used to extend the count as far as you need. The first 4017 counts the units, the second the tens, the third the hundreds...but I think you get the idea.

Sequential counting with the 4017 is completely different and it's complicated by the fact that there's no way to turn off all the outputs. The basic idea is to drive all the

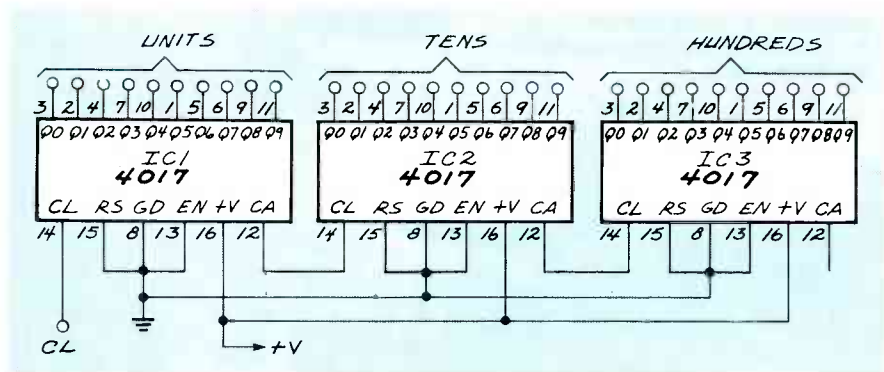

FIG. 1

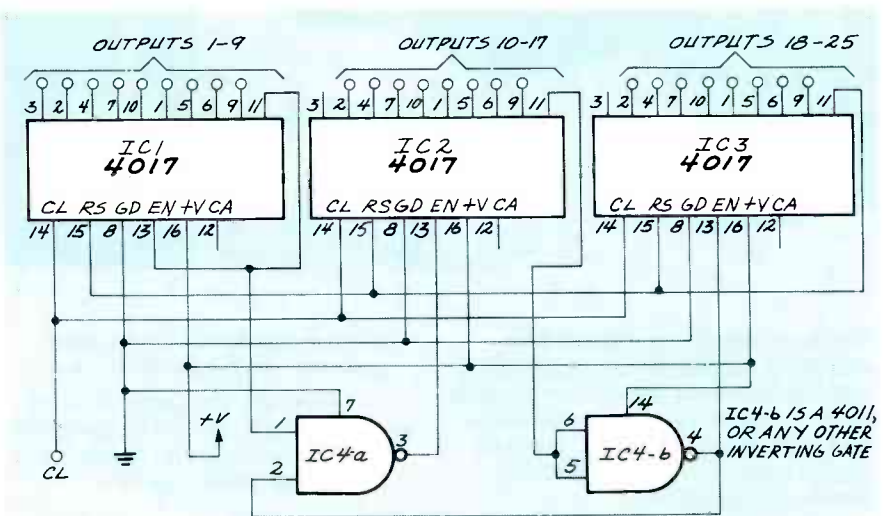

FIG. 2

4017's with a common clock and then have their outputs go high one after the other. In the ideal circuit, the first 4017 would respond to the first ten clock pulses, the second would handle the second ten, and so on. The seven-

teenth clock pulse, for example, would light the seventh LED on the second 4017.

The only two control pins on the 4017 are RESET and ENABLE, and even though they're the major players in designing the circuit, you can't

Cable Checklist

ENJOY CABLE TV MORE THAN EVER



SNOOPER STOPPER/DATA BLOCKER

\$39⁹⁵



- Prevent cable companies from spying on you to see how many cable converters you have
 - Removes beeping sound from your FM when radio is connected to cable TV
 - Cable TV descramblers are being sold by the thousands, but few people know descramblers can be detected on most addressable systems
- Maintain your privacy with a Snooper Stopper. For more detailed information, send \$2.00 for our "Cable TV Snooper Stopper" article.



MACROVISION... NOW YOU SEE IT, NOW YOU DON'T

MS1-KIT

\$29⁹⁵

Includes all the parts, pc board, AC adaptor, and instructions from a published construction article in *Radio Electronics* magazine.



- Remove copy-protection from video cassettes
- Digital filter type; removes only Macrovision pulses

JMAK-4 BLACK BOX

\$14⁹⁵

Original box as shown in ad with two feet and four holes to mount pc board.

- No adjustments; crystal controlled
- Compatible with all VCRs
- Uses automatic vertical blanking level
- Assembles in less than three hours



SIGNAL ELIMINATOR

\$29⁹⁵



- Works on cable or broadcast TV
- External adjustments allow precise tuning to any frequency
- #23 H-Tuneable to ch. 2 & 3 (50-66 Mhz) also 6 meter HAM TVI interference filter
- #46 FM-Tuneable to ch. 4-6 (66-108 Mhz & FM Band)
- #713-Tuneable to ch. 7-13 (174-216 Mhz)
- #1417-Tuneable to ch. 14-17 (A-D) (120-144 Mhz)
- #1822-Tuneable to ch. 18-22 (E-J) (144-174 Mhz)

ELIMINATE a Channel

that you find unsuitable for family viewing, but is poorly scrambled by your cable company. **OR**

CLEAR UP a Channel

that presently contains severe interference by ELIMINATING whatever signal is causing this.

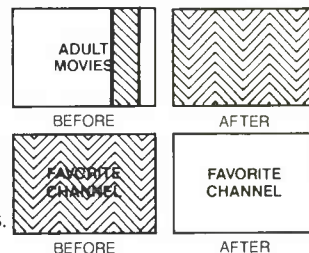

Note: If picture and sound are equally affected, this IS interference and CAN be removed by our product. If only picture is affected, this usually IS NOT interference and CANNOT be removed by our product.



72 Channel CABLE CONVERTER

with Infra-Red Remote

MC-702 Converter

\$79⁹⁵

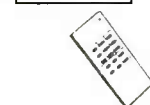

- Microprocessor controlled PLL operation
 - Skip channel memory eliminates unused channels
 - Parental control for all channels
 - Compatible with all external descramblers
 - Last channel recall
 - Fine tune memory
 - UL listed/FCC approved
 - Simple installation with any TV
 - Includes battery and 3 foot coax
 - Channel output 2 or 3 switchable
- Add \$3.50 shipping & handling
\$9.50 Canadian orders

ORDER TOLL FREE ANYTIME
1-800-227-8529

Inside MA: 508-695-8699 Fax: 508-695-9694

Ask for additional free information

Add \$3.00 shipping & handling on all orders unless otherwise noted. \$6.00 Canadian orders.

Visa, MasterCard, or C.O.D.



J & W
ELECTRONICS, INC.

P.O. BOX 800 • MANSFIELD, MA 02048

CIRCLE 65 ON FREE INFORMATION CARD

When performance & price really count...



Reliability & Quality
From Start To Finished Product

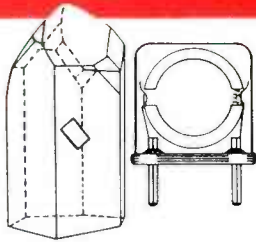

**QUARTZ
CRYSTALS/OSCILLATORS FOR
ELECTRONIC — INDUSTRIAL**

- Micro-Processor Control
- Computers/Modems
- Test/Measurement
- Medical

COMMUNICATIONS — REPLACEMENT

- Mobile/2-way/Channel Elements
- Pagers
- Marine
- Aircraft
- Telemetry
- Monitors/Scanners

AMATEURS

- CB
- Hobbist
- Experimenter

COST EFFECTIVE
MODERATE PRICING
FAST DELIVERY



Replacement Crystals Catalog

Custom Made Crystals Catalog

The Pulse of Dependable Communications

Crystek Crystals offers their new 16 page **FREE** catalog of crystals and oscillators. Offering state-of-the-art crystal components manufactured by the latest automated technology. Custom designed or "off the shelf," Crystek meets the need, worldwide. Write or call today!

CRYSTEK CORPORATION
DIVISION OF WHITEHALL CORPORATION

2351/2371 Crystal Dr. • Ft. Myers, FL 33907
P.O. Box 06135 • Ft. Myers, FL 33906-6135
TOLL FREE 1-800-237-3061
(813) 936-2109 — TWX 510-951-7448



CIRCLE 69 ON FREE INFORMATION CARD

get around the fact that no amount of logical glue is going to turn off all of the 4017 outputs. The only way to make that happen is to cut the power to the IC. That isn't as silly as it sounds, because the 4017, being a CMOS part, draws so little power that its +V input (pin 16) can be driven by a transistor. The transistor switch, in turn, can be toggled by the logic controlling the 4017's.

A simpler way to handle the problem is shown in Fig. 2. Three 4017's are used to provide 25 sequential outputs. There isn't room here to go through all the logic but you should draw up a truth table on your own to make sure that you understand how it works. Notice that the lack of a way to turn off the LED's has caused the loss of one output on the first 4017 and two outputs on the others.

If you use that circuit, be sure to pulse the RESET line when you power up, because the 4017 usually has an illegal (and silly) state at its outputs when you first turn it on. If you want to work out some way to

use all the outputs, try the transistor-switch approach I mentioned earlier.

TOUCH SWITCH

**I'm building a touch switch and I need a way to build a bistable using two op-amps in an LM324. Have you got a simple circuit that I can use?—
A. Askey, St. College, PA**

Just so that we all know what we're talking about here, I'm assuming that when you say "bistable" you mean an RS flip-flop. If that's the case, the easiest way to do the job would be to use a digital flip-flop and be done with it. The circuit would be a lot simpler, much more immune to noise, and you'd be using an IC that's specifically designed with that in mind.

But I suspect that you're using half of the 324 for the touch-switch oscillator and you want to keep the parts-count down by using the rest of the IC for the flip-flop. If that's the case you're on the right track, since minimizing the parts count is a good thing. If, on the other hand, that's the only job you want to do with the 324, it makes a lot more sense to use a TTL or CMOS flip-flop—believe it.

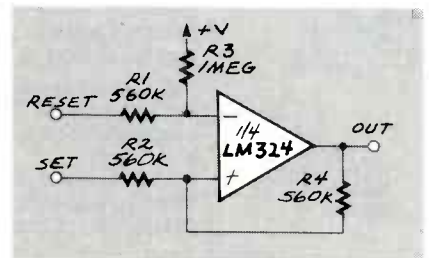

FIG. 3

Now that we understand each other, the answer is: Yes, it's not hard to build an astable around a 324. You may have two op-amps available in the IC, but if you take a look at Fig. 3, you'll see that you only need one to get the job done. A high pulse on the set input will drive the output high and it will stay that way because the resistor in the feedback loop, R4, causes the op-amp to latch up. If you put a positive pulse on the reset input, the output will drop very close to ground. How close to ground depends on the characteristics of the particular op-amp, but it will easily be within a couple of millivolts of ground level. **R-E**

**ATTENTION!
ELECTRONICS
TECHNICIANS**



**EARN YOUR
B.S.E.E.
DEGREE**

THROUGH HOME STUDY

Our New and Highly Effective Advanced-Placement Program for experienced Electronic Technicians grants credit for previous Schooling and Professional Experience, and can greatly reduce the time required to complete Program and reach graduation. No residence schooling required for qualified Electronic Technicians. Through this Special Program you can pull all of the loose ends of your electronics background together and earn your B.S.E.E. Degree. Upgrade your status and pay to the Engineering Level. Advance Rapidly! Many finish in 12 months or less. Students and graduates in all 50 States and throughout the World. Established Over 40 Years! Write for free Descriptive Literature.

**COOK'S INSTITUTE
OF ELECTRONICS ENGINEERING**

 4251 CYPRESS DRIVE
JACKSON, MISSISSIPPI 39212

CIRCLE 58 ON FREE INFORMATION CARD

LETTERS



LASER PROJECTS

Readers who enjoyed my article entitled "Universal Laser Power Supply" (*Radio-Electronics*, March 1989) might find my new book, *The Laser Cookbook: 88 Practical Projects*, to be helpful in applying lasers in real-world uses. The book presents numerous hands-on projects in helium-neon and semiconductor laser technology, including holography, light shows, seismology, and optics. It also provides additional information on helium-neon laser testing, opera-

tion, and use. The book is published by TAB Books (catalog No. 3090).

GORDON McCOMB
Canoga Park, CA

MONEY-MAKING TIPS

I contacted Marcie Swampfelder about the mass-transference transmitter and receiver that appeared in "Hardware Hacker" (*Radio-Electronics*, April 1989). At first, I was skeptical, but it really does work as advertised.

The only problem is that it is not

quite economical to run in an attended mode. You can get a dollar out for every quarter you put in, but it takes slightly more than 12 minutes. Frankly, I can make better money picking rags at the dump.

So, I got a Heathkit Robotics Experimenter set, which I eventually programmed to take a quarter from a stack and put it in the transmitter unit. I tried mounting the receiving units on a slanted board, but found that the quarters would slip out before they were fully

With Just One Probe Connection, You Can Confidently Analyze Any Waveform To 100 MHz, 10 Times Faster, 10 Times More Accurately, Absolutely Error Free, Guaranteed — Or Your Money Back!

SC61 Waveform Analyzer™
Patented
\$3295



There are other digital readout oscilloscopes, but none of them completely eliminate graticule counting and calculations like the SC61 Waveform Analyzer. The innovative, time-saving AUTO-TRACKING™ digital readout automatically gives you every waveform parameter you need for fast troubleshooting.

The SC61 Waveform Analyzer is a triple patented high performance scope that provides you with a digital LCD read-out of all key waveform parameters (DC volts, peak-to-peak volts, and frequency) at the push of a button, and all with one probe connection.

Other time-saving features include exclusive ECL sync circuits that allow you to lock quickly onto waveforms up to 100 MHz. Plus, with 3000 volts of input protection, you never have to worry about an expensive front end repair job.

Call **1-800-843-3338** to find out more about what the SC61 can do for your service business. In Canada call **1-800-851-8866**.

SENCORE

3200 Sencore Drive, Sioux Falls, SD 57107

100% American Made

CIRCLE 177 ON FREE INFORMATION CARD

Put Professional Knowledge and a
COLLEGE DEGREE
 in your Technical Career through
HOME STUDY

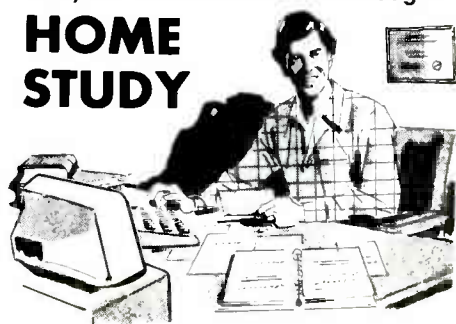

Add prestige and earning power to your technical career by earning your Associate or Bachelor degree through directed home study.

Grantham College of Engineering awards accredited degrees in **electronics and computers.**

An important part of being prepared to *move up* is holding the right college degree, and the absolutely necessary part is knowing your field. Grantham can help you both ways—to learn more and to earn your degree in the process.

Grantham offers two degree programs—one with major emphasis in **electronics**, the other with major emphasis in **computers**. Associate and bachelor degrees are awarded in each program, and both programs are available completely by correspondence.

No commuting to class. Study at your own pace, while continuing on your present job. Learn from easy-to-understand lessons, with help from your Grantham instructors when you need it.

Write for our free catalog (see address below) or telephone us at (213) 493-4421 (no collect calls) and ask for our "degree catalog."

Accredited by
 the Accrediting Commission of the
 National Home Study Council

GRANTHAM
College of Engineering
 10570 Humbolt Street
 Los Alamitos, CA 90720

TOROIDAL TROUBLE

For those of you who built the high-power audio amplifier (*Radio-Electronics*, March 1989), you may have had some trouble getting the 12-volt DC power supply working if you tried to wind the toroidal transformer yourself. On page 53 the article stated that the turns ratio between the secondary and the primary was 5-to-1. It also stated on page 55 that the secondary was 19 turns center-tapped, and that the primary was 14 turns center-tapped. That, as you can see, is not a 5-to-1 ratio.

As it turns out, the specifications given for the transformer were mostly incorrect. To start with, the core should be part

number 52029-1D, *not* 50029-1D. As for the turns, the primary should be 14 turns center-tapped, 12-gauge wire; the base drive should be 6 turns, center-tapped, 16-gauge wire; and the secondary should be 38 turns, center-tapped, 14-gauge wire.

When making a center-tapped winding, it is best to use two equal-length pieces of wire, each wrapped half the number of total turns, and twisted together at the center tap. That not only makes it easier to make the windings, but it also makes for a well-balanced transformer. Sorry we couldn't tell you in the first place.—*Editor*

formed. I had to build a gate, operated by a solenoid, to keep them in.

It works, but I'm still not satisfied with it. I learned the hard way that you have to be very exact in timing the robotic arm. One day I woke up to find that the transmitter unit had energized while the tip of one of the robot's fingers was still in it. Naturally, the robot picked up the fingertip from one of the receivers and stuck it back into the transmitter, so I ended up with a pile of fingertips and no quarters.

Has anyone come up with a patch to get those units to run on the GS?

GARETH TUCKER
 Deep River, CT

ATARI FAN

I want to express my gratitude to you for publishing the story on the Atari ST in February's *ComputerDigest* section. As a 520 STowner, I have never understood why that powerful, fast, and inexpensive computer hasn't become the home computer of choice in the United States (as it seemingly has in Europe). Indeed, it can emulate the Macintosh (at full speed and with improved graphics) or the PC, but it has so many features of its own that it is nicer to use in and of itself. Additionally, software for the ST is plentiful and generally less expensive.

I hope to see more coverage of

that versatile machine in future issues of *Radio-Electronics*.

PETER BARNES
 Winchester, MA

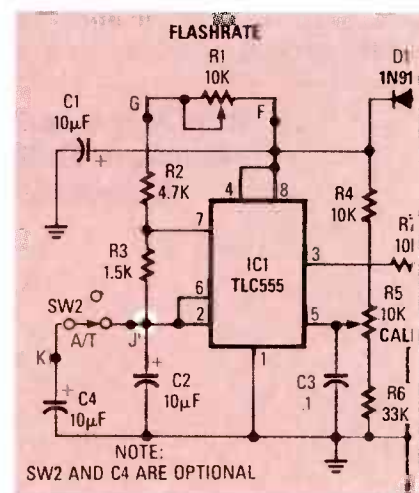

FIG. 1

DOT'S WHAT'S MISSING

Who would believe it? You know those little dots on our schematics that indicate whether or not there is a connection between two intersecting lines? Well, it seems that one of those dots decided to pack it in early, leaving Fig. 1 of the Alpha/Meditation Goggle story (*Radio-Electronics*, April 1989) with a definite dot deficiency.

The missing dot belongs at the intersection of R3, C2, and pins 2 and 6 of IC1. We have reprinted a portion of the original schematic, along with the correction, in Fig. 1 above.—*Editor*

R-E

EQUIPMENT REPORTS

Lynx 470 Disk Drive Tester and Exerciser

Who says you can't service floppy-disk drives?

CIRCLE 28 ON FREE INFORMATION CARD



MOST COMPUTER-REPAIR SERVICE calls consist of removing one board and replacing it with another. Even disk-drive problems are "solved" by replacing the drive. Whether the drive problems show up as read errors, write errors, or seek errors, they're usually caused by improper alignment. By some estimates, up to 90% of all

drive problems are caused by misalignment!

We've recently found equipment that will allow a service center to reduce its inventory of drives and at the same time cut down on inexpensive, inefficient round trips between your customers and your service depot: the Lynx 470 from Lynx technology (1241 De-

nison Street, Markham, Ontario, Canada L3R 4B4; distributed in the U.S. by HMC, P.O. Box 526, Canton, MA 02021). The 470 allows you to solve most disk-drive problems on-site. A floppy-disk drive can be aligned in minutes!

The 470 will work with all 3½-, 5¼-, and 8-inch drives, although adapters are required for some, such as the Commodore 1541. The tester is designed to be used with standard alignment disks; it digitizes the analog signal from the alignment disk so that an oscilloscope is unnecessary.

The tester doesn't need its own power supply—it gets its power from the drive under test. When the tester is used, it takes complete control of the drive, taking the place of the disk controller.

Some 25 rocker switches let you control the tester's various functions, and 39 high-intensity LED's report on the status of the tester and the results of various tests.

continued on page 32

Mark-V SM-333 Surround Sound Processor

Bring movie-theater sound to your living room!

CIRCLE 29 ON FREE INFORMATION CARD



THE VCR BROUGHT FEATURE FILMS AND convenient viewing times into American homes more than a decade ago. Stereo TV, introduced only six years ago, brought a greater realization of how a sound track can enhance the TV viewing experience. Although surround-sound processors have been available for several years, they have yet to catch on to any great extent. We think, however, that once people learn about them, family rooms across the country will be converted into home movie theaters with surround-sound processors like the SM-333 from Mark-V Elec-

tronics (8019 E. Slauson Avenue, Montebello, CA 90640).

If you're not convinced that surround sound adds much to the viewing experience, try to remember the last time you watched on TV, a movie you had previously seen at a theatre equipped with Dolby Surround. *Star Wars* just wasn't the same, was it? It's not just the smaller screen and aspect ratio that gives movies on TV that small feeling—it's small sound, too.

The SM-333 can expand your enjoyment of watching TV by expanding the depth of the accompanying sound. Although interest-

ing effects can be produced even with monaural inputs, true surround sound requires stereo inputs from sources encoded with Dolby-Surround.

Most tapes that you rent at your local video store are recorded in stereo and include Dolby Surround encoding. If an encoded movie is broadcast by a TV station in stereo, you can also decode the surround channel if you have an MTS stereo decoder as well as a surround-sound processor.

Hooking it up

Provisions for three sets of line-level stereo inputs are included on the SM-333. Two sets of stereo outputs are provided for connection to front and rear amplifiers. The signals for the front channels are fed straight through a unity-gain amplifier to the output, unless DNR (Dynamic Noise Reduction)

continued on page 32

Take any one of these HANDBOOKS ELECTRONICS and CONTROL

- your one source for engineering books from over 100 different publishers
- the latest and best information in your field
- discounts of up to 40% off publishers' list prices

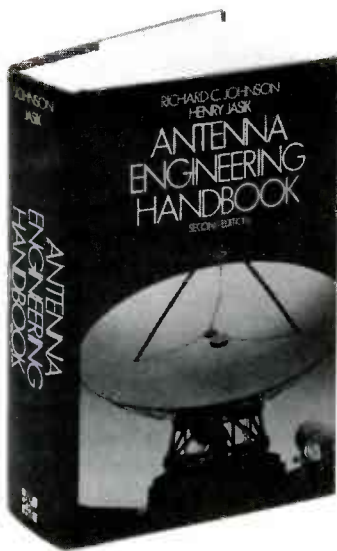

322/910

Publisher's Price \$110.00

ANTENNA ENGINEERING HANDBOOK, Second Edition

Edited by R. C. Johnson and H. Jasik

- 1,408 pages, 946 illustrations
- covers all types of antennas currently in use with a separate chapter devoted to each
- provides detailed data on physical fundamentals, operating principles, design techniques, and performance data
- up-to-the-minute information on antenna applications
- a must for those involved in any phase of antenna engineering

Publisher's Price \$68.00

STANDARD HANDBOOK OF ENGINEERING CALCULATIONS, Second Edition

By T. G. Hicks

- 1,468 pages, 793 illustrations, 499 tables
- puts more than 1,100 specific calculation procedures at your fingertips
- every calculation procedure gives the exact, numbered steps to follow for a quick, accurate solution
- virtually all procedures can be easily programmed on your PC or calculator
- uses USCS and SI units in all calculation procedures

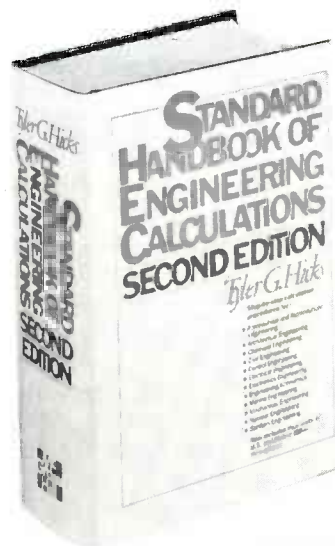

287/35X



047/790

Publisher's Price \$95.50

TELEVISION ENGINEERING HANDBOOK

Edited by K. B. Benson

- 1,478 pages, 1,091 illustrations
- packed with all the technical information today's engineer needs to design, operate and maintain every type of television equipment
- extensive coverage of receivers, broadcast equipment, video tape recording, video disc recording, and the latest technological advances
- provides television system and industry standards for the U.S. and other countries
- the most comprehensive book on the subject of television engineering

for only \$14.95 – when you join the ENGINEERS' BOOK CLUB

values up to \$110.00

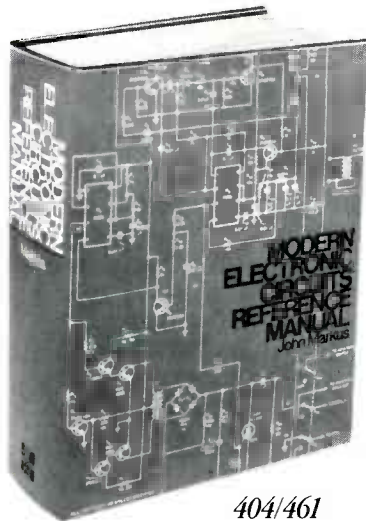

404/461

Publisher's Price \$85.50

MODERN ELECTRONIC CIRCUITS REFERENCE MANUAL

By J. T. Markus

- 1,264 pages, 3,666 circuit diagrams
- a handy, desktop reference with 103 chapters organized by "family" grouping
- filled with predesigned and use-tested circuits to save you production time and money
- includes concise summaries of all the recent applications notes, journal articles, and reports on each circuit, efficiently organized and indexed for the practicing engineer



4 reasons to join today!

1. Best and newest books from ALL publishers! Books are selected from a wide range of publishers by expert editors and consultants to give you continuing access to the best and latest books in your field.

2. Big savings! Build your library and save money, too! Savings range up to 40% off publishers' list prices.

3. Bonus books! You will automatically be eligible to participate in our Bonus Book Plan that allows you savings up to 70% off the publishers' prices of many professional and general interest books!

4. Convenience! 14-16 times a year (about once every 3-4 weeks) you receive the Club Bulletin FREE. It fully describes the Main Selection and alternate selections. A dated Reply Card is included. If you want the Main Selection, you simply do nothing – it will be shipped automatically. If you want an alternate selection – or no book at all – you simply indicate it on the Reply Card and return it by the date specified. You will have at least 10 days to decide. If, because of late delivery of the Bulletin you receive a Main Selection you do not want, you may return it for credit at the Club's expense.

As a Club member you agree only to the purchase of two additional books during your first year of membership. Membership may be discontinued by either you or the Club at any time after you have purchased the two additional books.

Publisher's Price \$86.50

STANDARD HANDBOOK FOR ELECTRICAL ENGINEERS, Twelfth Edition

Edited by D.G. Fink and H.W. Beaty

- 2,416 pages, 1,388 illustrations, 430 tables
- the essential reference for all electrical engineers
- ranges from basic circuits and measurements to advanced topics, such as power distribution and telecommunications
- fully updated to cover all recent advances and developments
- written and compiled by 115 contributors – all experts in their fields

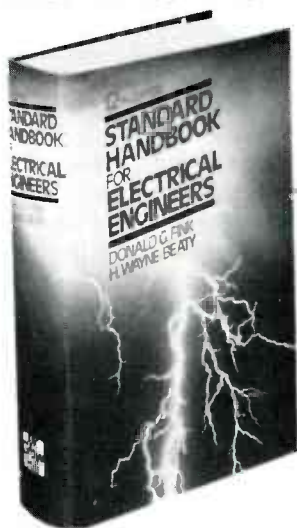

209/758

FOR FASTER SERVICE IN ENROLLING CALL TOLL FREE 1-800-2-MCGRAW

McGraw-Hill Book Clubs
Electronics and Control Engineers' Book Club®
 P.O. Box 582
 Hightstown, NJ 08520-9959

Please enroll me as a member of the Electronics and Control Engineers' Book Club® and send me the book I have chosen for only \$14.95 plus local tax, postage and handling. I agree to purchase a minimum of two additional books during my first year as outlined under the Club plan described in this ad. Membership in the club is cancellable by me or McGraw-Hill any time after the two book purchase requirement has been fulfilled. A shipping and handling charge is added to all shipments.

I wish to order the following book:

- ANTENNA ENGINEERING HANDBOOK (322/910)
- MODERN ELECTRONIC CIRCUITS REFERENCE MANUAL (404/461)
- STANDARD HANDBOOK FOR ELECTRICAL ENGINEERS, 12/e (209/758)
- TELEVISION ENGINEERING HANDBOOK (047/790)
- STANDARD HANDBOOK OF ENGINEERING CALCULATIONS (287/35X)

Signature _____

Name _____

Address/Apt. # _____

City/State/Zip _____

This order subject to acceptance by McGraw-Hill. Offer good only to new members. Foreign member acceptance subject to special conditions.

E34025

NEW PRODUCTS



CIRCLE 10 ON FREE INFORMATION CARD

SOLDERING GUN. A new cordless soldering gun, the Z-50 from Zimac Laboratories, Inc, is built to stand up to the rigors of industrial use, and features a recharging holster and a unique tip (shown below). The most significant feature of the Zimac gun is its quick heating time, thanks to its boron carbide heating element. Its rapid cycling time is helped by the placement of its temperature sensor right at the tip.

If you've had experience with battery-operated or butane-fueled soldering irons in the past, you might not believe that portable soldering irons are much of a convenience. However, we've had an early version of the Z-50 on hand for more than half a year, and have

found it to work flawlessly. We found it to be perfect for field service. (Repairing a car stereo was possible without even removing the stereo unit from the car!)

The heat capacity of the gun is also impressive. We have tried soldering large-gauge wires (No. 4 and No. 6) with success.

For the hobbyist, the Zimac gun removes the temptation not to solder a joint because of the normal inconvenience. It makes it possible to make connections that were previously difficult or impossible—for example, a connector up on an antenna tower.

The Z-50 has a suggested retail price in the U.S. of \$69.95.—Zimac Laboratories, Inc., Ballard Mill, S. Williams St., Malone, NY 12953.

TV/VCR COMBINATION. Casio's VF-3100 pairs a UHF/VHF TV set with a VCR that plays standard VHS tapes and can record in either standard or extended mode. The high-resolution TV set features a 3.3-inch screen. Designed for portability, the compact unit measures just $10\frac{3}{8} \times 7\frac{1}{2} \times 4$ inches, weighs only 6.6 pounds, and can run off a battery pack, household current, or, used with optional adaptors, a car battery.



CIRCLE 11 ON FREE INFORMATION CARD

Other features include a tiltable base and a sleep/timer function that allows the unattended recording of up to two hours of programming. The TV/VCR has a built-in speaker, a rod antenna, a video I/O jack, an audio I/O jack, and jacks for earphones, external power, and antenna.

The VF-3100 combination TV/VCR has a suggested retail price of \$999.00.—Casio, Inc., 570 Mt. Pleasant Avenue, P.O. Box 7000, Dover, NJ 07801.

AMPLIFIED SPEAKER. Designed specifically for use with handheld radios, Naval Electronics' HTS-1 is a compact speaker with a 10-dB internal amplifier. It can run on batteries or through a DC jack on 6–15 volts DC, and even has built-in Ni-Cd battery charger. The HTS-1 also features automatic shut-off, which conserves batteries by killing power to the amplifier when there is no audio input. When it is switched off manually, the amp is

ZIMAC TEMPERATURE CONTROLLED N.T.C. SOLDERING TIP

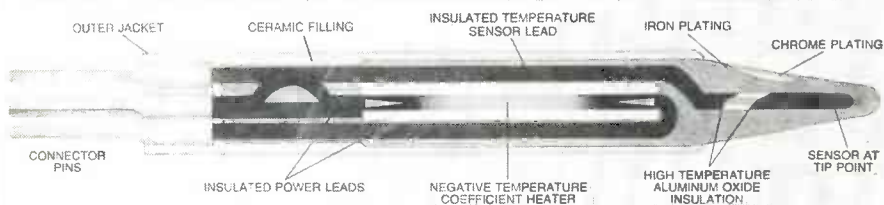



CIRCLE 12 ON FREE INFORMATION CARD

bypassed and the input jack is connected directly to the speaker.

With its tilted base, the HTS-1 can be mounted on a desk; for mounting on a car door, a special mobile harness is available. A 5-foot cable with mini-plugs and a stereo-to-mono converter is included. When two units are purchased together for use with a personal-stereo system, a free stereo cable is also included.

The HTS-1 costs \$29.95.—Naval Electronics, Inc., 5417 Jetview Circle, Tampa, FL 33634.

RECORDER ACTIVATOR. The Nitellogger allows unattended, professional-quality recording of transmissions received on any scanner radio or other receiver, by providing connection to a standard cassette-tape recorder. The receiver must have a remote-speaker jack and the recorder must have remote-microphone capability. All necessary connector cables are included.

The Nitellogger lets the user listen during recording, and a built-in volume control adjusts the loudness independent of record-



CIRCLE 13 ON FREE INFORMATION CARD

ing levels. For silent recording, the speaker can be turned all the way down. A VOX-level lamp lights when the incoming audio is sufficient for proper operation. To conserve tape, the unit's variable dropout-delay control can be used to determine how long the recorder should run after a transmission has ended.

The Nitellogger scanner-recorder activator costs less than \$70.00.—Benjamin Michael Industries, Inc., 1139 East Tower Road,

Schaumburg, IL 60173; 312-884-7077.

SCIENTIFIC CALCULATOR. The TI-68—targeted at college students and professionals in the fields of mathematics, science, and engineering—performs 254 functions, including 40 complex-number functions. The calculator solves up to 5 simultaneous equations and has powerful formula-programming capabilities. For ease of use, it features plain-En-

Joseph Electronics' 40th Anniversary Specials!

Special INSTRUMENT SALE!



Model 2120 Oscilloscope
DC to 20 MHz. Dual Trace, 6" CRT, 1mv Sensitivity.
Reg. \$520 **\$379.40**
40TH ANNIVERSARY PRICE

- | | | |
|--|---|---|
| <p>Model 2125 Oscilloscope Same great features as 2120, except with delayed sweep Reg. \$620 \$519.40 40TH ANNIVERSARY PRICE</p> <p>Model 1541A Oscilloscope OC to 40 MHz, Dual Trace, 6" CRT 1mv Sensitivity Reg. \$845 \$739.40 40TH ANNIVERSARY PRICE</p> <p>Model 2160 Oscilloscope DC-60MHz, dual trace, delay sweep, 6" CRT, 1mv sensitivity Reg. \$995 \$839.40 40TH ANNIVERSARY PRICE</p> <p>Model 2520 Digital Storage 20MHz, Dual Trace, 2mv Sens. Reg. \$1990 \$1795.40 40TH ANNIVERSARY PRICE</p> <p>Model 2521 Digital Storage 20MHz, Dual Trace CRT Readout, Cursors, RS232 Interface Reg. \$3050 \$2745.40 40TH ANNIVERSARY PRICE</p> | <p>Model 1249 NTSC/RGB Color Bar Generator, Composite Video Output, RF Output Reg. \$499 \$419.40 40TH ANNIVERSARY PRICE</p> <p>Model 2009 MTS TV Stereo Generator Ideal for Stereo TV, Receivers, VCR's and Stereo Adapter Service Reg. \$499 \$419.40 40TH ANNIVERSARY PRICE</p> <p>Model 2830 3 1/2 DIGIT LED BENCH Multimeter .5 DCV Accuracy, ALL 33 Ranges and Functions are Push Button Selectable Reg. \$243 \$209.40 40TH ANNIVERSARY PRICE</p> <p>Model 1045 Telephone Product Tester Provides Basic Operation Tests for Corded and Cordless Telephones, Answering Machines and Automatic Dialers Reg. \$495 \$415.40 40TH ANNIVERSARY PRICE</p> <p>Model 1803 Frequency Counter 100 MHz, 8 digit display, zero blanking AC or Battery Reg. \$199 \$169.40 40TH ANNIVERSARY PRICE</p> | <p>Model 2005 RF Signal Generator 100 KHz to 150 MHz, in 6 fundamental bands and 450 MHz in harmonics Reg. \$195 \$165.40 40TH ANNIVERSARY PRICE</p> <p>Model 3011 Function Generator 2 MHz, 4 digit display, TTL & CMOS pulse outputs Reg. \$239 \$199.40 40TH ANNIVERSARY PRICE</p> <p>Model 1630 DC Power Supply 0-30V, 0-3A, high-low current range, Low ripple Reg. \$251 \$209.40 40TH ANNIVERSARY PRICE</p> <p>Model 1601 DC Power Supply isolated 0-50V, 0-2A in ranges, fully automatic shutdown, Adj. current limit Reg. \$463 \$389.40 40TH ANNIVERSARY PRICE</p> <p>Model 1650 Triple Output Power Supply two 0-25 VDC @ .5A and 5VDC @ 5A, fully automatic shutdown Reg. \$489 \$409.40 40TH ANNIVERSARY PRICE</p> <p>Model 1653 AC Power Supply variable isolated 0-150 VAC @ 2A, built-in isolation transformer Reg. \$200 \$169.40 40TH ANNIVERSARY PRICE</p> |
|--|---|---|

NEW! Model 388-HD Hand-held 3 1/2 Digit LCD TEST BENCH

41 voltage ranges, frequency counter, capacitance meter, logic probe, transistor and diode tester. All packed into a drop-resistant case. **SPECIAL PRICE!**

Reg. \$139 **\$119.40**



We are celebrating our 40th Anniversary by offering you huge savings on B&K Test Equipment.

Send for FREE 528 page "Industrial Products Catalog." I understand it is FREE with any order or if requested on company letterhead. (Otherwise, \$4.95 to cover catalog and shipping costs.)

ORDER TOLL FREE
1-800-323-5925
IN CHICAGOLAND
312-297-4200
FAX: 312-297-6923



IL Res. 7% Tax

JOSEPH ELECTRONICS, INC. Dept. R
8830 N. Milwaukee Ave., Niles, IL 60648

Rush merchandise per attached order. I understand rated accounts are shipped open account; otherwise send per credit card.
Include \$5.00 per item for shipping and handling.
 Visa Master Card Discover
 Check Money Order Rush Catalog
Card No. _____ Exp. Date _____

Name _____
Company _____
Street Address _____
City _____ State _____ Zip _____

MAY 1989

lish prompting, an alpha display, simple programming of formulas, and straightforward number entry for complex numbers.



CIRCLE 14 ON FREE INFORMATION CARD

The TI-68 also offers last-equation recall; up to 36 memory regis-

ters; one- and two-variable statistical functions; decimal, hexadecimal, octal, and binary numbers; number-base and 18 other conversions; and Boolean logic operations. It comes with a 184-page guidebook and a quick-reference card that provides a convenient function summary. A sliding case protects the calculator from damage.

The TI-68 advanced scientific calculator has a suggested retail price of \$65.00.—Texas Instruments, Consumer Relations, P.O. Box 53, Lubbock, TX 79408; 806-747-1882.

VOLTAGE-SURGE SUPPRESSOR. Perma Power's PTC-209 "Cable-Line" protects electronic equipment from transient voltage surges on television cables or receiving antennas, as well as on the AC power line. It can be used on antenna wire or satellite lead-in wires to safeguard television sets, VCR's, cable converters, satellite receivers, and stereo equipment—with no significant loss of picture



CIRCLE 15 ON FREE INFORMATION CARD

signal. The PTC-209, which features gold-plated connectors, won't cause a snowy picture quality, or loss of picture, even in the UHF frequencies.

The 3½- × 4¾- × 2¼-inch unit plugs into any grounding-type outlet, and features an automatic-shutdown feature that disconnects

Blister, Boxed or Bulk packed. With all the benefits of 3M.

Your Electronic Specialty Products distributor has a wide selection of 3M Electrical, Electronic and Telecommunications products in quantities from one to 1,000.

Sometimes you need less than industrial quantities. But you still demand quality. We've got all kinds of products for test and measurement, interconnection, static control, circuit-building and prototyping and more.

For maintenance and repair professionals, professional engineers, technicians, hobbyists, students and educators. Get a wide

selection of products with the 3M quality you expect, in the quantities you need. From single packages to bulk packs.

For the name of your nearest Electronic Specialty Products distributor, call toll free 800-321-9668 or (216) 354-2101 in Ohio.

**Electronic Specialty Products,
3M Electronic Products Division**

9325 Progress Parkway
Mentor, OH 44060

We've Packaged Our Solutions.

CIRCLE 76 ON FREE INFORMATION CARD



3M

Worldwide Sponsor
1988 Olympic Games



NEW

POCKET SIZE

SIZE: 4" H x 3.5" W x 1" D
MADE IN USA

OPTOELECTRONICS INC.

FREQUENCY COUNTERS TO 2.4 GHZ

8 LED DIGITS • 2 GATE TIMES
ALUMINUM CABINET
INTERNAL NI-CAD BATTERIES INCLUDED
AC ADAPTER/CHARGER INCLUDED

#TA-100S



EXCELLENT SENSITIVITY & ACCURACY

AC-DC • PORTABLE OPERATION

Small enough to fit into a shirt pocket, our new 1.3 GHz and 2.4 GHz, 8 digit frequency counters are not toys! They can actually out perform units many times their size and price! Included are rechargeable Ni-Cad batteries installed inside the unit for hours of portable, cordless operation. The batteries are easily recharged using the AC adapter/charger supplied with the unit.

The excellent sensitivity of the 1300H/A makes it ideal for use with the telescoping RF pick-up antenna; accurately and easily measure transmit frequencies from handheld, fixed, or mobile radios such as: Police, firefighters, Ham, taxi, car telephone, aircraft, marine, etc. May be used for counter surveillance, locating hidden "bug" transmitters. Use with grid dip oscillator when designing and tuning antennas. May be used with a probe for measuring clock frequencies in computers, various digital circuitry or oscillators. Can be built into transmitters, signal generators and other devices to accurately monitor frequency.

The size, price and performance of these new instruments make them indispensable for technicians, engineers, schools, Hams, CBers, electronic hobbyists, short wave listeners, law enforcement personnel and many others.

STOCK NO:

- #1300H/A Model 1300H/A 1-1300 MHz counter with preamp, sensitivity, < 1mV, 27MHz to 450MHz includes Ni-Cad batteries and AC adapter \$169.95
- #2400H Model 2400H 10-2400 MHz microwave counter includes Ni-Cad batteries and AC adapter \$299.95
- #CCA Model CCA counter/counter, for debugging, ultra sensitive, < 50 micro volts at 150MHz! 1-600 MHz with adjustable threshold, RF indicator LED. Includes Ni-Cad batteries and AC adapter \$299.95

ACCESSORIES:

- #TA-100S Telescoping RF pick-up antenna with BNC connector \$12.00
- #P-100 Probe, direct connection 50 ohm, BNC connector \$20.00
- #CC-12 Carrying case, gray vinyl with zipper opening. Will hold a counter and #TA-100S antenna. \$10.00



ORDER FACTORY DIRECT
FLA (305) 771-2050 **1-800-327-5912**



AVAILABLE NOW!



OPTOELECTRONICS INC.

5821 N.E. 14th Avenue
Ft. Lauderdale, Florida 33334

Orders to US and Canada add 5% of total (\$2 min, \$10 max)
Florida residents add 6% sales tax. COD fee \$2.
Foreign orders add 15%

CIRCLE 189 ON FREE INFORMATION CARD

the power line if the suppressor circuit should fail (although it is designed to have a virtually unlimited lifetime, even when subjected to frequent or high surges). It is rated at 1800 watts, with a let-through voltage of less than 2 volts.

The *PTC-209* Cable-Line surge protector costs \$59.90.—**Perma Power Electronics, Inc.**, 5601 W. Howard Avenue, Chicago, IL 60648.

HOME-SECURITY SYSTEM. *Heath Zenith's SS-6100* is an affordable wireless system that is fully expandable. Dubbed a "supervised" system, it regularly performs self-checks to verify that all components are functioning properly, and it programs its own unique security codes.

The *SS-6100* includes a control center, a lamp module, a door/window sensor, and a remote control that arms and disarms the loud alarm in the control center. The

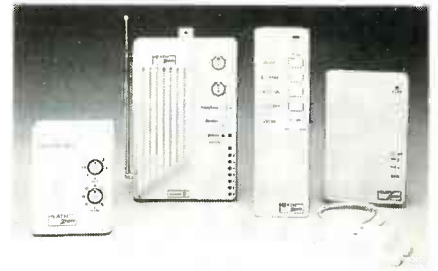

CIRCLE 16 ON FREE INFORMATION CARD

control center also has LED's that indicate in which area the disturbance is occurring, and battery back-up for continued protection in the event of a power failure.

Designed to be easily installed by the user, the system can be expanded to as many as 16 zones of coverage. Available accessories include: additional lamp modules, command units, door/window sensors, a remote siren/dialer connection, an automatic dialer, motion sensors, and lastly a remote dimmer/controller.

The *SS-6100* wireless, supervised home-protection system has a suggested retail price of \$99.95.—**Heath/Zenith**, Consumer Products Group, Hilltop Road, St. Joseph, MI 49085.

ROUND-CABLE CUTTER. *Paladin's PA 1818* cuts large-scale and multiple cables, up to 750-MCM copper, 1000-MCM aluminum, or 300 pair of copper. Its small size and ergonomic design allow easy one-handed cutting.



CIRCLE 17 ON FREE INFORMATION CARD

Other features include a molded, non-slip handle and a locking latch that folds for safety. The *PA 1818* also includes a release mechanism, which allows the user to move the tool to another cutting area.

The *PA 1818* round-cable cutter lists for \$239.00.—**Paladin Corporation**, 3543 Old Conejo Road, Suite 102, Newbury Park, CA 91320.

MICROPHONE/MIXER. With *Ambico's Model V-0628* "Mike &



TPI Probes Last Longer, Cost Less

Unique flexible cable and superior strain relief give longer life and easier, more comfortable handling

Order from these distributors:

- Active
- Allan Crawford Assoc.
- Allied Electronics
- CALCOTRON
- contact east
- EIL Instruments
- ELECTRA TEST
- Electronic Parts Co.
- ELECTROTEX
- Jensen Tools
- JOSEPH Electronics
- Marshall Industries
- Mc Master-CARR
- Metermaster
- RADAR Electric Co.
- Southeastern Electronics
- Specialized Products Co.
- TECHNI-TOOL
- Westcon Inc.
- Wm. B. Allen

**TEST
PROBES, INC.**

TPI

9178 Brown Deer Road. San Diego, CA 92121
Call tool free for information and free catalog:
1-800-368-5719
1-800-643-0382 in CA

CIRCLE 123 ON FREE INFORMATION CARD

Mixer," you can add a rich soundtrack to any video. It accepts 4 inputs, providing full control over the relative volume of each; a master volume control adjusts the overall volume level of the four inputs. All four sources can be played simultaneously, or you can fade in and out between them. The dynamic microphone (which requires no batteries) plugs into one of the inputs, making it easy to add narration.



CIRCLE 18 ON FREE INFORMATION CARD

The model V-0628 Mike & Mixer has a suggested retail price of \$49.95.—Ambico, Inc., 50 Maple Street, Norwood, NJ 07648.

SPEECH DIGITIZER. The *Speech Thing* from Covox is an inexpensive hardware device that allows IBM educational talking software, and other brands of speech-coded software, to operate without a plug-in speech board. The device, which resembles a gender changer, attaches externally at the parallel-printer port and does not affect printer functions. It works with all IBM PC's and compatibles, including laptops. All digitized or synthesized speech and sounds from software sound files are converted to analog format for high-fidelity output. The *Speech Thing* package includes a speaker with volume control, demo software, and instructions.

Also available from Covox is the *Voice Master* PC digitizer with voice recognition (not pictured here). The hardware/software development system, which requires MS-DOS 2.1 or greater, 256K RAM, and the *Speech Thing* for audio playback, provides digital recording of speech, sound, and music, and offers full graphic editing ca-

ULTRA SMALL, ULTRA POWERFUL DMM

SOAR 3060



Actual Size: 2" w X 4 1/8" h X 3/8" th

AT YOUR FINGERTIPS

3200 Count, Full Scale, With Analog Bar Graph Display, 3 1/2 Digits, \$44⁹⁵ LIST

Go Ahead! Carry the model 3060 in your shirt pocket and use it single handedly! But first... check these heavy duty features: high speed auto/manual ranging; high speed sampling for 32 segment Analog Bar Graph; digital indicator; Auto-Power shut-off feature for extra long battery life; low power consumption; plus range hold & continuity beeper.

CARLO GAVAZZI
Instruments

The 3060 measures AC and DC Volts; also measures Ohms and tests diodes. It is supplied with carrying case to help protect against accidental drop problems; "button" cell batteries and test leads that you can't lose. Here's an exceptional, on-the-spot test instrument for every field "tech" kit.

Send For New 1989 Catalog
CG Instruments Corp.

434 Windsor Park Drive, Dayton, OH 45459
Tel: (513) 434-6952 • FAX: 513-434-7643

CIRCLE 188 ON FREE INFORMATION CARD

capabilities. Designed for both experimenters and software writers, it can be used for spoken advisories in business software; instrumentation, language, and other educational training; electronic voice store and forwarding; artificial intelligence applications; and to program ROM's for stand-alone talking robots or toys.

The *Voice Master* hardware comprises a short plug-in board (with external ports for microphone and line-level inputs) that contains a pre-amp and an 8-bit A/

D converter. A high-gain, flat-response electret microphone is also included. Speech-recording software includes a graphics-based editor for cutting and pasting of the sound waveform and a real-time digital oscilloscope for viewing the incoming waveform. Results can be saved to disk and linked, to form disk sound files for use with user-written programs. Speech recognition software is also included; the system can recognize 64 user-trained words or phrases.

The *Speech Thing* costs \$49.95; the *Voice Master* costs \$89.95.—**Covox Inc.**, 675 Conger St., Eugene, OR 97402.



CIRCLE 19 ON FREE INFORMATION CARD

SCOPE CART. The model 997 scope cart from Kikusui has a compact design, yet is large enough to move an entire test or engineering station. Weighing 74 pounds and measuring just 17.3-inches wide by 21.65-inches deep, the cart has three shelves that can support a combined weight of 77 pounds of equipment.



CIRCLE 20 ON FREE INFORMATION CARD

The top shelf is tiltable, and has trigger-action tilt locks and probe holders.

The 997 oscilloscope cart also features swivel wheel locks, a rugged 14-gauge steel frame, and seam welding for extra rigidity and strength.

The model 997 scope cart costs \$795.00.—**Kikusui International Corporation**, 19601 Mariner Avenue, Torrance, CA 90503. R-E

Video Training Tape "VCR Mechanical Problem Diagnosis"

NEW instructional videotape from TENTEL shows how to take the guessing out of diagnosing VCR mechanical problems. Over sixty minutes that describes 28 different mechanical checks that should be made to a VHS tape transport. It demonstrates the use of the TENTELOMETER® Tape Tension Gauge, Dial Torque Gauge, TSH 6-Function Reference Plane Gauge, HPG Head Wear Gauge and the manufacturer alternatives where applicable.

This video explains elevator latching problems, tape guide height, spindle height, motor and brake torque, tension servo performance, eccentricity and more! This tape also explores the mathematics of and theory behind why these checks are so important. If you fix VCR's or plan to fix VCR's, this tape is a must for understanding VCR mechanisms. Possibly the best value in VCR repair today!

Order Your Copy!

(800)538-6894

(408)379-1881

(In California)

Introductory Price

\$24⁹⁵ Complete
With
Shipping

VISA - Mastercard - C.O.D.

TENTEL®

1506 Dell Avenue Campbell, CA 95008

CIRCLE 181 ON FREE INFORMATION CARD

CONNECTION PROTECTION

SWITCHES & RELAYS
EDGE CONNECTORS
PLUGS & SOCKETS
POTENTIOMETERS
CONNECTING CABLES
TERMINAL STRIPS
GOLD PLATED CONNECTORS
BATTERY CONTACTS



CRAMOLIN®

Even the finest equipment in the world cannot guarantee noise-free operation. One "dirty" connection anywhere in the electrical path can cause unwanted noise or signal loss.

"MORE THAN A CONTACT CLEANER"

CRAMOLIN® is a fast-acting, anti-oxidizing lubricant that cleans and preserves all metal surfaces, including gold.

When applied to metal contacts and connectors, **CRAMOLIN®** removes resistive oxides as it forms a protective molecular layer that adheres to the metal surfaces and maintains maximum electrical conductivity.

CRAMOLIN® - USED BY THOSE WHO DEMAND THE BEST:

| | | | |
|-----------------|-----------------|-----------|-------------|
| Bell & Howell | Hewlett Packard | MCI(Sony) | Nakamichi |
| Boeing | John Fluke Mfg. | Motorola | RCA |
| Capitol Records | McIntosh Labs | NASA | Switchcraft |

SINCE 1956

CAIG LABORATORIES INC

1175-O Industrial Ave., (P.O. Box J) - Escondido, CA 92025-0051 U.S.A. • (619) 743-7143

CIRCLE 50 ON FREE INFORMATION CARD

EXPAND YOUR CAREER HORIZONS...

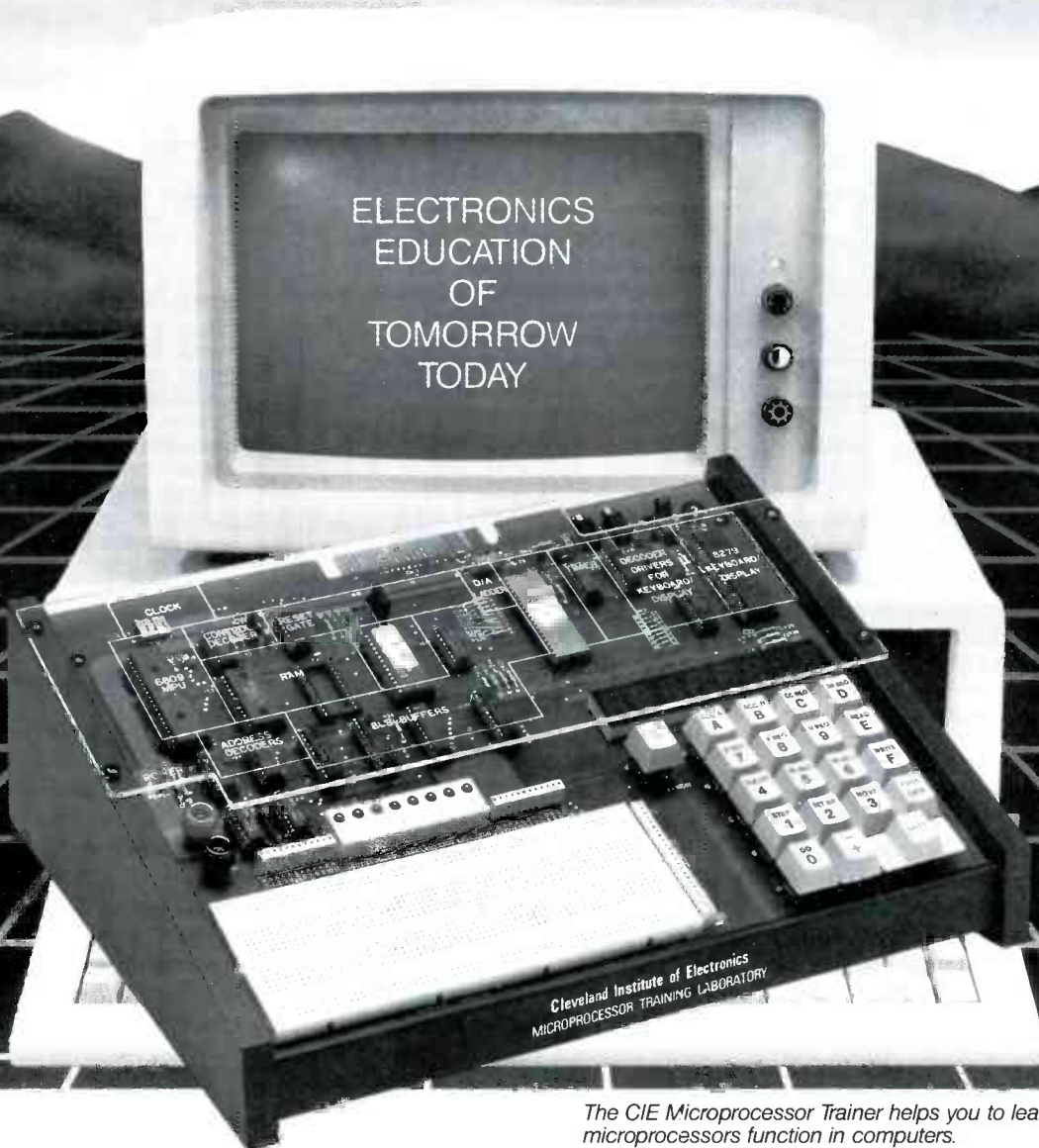

The CIE Microprocessor Trainer helps you to learn how circuits with microprocessors function in computers.

START WITH CIE.

Microprocessor Technology. Satellite Communications. Robotics. Wherever you want to go in electronics... start first with CIE.

Why CIE? Because we're the leader in teaching electronics through independent study. Consider this. We teach over 25,000 students from all over the United States and in over 70 foreign countries. And we've been doing it for over 50 years, helping thousands of men and women get started in electronics careers.

We offer flexible training to meet your needs. You can start at the beginner level or, if you already know something about electronics, you may want to start at a higher level. But wherever you start, you can go as far as you like. You can even earn your Associate in Applied Science Degree in Electronics.

Let us get you started today. Just call toll-free **1-800-321-2155** (in Ohio, 1-800-362-2105) or mail in

CIRCLE 60 ON FREE INFORMATION CARD

the handy reply coupon or card below to:
Cleveland Institute of Electronics,
1776 East 17th Street, Cleveland, Ohio 44114.

CIE World Headquarters

ARE-124

Cleveland Institute of Electronics, Inc.
1776 East 17th Street • Cleveland, Ohio 44114

Please send your independent study catalog. For your convenience, CIE will try to have a representative contact you — there is no obligation.

Print Name _____

Address _____ Apt. _____

City _____ State _____ Zip _____

Age _____ Area Code/Phone No. _____

Check box for G.I. Bill bulletin on Educational Benefits

Veteran Active Duty **MAIL TODAY!**

Just call toll-free **1-800-321-2155** (in Ohio, 1-800-362-2105)

R-E Engineering Admart

Rates: Ads are 2 1/4" x 2 7/8". One insertion \$900. Six insertions \$875. each. Twelve insertions \$845. each. Closing date same as regular rate card. Send order with remittance to Engineering Admart, Radio Electronics Magazine, 500-B Bi-County Blvd., Farmingdale, NY 11735. Direct telephone inquiries to Arline Fishman, area code-516-293-3000. Only 100% Engineering ads are accepted for this Admart.

Surface Mount Chip Component Prototyping Kits—

Only \$49.95

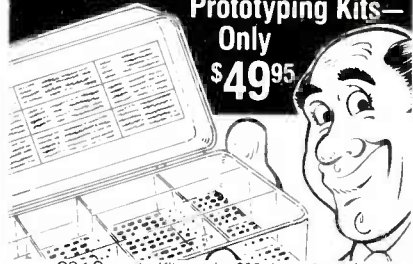

CC-1 Capacitor Kit contains 365 pieces, 5 ea. of every 10% value from 1pf to 33µf. CR-1 Resistor Kit contains 1540 pieces, 10 ea. of every 5% value from 10Ω to 10 megΩ. Sizes are 0805 and 1206. Each kit is ONLY \$49.95 and available for Immediate One Day Delivery!

Order by toll-free phone, FAX, or mail. We accept VISA, MC, AMEX, COD, or Pre-paid orders. Company P.O.'s accepted with approved credit. Call for free detailed brochure.

COMMUNICATIONS SPECIALISTS, INC.
426 West Taft Ave. · Orange, CA 92665-4296
Local (714) 998-3021 · FAX (714) 974-3420

Entire USA 1-800-854-0547

CIRCLE 179 ON FREE INFORMATION CARD

FCC LICENSE PREPARATION

The FCC has revised and updated the commercial license exam. The NEW EXAM covers updated marine and aviation rules and regulations, transistor and digital circuitry. THE GENERAL RADIOTELEPHONE OPERATOR LICENSE - STUDY GUIDE contains vital information. VIDEO SEMINAR KITS ARE NOW AVAILABLE.

WPT PUBLICATION
979 Young Street, Suite A
Woodburn, Oregon 97071
Phone (503) 981-5159

CIRCLE 180 ON FREE INFORMATION CARD

MIDI PROJECTS

MIDI Projects



BP182—MIDI interfacing enables any so equipped instruments, regardless of the manufacturer, to be easily connected together and used as a system with easy computer control of these music systems. Combine a computer and some MIDI instruments and you can have what is virtually a programmable orchestra. To get your copy send \$6.95 plus \$1.25 for shipping in the U.S. to Electronic Technology Today Inc., P.O. Box 240, Massapequa Park, NY 11762-0240.

EQUIPMENTS REPORTS

continued from page 17

FOUR DRIVE SELECT switches let you test drives without changing their configurations. A HEAD LOAD switch loads the head, bringing it into contact with the disk surface, while a HEAD SELECT control lets you choose which head (on two-head drives) is controlled. The ENABLE switch is used to turn on drive motors on some drives.

Eight TRACK ADDRESS SELECT switches and their associated LED's

select and indicate the track where the head is. They can be used in combination with other controls. For example, the STEP control lets you move the head at one of two speeds, to the track selected by them. The SEEK TRK 0 switch can be used to step indefinitely back and forth between track 0 and the track selected by the TRACK ADDRESS SELECT switches.

Other switches include DATA, which allows one of two patterns to be written to disk, and SPEED, which is used to select the proper

rotational speed. The manual contains various troubleshooting charts and operational flow charts to speed the learning process.

The Lynx 470 is packaged in an extremely rugged 16-gauge two-piece steel cabinet that folds to a compact 8 1/2 x 6 3/4 x 2 inches. It weighs about 4 1/4 pounds.

At \$1400, the Lynx 470 disk drive alignment tester should be attractive to anyone who routinely services computers and wants to cut down on the time and expense of drive servicing. **R-E**

EQUIPMENT REPORTS

continued from page 17

is selected. If DNR is desired, the signals pass through National Semiconductor's LM1894 DNR IC before being output through the unity-gain amp.

The signals for the rear-channel amplifier are fed through various amplifier networks, the DNR circuit if desired, and a 1024-stage bucket-brigade device that is used for adding a time delay.

For proper surround-sound reproduction, the rear speakers should be as far behind you as the front speakers are in front of you. Unless you have a huge living room, your speaker placement would be compromised without some sort of time delay to give the

illusion that your rear speakers are farther behind you than they really are. Naturally, the farther your rear speakers were placed behind your listening position, the longer the rear-channel sounds take to reach your ears, and the less you would need the time delay.

The surround channel time delay can be adjusted between 5 and 50 milliseconds with the DELAY TIME control, one of three front-panel potentiometers. Another control, SURROUND EFFECT, varies the strength of the effect of the surround delay, and the level of the rear channel is controlled by the SURROUND LEVEL control.

In our tests, the SM-333 worked as it was designed. However, we disagree with the design in one respect. The surround channel al-

ways has an output, even if the source is meant to be heard strictly from the front. We can think of some instances where that might be desirable. But since that is not the way surround sound is meant to be decoded, it should be *selectable*. We found the DNR circuit to be very effective in removing audio noise from video tapes. It can get addicting very quickly.

The SM-333 is available in both kit and assembled form for \$62 and \$83 respectively. Even though the instructions are not very good, the kit should pose little problem for moderately experienced hobbyists. Despite what we feel to be inaccurate surround decoding, the decoder is an excellent, low-cost way to get acquainted with surround sound. **R-E**

SELECT 5 BOOKS for only \$3.95

(values to \$134.70)
and get a **FREE Gift!**

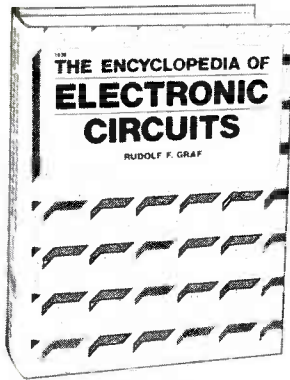
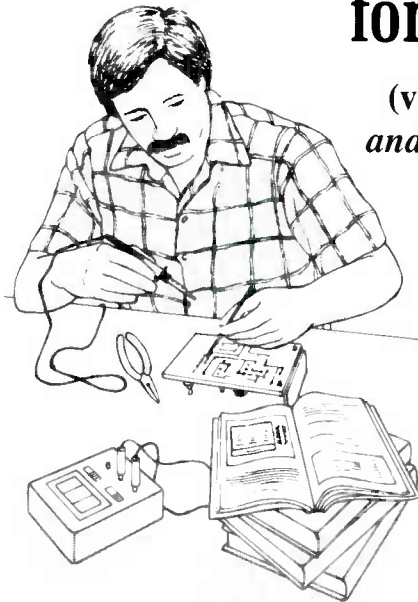

1938 \$60.00
Counts as 3



2613 \$24.95



1199P \$18.95



1625P \$16.95



2947 \$21.95

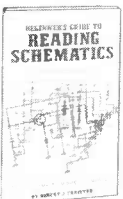

1536P \$9.95

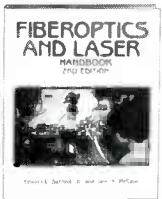

2981 \$24.95

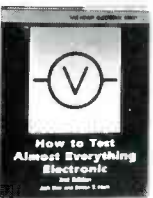

2925 \$16.95



2707 \$26.95
Counts as 2



2992 \$24.95



1367P \$18.95

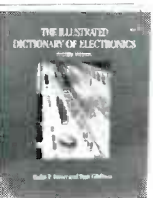

2900 \$36.95
Counts as 2



2885 \$16.95

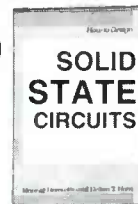

2975 \$24.95

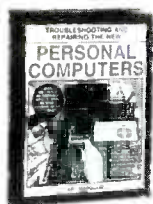

2809 \$26.95
Counts as 2



1599P \$17.95

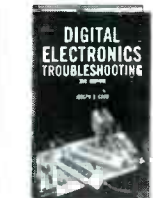

2750P \$17.95

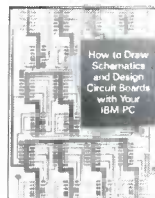

3034 \$19.95

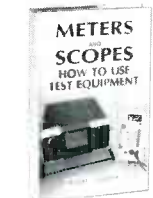

2826P \$15.95

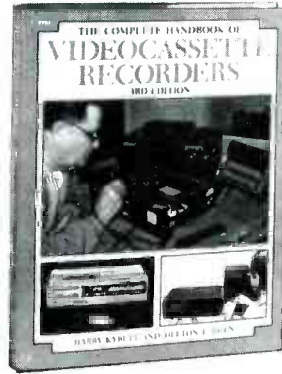

2731P \$14.95

Electronics projects . . . ideas . . . the latest technology
all at up to 50% off publishers' prices!

Membership Benefits • Big Savings. In addition to this introductory offer, you keep saving substantially with members' prices of up to 50% off the publishers' prices. • **Eonus Books.** Starting immediately, you will be eligible for our Bonus Book Plan, with savings of up to 80% off publishers' prices. • **Club News Bulletins.** 14 times per year you will receive the Book Club News, describing all the current selections—mains, alternates, extras—plus bonus offers and special sales, with scores of titles to choose from. • **Automatic Order.** If you want the Main Selection, do nothing and it will be sent to you automatically. If you prefer another selection, or no book at all, simply indicate your choice on the reply form provided. As a member, you agree to purchase at least 3 books within the next 12 months and may resign at any time thereafter. • **Ironclad No-Risk Guarantee.** If not satisfied with your books, return them within 10 days without obligation! • **Exceptional Quality.** All books are quality publishers' editions especially selected by our Editorial Board.

©1989 ELECTRONICS BOOK CLUB®, Blue Ridge Summit, PA 17294-0810
All books are hardcover unless number is followed by a "P" for paperback (Publisher's Prices shown).

FREE when you join!

15 Easy Electronic Projects From Delton T. Horn
Projects you can build—some unique, some old favorites—from the author's vast treasury of electronics know-how.



ELECTRONICS BOOK CLUB®
Blue Ridge Summit, PA 17294-0810

Please accept my membership in the Electronics Book Club® and send the 5 volumes listed below, plus my FREE copy of *Delton T. Horn's All-Time Favorite Electronic Projects* (3105P), billing me \$3.95 plus shipping and handling charges. If not satisfied, I may return the books within ten days without obligation and have my membership cancelled. I agree to purchase at least 3 books at regular Club prices (plus shipping and handling) during the next 12 months and may resign any time thereafter.

| | | | | |
|--|--|--|--|--|
| | | | | |
| | | | | |

Name _____
Address _____
City _____
State _____ Zip _____ Phone _____
Signature _____

Valid for new members only. Foreign applicants will receive special ordering instructions. Canada must remit in U.S. currency. This order subject to acceptance by the Electronics Book Club®. RE 589



2995 \$25.95

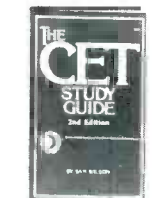

2941 \$21.95



2883 \$25.95

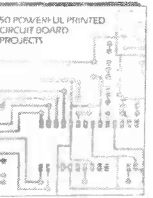

2972 \$23.95



1532P \$14.95



3031 \$24.95

CIRCLE 184 ON FREE INFORMATION CARD

WITH CIE, THE WORLD OF ELECTRONICS CAN BE YOUR WORLD, TOO.

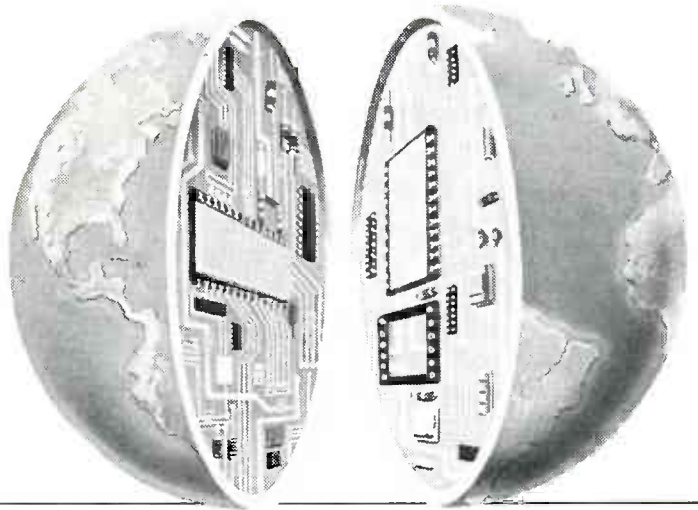

Look at the world as it was 20 years ago and as it is today. Now, try to name another field that's grown faster in those 20 years than electronics. Everywhere you look, you'll find electronics in action. In industry, aerospace, business, medicine, science, government, communications—you name it. And as high technology grows, electronics will grow. Which means few other fields, if any, offer more career opportunities, more job security, more room for advancement—if you have the right skills.

SPECIALISTS NEED SPECIALIZED TRAINING.

It stands to reason that you learn anything best from a specialist, and CIE is the largest independent home study school specializing exclusively in electronics, with a record that speaks for itself. According to a recent survey, 92% of CIE graduates are employed in electronics or a closely related field. When you're investing your time and money, you deserve results like that.

INDEPENDENT STUDY BACKED BY PERSONAL ATTENTION.

We believe in independent study because it puts you in a classroom of one. So you can study where and when you want. At your pace, no somebody else's. And with over 50 years of experience, we've developed proven programs to give you the support

such study demands. Programs that give you the theory you need backed with practical experience using some of the most sophisticated electronics tools available anywhere, including our Microprocessor Training Laboratory with 4K of random access memory. Of course, if you ever have a question or problem, our instructors are only a phone call away.



START WHERE YOU WANT, GO AS FAR AS YOU WANT.

CIE's broad range of entry, intermediate, and advanced level courses in a variety of career areas gives you many options. Start with the Career Course that best suits your talents and interests and go as far as you want—all the way, if you wish, to your Associate in Applied Science Degree in Electronics Engineering Technology. But wherever you start, the time to start is **now**. Simply use the coupon below to send for your FREE CIE catalog and complete package of career information. Or phone us, toll-free, at **1-800-321-2155** (in Ohio, 1-800-523-9109). Don't wait, ask for your free catalog now. After all, there's a whole world of electronics out there waiting for you.

CIE

Cleveland Institute of Electronics, Inc.
1776 East 17th Street, Cleveland, Ohio 44114

Member NHSC
Accredited Member National Home Study Council

CIE **Cleveland Institute of Electronics, Inc.**
1776 East 17th Street, Cleveland, Ohio 44114

ARE-125

YES... I want to learn from the specialists in electronics—CIE. Please send me my FREE CIE school catalog, including details about CIE's Associate Degree program, plus my FREE package of home study information.

Name (print): _____

Address: _____

City: _____ State: _____ Zip: _____

Age: _____ Area Code/Phone No.: _____ / _____

Check box for G.I. Bill bulletin on educational benefits:

Veteran Active Duty

**MAIL
TODAY!**

BUILD THIS

ISDN PROTOTYPING TELEPHONE

DOUG TOUSIGNANT

LOOK ON BUSINESS DESKTOPS AND YOU'LL FIND A personal computer or workstation. And right next to it, there's another business information-processing computer—a telephone.

Remember when a telephone was a few relays, a big mechanical bell, a rotary dial, and a microphone and speaker? Today, office telephones are called station sets; they are computers that also happen to be telephones. They have information displays, keyboards, and so many other features, that a telephone call is no longer just talking—it's digital signal processing.

Introducing the Millcom Prototyping Telephone. With it, you can explore the ways that modern telephone equipment does more than just transmit and receive voices. You'll be experimenting with the fundamentals of Integrated Services Digital Network (ISDN) technology

The prototyping telephone is an electronic, programmable development platform that operates as a TE1, which is an ISDN-compatible piece of telephone equipment. The prototyping telephone makes it easy to experiment with DTMF (Dual-Tone Multi-Frequency) encoding and decoding, call-progress information, audio processing for the microphone and speaker, and also shows how TE1's operate in the ISDN environment. Even if you don't have ISDN service available, you'll be able to develop ISDN-like features, and be ready as soon as ISDN hits your area.

The prototyping telephone that we'll describe is a single board

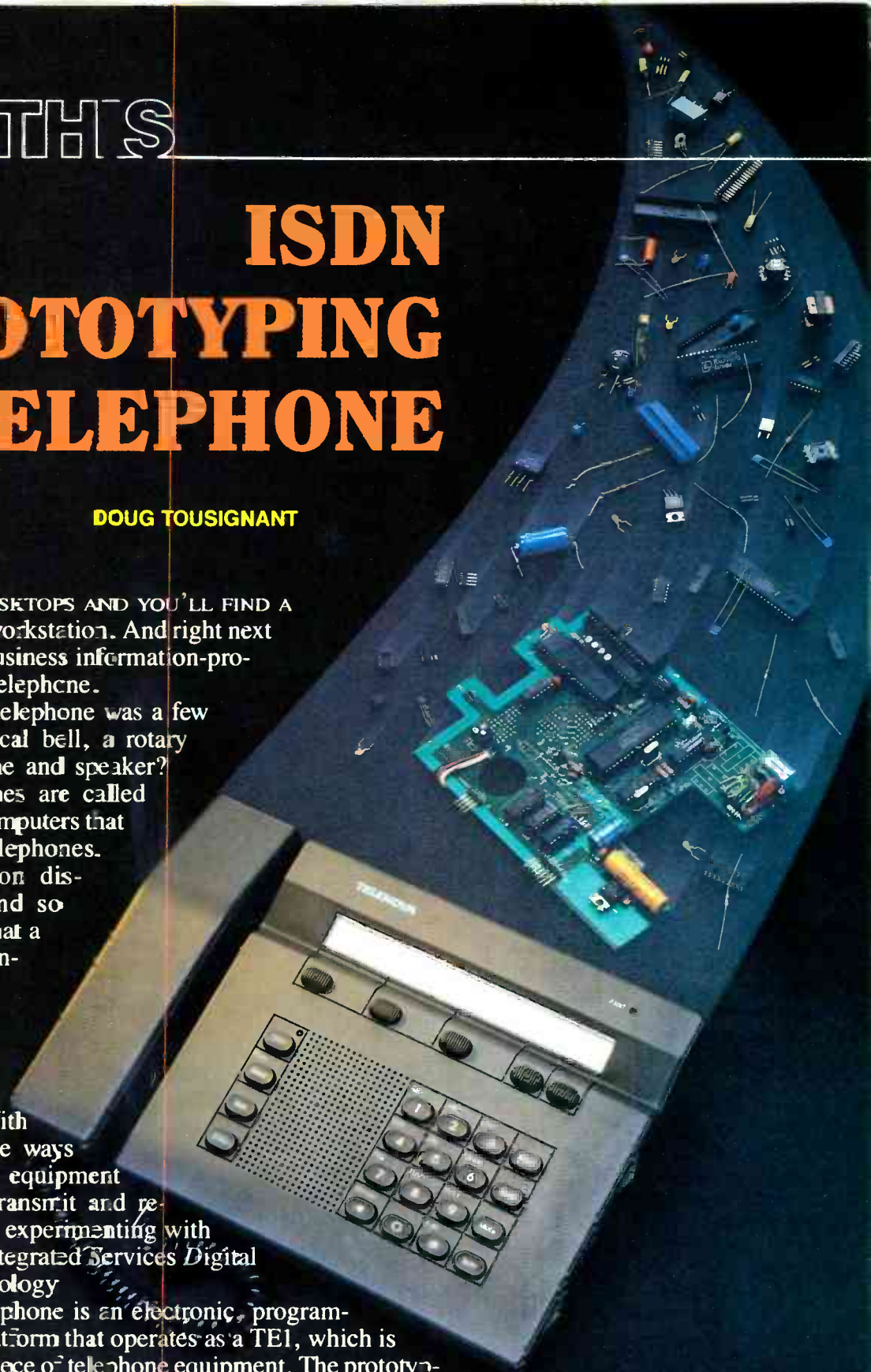

Our prototyping telephone will let you get acquainted with ISDN from the bottom up.

that is designed as an add-on for a Telenova station set. The Telenova station set—which you may have seen on *Miami Vice*, *Moonlighting*, or the movie *Scrooged*—is a telephone that is designed exclusively for use on Telenova and Wang PBX's or PABX's. It features a 2-line by 40-character display, keys for telephone functions, and five "soft keys" whose functions are determined by software running in the phone.

The Telenova station set is controlled by an Intel 8085 microprocessor with 64K of memory. The processor controls the display, the keyboard, and other functions. Installing the prototyping-telephone circuit board and new software in the station set adds several features to it: a serial/parallel interface for connection to a personal computer and a printer, a complete analog telephone on a chip. DTMF encoding and de-

coding, call-progress monitoring, and, of course, the components that make it a TE1.

It is possible to connect the prototyping telephone circuit board directly to a computer and control it through a parallel printer port. In fact, we'll show how that is done next month. Now, however, we'll assume that the kit board will be assembled inside a Telenova station set. The prototyping board connects to the motherboard inside the Telenova station set via a 50-pin connector, and its components are addressable by the station set's 8085. The kit comes with complete assembly instructions, user manual with experiments, and trouble-shooting guide.

There are only three jumpers that have to be installed between the motherboard and the kit board. The kit board mounts perfectly inside the Telenova station set; it can also be

externally mounted and connected to the processor via a ribbon cable.

Why process phone calls?

Whether the prototyping telephone is then connected to tip-and-ring, the Telenova digital switch, or an ISDN interface, the incoming and outgoing telephone functions are all available for processing by the user.

Outbound calls should be processed for a number of reasons. Why should you have to listen to ten rings or perhaps a busy signal, when you can let the computer do that? You can have your PC ring a number every few minutes and report on the number's disposition. You don't even have to pick up the phone if all you want to do is send a FAX or some electronic mail. You can easily find out how much time you spend talking, and how much time you spend listening.

There are many reasons why in-

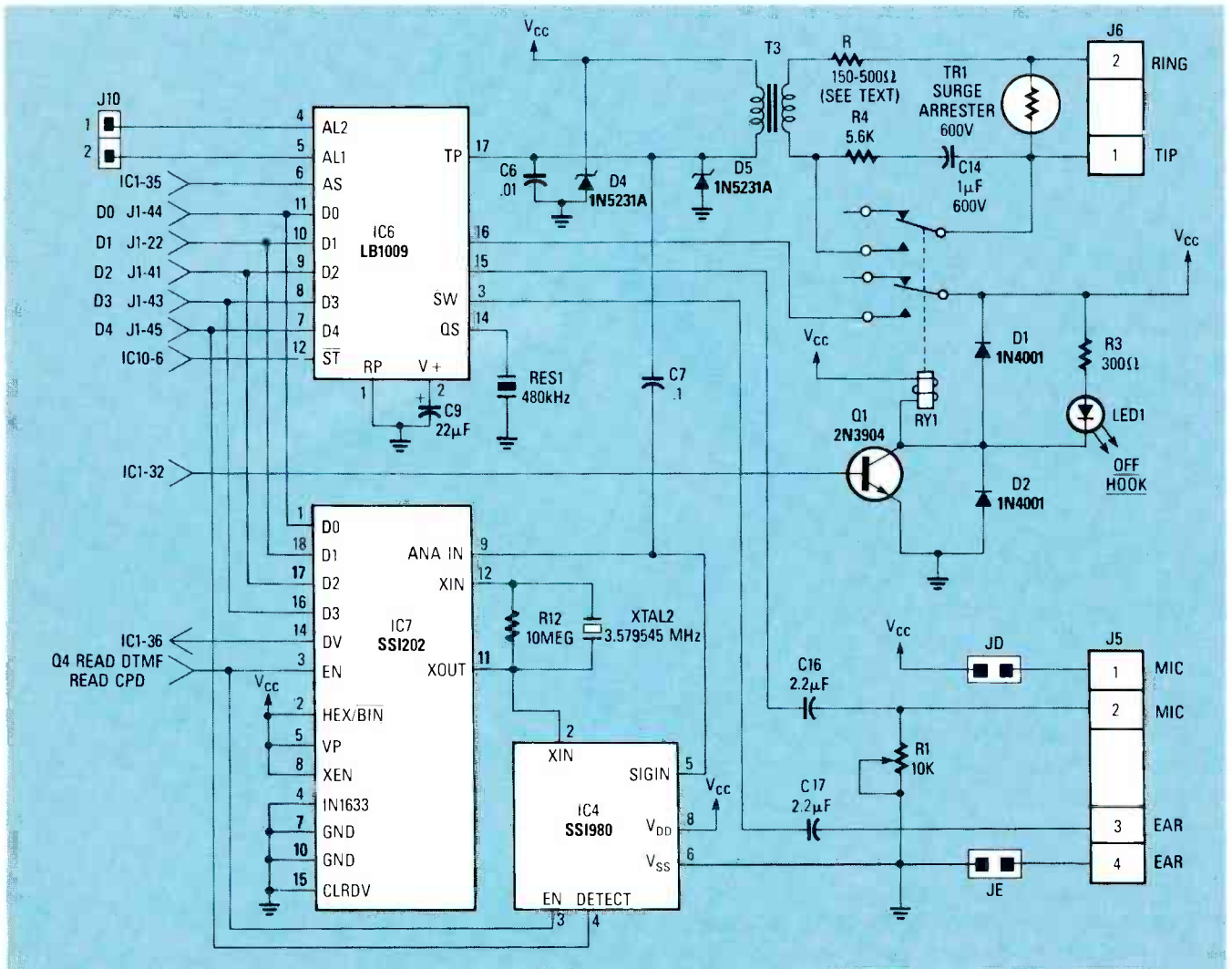

FIG. 1—THE TIP-AND-RING SECTION is the physical interface between the prototyping telephone and an actual phone line. The LB1009AE provides a complete analog telephone on a chip.

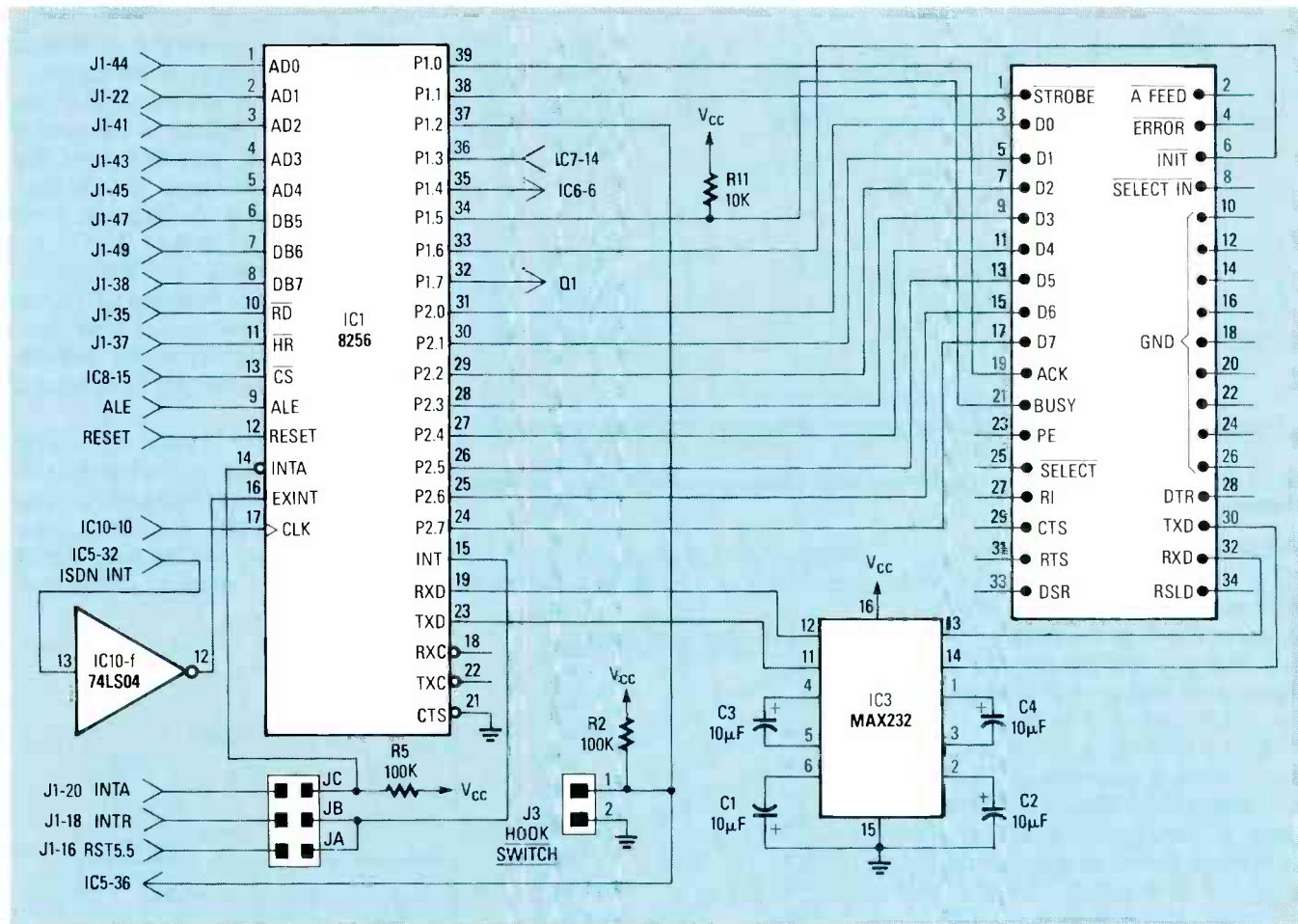

FIG. 2—THE MAX232 IS USED to transmit and receive RS-232-C signals. An 8256 MUART provides serial/parallel communications with the outside world.

bound calls should be processed, too. Before being interrupted by a ringing telephone, why not have the computer first tell you who's calling? Many PBX systems have a "do not disturb" mode. With the prototyping telephone and a computer, you can create your own "do not disturb" mode. You'll be able to tell the machine what incoming numbers to put through, and like many voice-mail systems, a caller can communicate with your phone by pressing numbers instead of talking. You can leave the office, come back two hours later, and look at a list of inbound calls you missed instead of looking through a batch of while-you-were-out slips. Then you can tag the calls you want to return, sort them, and have the computer make the calls for you. Of course all of these features require software. We'll give examples of features for which the Millcom kit can be programmed, and we'll also post a few on the RE-BBS (516 293-2283) to get you started. But the real fun comes when you develop new applications that were previously impossible.

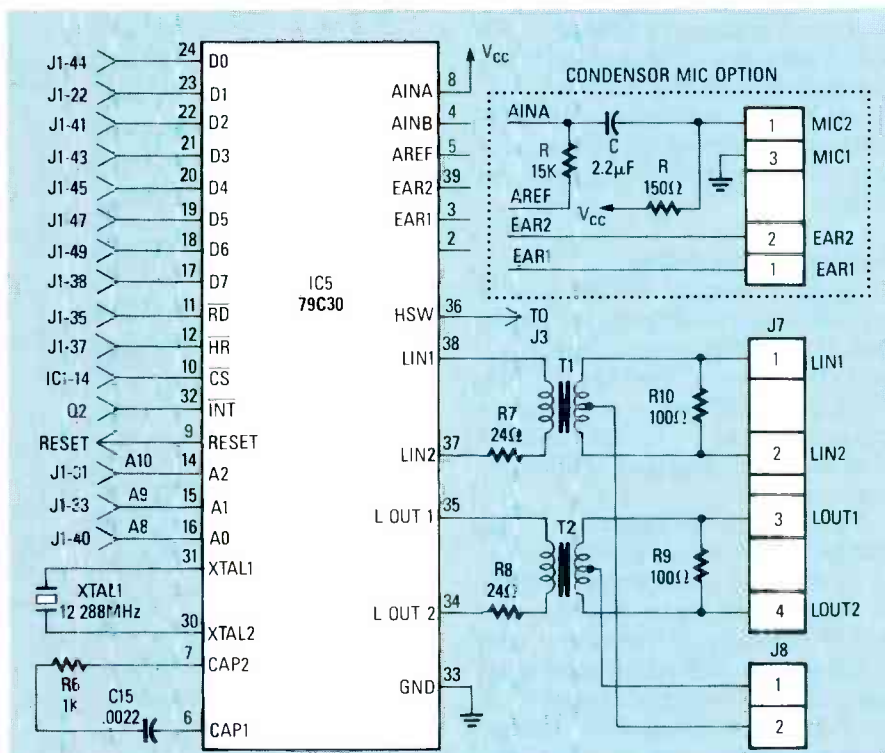

FIG. 3—THE AM79C30 PROVIDES THE TELENOVA telephone with TE1 abilities. It is basically the "ISDN microprocessor," keeping track of all ISDN functions.

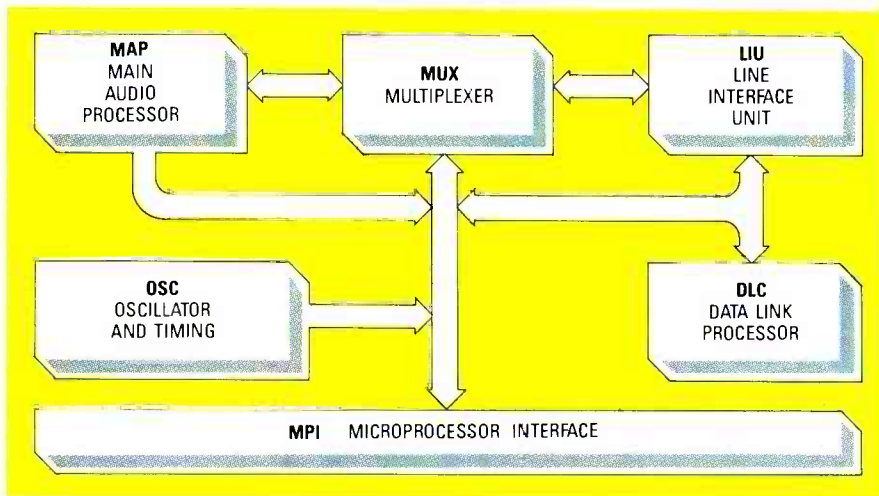

FIG. 4—THE AM79C30A IS DRIVEN BY the 8085 microprocessor in the prototyping telephone.

Circuitry

The tip-and-ring section of the Millcom prototyping telephones, shown in Fig. 1, is the physical interface between the prototyping telephone itself and an actual telephone line. Also contained in Fig. 1 is the AT&T LB1009AE, a 20-pin package that provides a complete analog telephone on a chip. The SSI 202P is an 18-pin IC used to receive DTMF signals (*Touch Tones*) so that they can be processed as numbers. An SSI 980 processes call-progress data, such as busy signals and the ring back (the ring that you hear in the earpiece of your telephone when making a call).

Figure 2 contains an 8256 MUART which provides serial/parallel communications with the outside world. A MAX232 is used to convert the 5-volt serial data inside the phone to 12-volt levels used by RS-232, and vice versa.

Subscriber controller.

Figure 3 contains the device that provides the prototyping telephone with TE1 abilities—that is, it makes it an ISDN device. The AM79C30A digital subscriber controller is basically the “ISDN microprocessor,” keeping track of all ISDN functions.

The block diagram of the AM79C30A is shown in Fig. 4. Driven by the 8085 microprocessor in the prototyping telephone, the AM79C30A digital subscriber controller provides 2B + D channel interface, the “S” reference transceiver, D-channel processing with multiple terminal access, and an audio processor. (If you are unsure of the terminology being used here, don’t

worry—we will discuss it in greater detail later on.) It communicates with

the companion processor via interrupts and is programmed by reading from and writing to internal registers.

The *Line Interface Unit* (LIU) connects the AM79C30A to the outside world ISDN “S” reference point. Remember, “S” reference data is digital. Also, some framing and error checking is done in the LIU.

The Multiplexer section (MUX) transfers the data from the LIU to the main audio-processing section (MAP), the interface to the companion microprocessor (MPI), or a serial port.

In the *Main Audio Processor* (MAP) section, digital-to-analog conversion is done, and tones are generated for DTMF, the alerter, ring-back, dial tone, and the busy signal. There are two attenuation/distortion

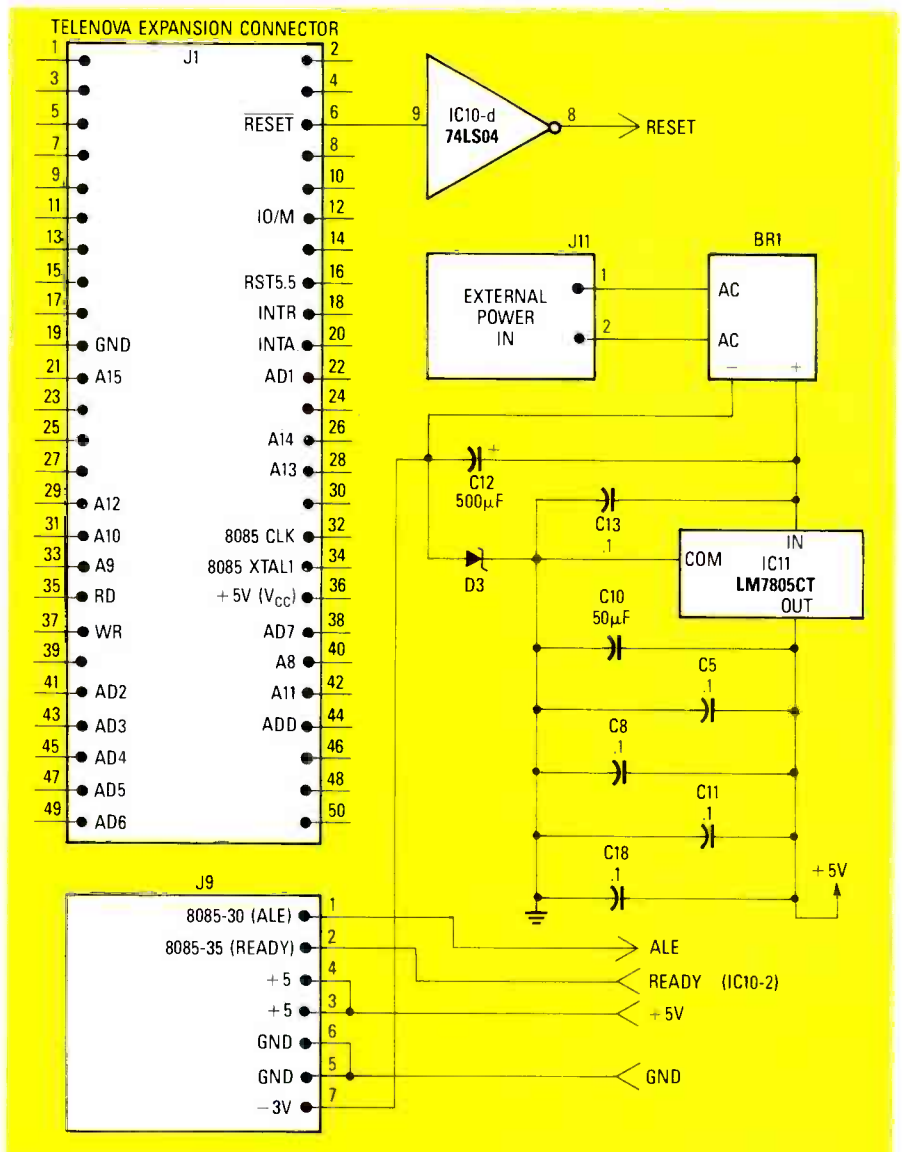

FIG. 5—THE MAJOR DIGITAL SIGNALS from the mother board of the Telenova are brought to the components on the Millcom kit board by J1, and the remaining signals are supplied by J9.

filters, one gain filter in the transmit path, and two gain filters in the receive path, as well as the audio-input ports and the loudspeaker and ear-piece drivers.

The Data Link Controller (DLC) handles the layer-1 and partial layer-2 LAPD (Link Access Protocol for the D-channel) processing. Control packets are assembled and received, and some address recognition takes place in the DLC.

The processes inside the AM79C30A are complex, and *Advanced Micro Devices'* publication 09893 describes them in great detail. However, in a simple fashion, lets follow a bunch of bits to and from the 4-wire ISDN "S" reference point through the AM79C30A for a point-to-point TE1.

Incoming and outgoing bits are grouped into frames of 48 bits. The

I/O PORT DEVICE

| | |
|-----------|-------------------------|
| 00h - 0fh | 8256 MUART |
| 10h - 17h | 79C30A (ISDN DSC) |
| 20h | read DTMF/call progress |
| 30h | write DTMF data |

LIU checks those frames for errors and establishes a synchronization. The LIU determines if the bits from the "S" reference are B-channel data or D-channel data and directs them accordingly. If those bits are D-channel data, the LIU multiplexes the data, which then goes to the DLC. B-channel data would go to the MUX.

In the DLC, more error checking takes place, and rudimentary address recognition is done. D-channel packets are buffered and made available to the companion processor, which further processes the addresses and the packets, decides what to do, then fills

the D-channel transmit buffer and the DLC sends the data back to the LIU and out to the "S" reference.

If the LIU found B-channel data, it would give the data to the MUX. The MUX would forward the data for audio processing in the MAP, information processing in the MPI, or to a serial RAM port. In the MAP, telephone signals such as dial tone and DTMF can be prepared and transmitted, or the alerter can be set off. If the B-channel data is voice, then the MAP filters can be modified to provide different loudness and tone for transmit, receive, and sidetone.

While the B-channel is transmitting and receiving the voice data, the D-channel is still busy checking, signaling, framing, multiplexing, addressing, and assembling packets.

While most of the work is done by the Digital Subscriber Controller, a companion processor like the 8085 in the prototyping-telephone kit has to eventually manage the information to make something happen.

PARTS LIST

All resistors are 1/4-watt, 5%, unless otherwise noted.

R1—10,000 ohms, single-turn potentiometer

R2, R5—100,000 ohms

R3—300 ohms

R4—5600 ohms

R6—1000 ohms

R7, R8—24 ohms

R9, R10—100 ohms

R11—10,000 ohms

R12—10 megohms

Capacitors

C1—C4, C9—22 μ F, 16 volts, tantalum electrolytic

C5, C8, C11, C13, C18—0.1 μ F, ceramic

C6—0.01 μ F, ceramic

C7—1 μ F, 25 volts, tantalum

C10—300 μ F, 6.3 volts, electrolytic

C14—500 μ F, electrolytic

C12—0.1 μ F, 400 volts, ceramic

C15—0.0022 μ F, ceramic

C16, C17—2.2 μ F, 25 volts, tantalum

Semiconductors

IC1—Intel 8256 MUART

IC2—SN74LS74N D flip flop

IC3—Maxim MAX232 or ICL232CPE, RS-232-C TX/RX

IC4—Silicon Systems SSI75T980-CP, call-progress tone detector

IC5—Advanced Micro Devices AM79C30APC, digital subscriber controller

IC6—AT&T LB1009AE, analog-telephone IC

IC7—Silicon Systems SSI75T202-IP, low-power DTMF receiver

IC8—SN74LS138N, decoder/demultiplexer

IC9—SN74LS02N, quad 2-input NOR gate

IC10—SN74LS04N, hex inverter

IC11—LM7805CT, 5-volt regulator

D1, D2—1N4004 rectifier diode

D3—1N5228A, 3.9-volt Zener diode

D4, D5—1N5231A, 5.4-volt Zener diode

TR1—600-volt surge arrester

BR1—MDA101A 3N247 bridge rectifier

LED1—red light-emitting diode

Q1—2N3904 NPN transistor

Other components

J1—EC-pin 0.1-inch center dual row connector

J2—34-pin 0.1-inch center right-angle dual-row connector

J3—J10—Miscellaneous 0.1-inch center right-angle/vertical connector strips.

RES—400-kHz ceramic resonator

RY1—R2-5-C ITT relay

T1, T2—Precision Components "S/T" custom transformers

T3—11 audio-isolation transformer

Miscellaneous: 1-103327-6, VIKSR40FT2R, 103328-3 Amp,

531220-1, MX4-2695, DB95 IDC connector, DB25P IDC connector,

34-pin dual-row 0.1-inch center IDC connector, 34-conductor ribbon cable (6-inch max.),

low-profile IC sockets: 8-pin, 14-pin, 16-pin, 18-pin, 20-pin, 40-pin.

Note: The following are available from Millcom, 3014 Pershall, Saint Louis, MO 63136 (314-524-0804):

Prototyping Telephone Kit board and all parts, \$239. Refurbished Telenova station set with Millcom

PROM BIOS monitor, \$260. PC board, \$39. Flat-rate repair \$100.

I/O and power

As seen in Fig. 5, the major digital signals from the mother board of the Telenova station set are brought to the components on the Millcom kit board by J1, and the remaining signals are supplied by J9. A +5-volt supply is brought out on J9 for external use. A 117-volt AC power adapter is included with the kit, which must be connected to J11. J11 supplies the main power to BR1, which is used for rectification and prevention of polarity reversal. DC power may be supplied directly so that 9 volts appears across the plus and minus terminals of BR1. The signals "ALE" and "READY" must be tapped off the Telenova's 8505 microprocessor, and brought to J9. The -3 volts is also brought out on J9, which must be wired to the display.

For programming, the I/O addresses for the devices on the prototyping telephone are shown in Table 1. Additional access time is required during the access of the AM79C30A's internal registers. Therefore, IC2, shown in Fig. 6, is required to insert one wait state during those accesses.

Construction

A Parts-Placement diagram is shown in Fig. 7, (which, unfortunately, will appear in next month's issue) and the foil patterns for the

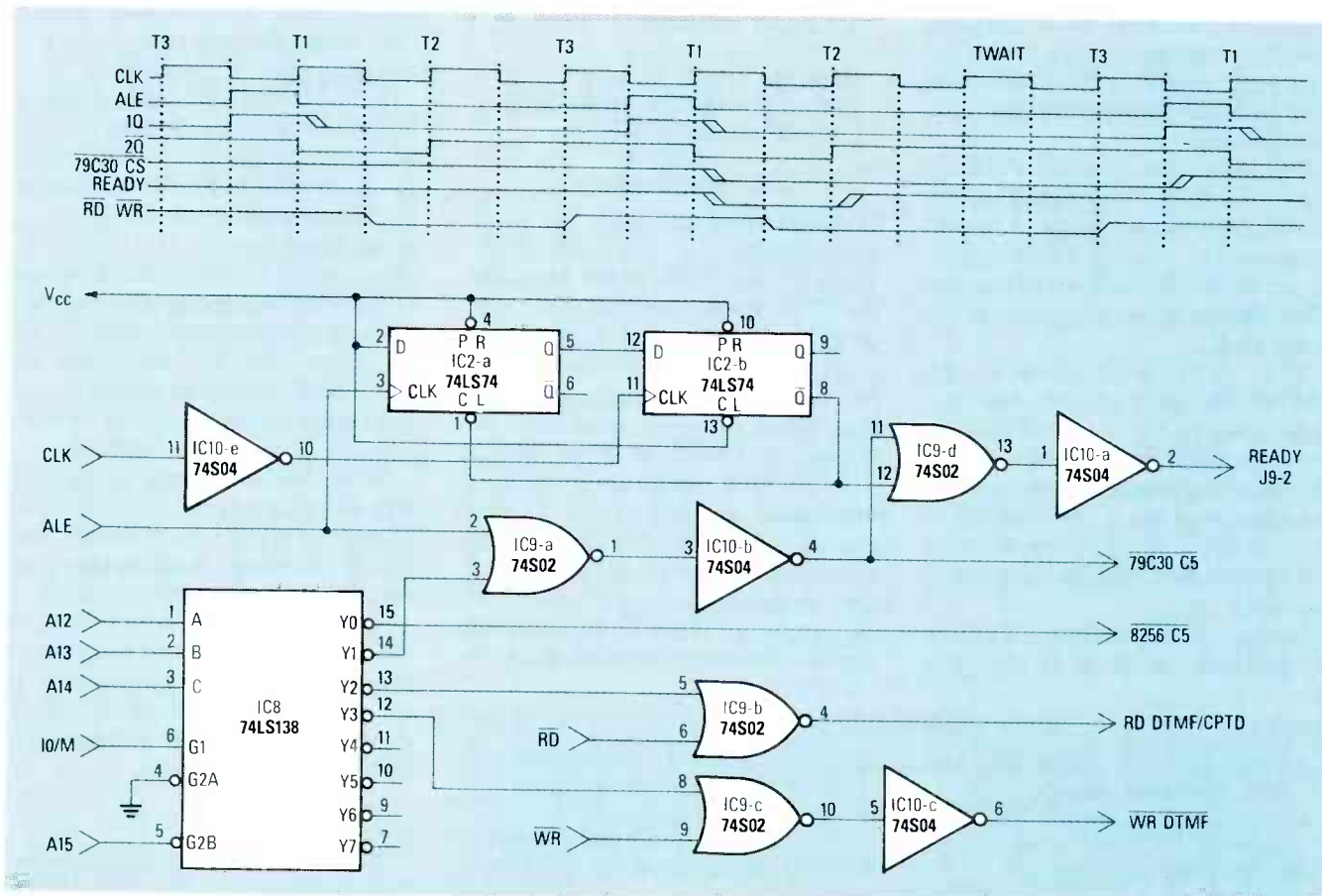

FIG. 6—IC2 PROVIDES THE ADDITIONAL ACCESS TIME required during the access of the AM79C30A's internal registers by inserting one wait state during those accesses.

double-sided PC board are provided in PC Service for those who wish to make their own board. Note that the following instructions apply only if you are installing the Millcom board inside the Telenova station set. Also note that you will need a regular *Touch Tone* telephone and an active phone line for testing, and that we will refer to the *Touch Tone* telephone as a plain old "phone."

To start with, the tip-and-ring interface section must be installed and tested. (Test fit all parts before soldering, and observe component polarity wherever necessary.) Solder R4, C14, RY1, T3, and TR1 to the PC board. Then carefully clip the red and green wires that come from the Telenova's RJ11C connector (tip and ring) close to the PC board, and solder them to their new locations on the Millcom PC board (the tip and ring pads are marked on the upper-right hand side of the Parts-Placement diagram.

Connect a "T" adapter to your existing telephone line so that the prototyping telephone can be connected in parallel. Pick up the handset of the phone, and while listening to the dial tone, plug the prototyping telephone

into the T-adapter. You should hear no distinct change in the dial tone's volume because the 600-ohm bridge has not yet been installed across the line. Troubleshooting is required if the dial tone is lost completely.

Solder Q1, D1, D2, LED1, and R3 to the PC board. Using an ohmmeter, check the resistance between the +5-volt trace and ground. Reverse the leads and repeat. If either reading is less than 1 megohm, troubleshooting is required.

Solder in IC11, D1, C10-C13, BR1, and J11. Check for at least 10 kilohms between the +5-volt trace and ground. Apply +9-volts DC to J11 and check for a regulated +5-volts DC and -3-volts DC. (A 9-volt battery can be used for this test.) Wire a temporary hookswitch; a switch in series with a 1K resistor. Apply +5 volts to the base of Q1; the relay should energize and the offhook LED should light. Repeat the test with the prototyping telephone connected in parallel (plugged into the "T" adapter). Listen for a dial tone on the regular phone, and then force the prototyping telephone offhook again. The volume of the dial tone should

decrease slightly as the relay is energized, and the LED should be on. No unusual sounds should be present on the phone. Break the dial tone by dialing any digit, and, again, listen for any unusual noise. Cycle the relay several times while listening for any noise on the phone. Troubleshooting is required if any noise is heard.

If everything's alright so far, dial your local time-and-temperature number on the phone and note the quality of the reception. Your configuration may require a 150- to 500-ohm series resistor, R, shown in Fig. 1. (If you can't break dial tone, troubleshooting is required.) If you have another *Touch Tone* phone around, repeat the test using that phone. Leave the prototyping telephone connected to the "T" adapter, off hook.

If the audio is acceptable, hang up the phone, wait 5 seconds, and then pick it up again and listen. If the time-and-temperature recording is still audible, the 600-ohm transformer (T3) is properly bridging tip and ring. Disconnect the prototyping telephone from the "T" adapter.

Next month, we'll present the parts-placement diagram, finish construction, and get on to exploring applications for ISDN. R-E

BUILD THIS

REMOTE CONTROL

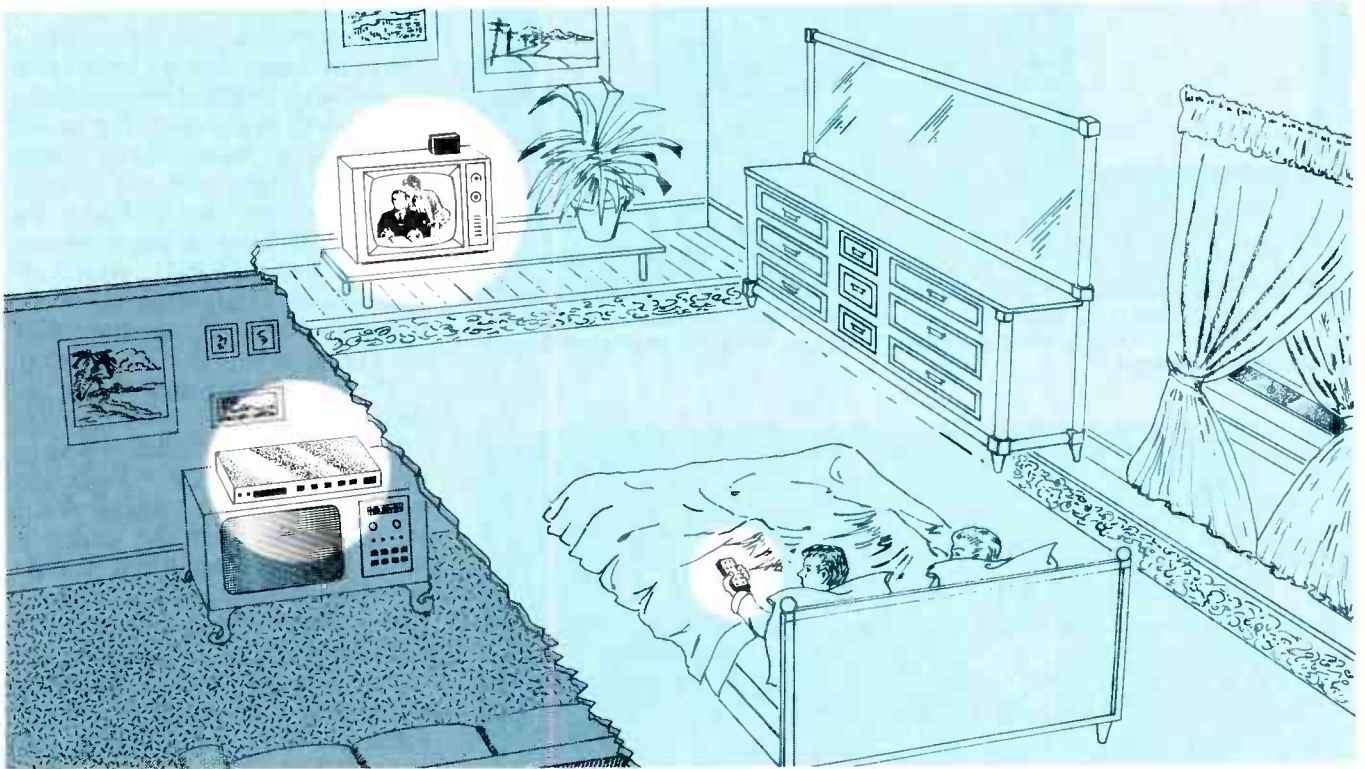

EXTENDER

Control your VCR and watch video tapes from any room in your home with our VCR extender!

ROBERT A. HEIL

WHILE THE NUMBER OF FAMILIES THAT have two VCR's in their home is steadily increasing, owning two VCR's is still considered an expensive luxury for most. But now you can get the benefits of having two VCR's for a fraction of the cost with our VCR extender. Our easy-to-build device will let you watch your VCR from *any* room in your home and still maintain full remote-control capabilities. And the extender is not limited only to VCR's—it will relay *any* IR-transmitted signal. So even if you have an old manually controlled TV in your bedroom, you'll be able to use all the remote-control features of the VCR in your living room!

The extender mounts next to your TV set and can be operated via your

IR remote control from a distance of 20–30 feet depending on ambient light conditions. The unit uses inexpensive, easy-to-get parts, and does not require RFI or IR shielding. Also, several extenders can be connected in parallel, so that you can extend your VCR to as many locations as you like.

Using the extender unit, remote-control signals can be sent to the VCR via the existing coaxial cable (if you have cable television), as shown in Fig. 1, or by using ordinary two-conductor speaker wire or zip cord. The latter will eliminate the need for the two additional filters that are required for the coaxial-cable system but, of course, will require two lines—one for the out-going IR signals, and a second for the returning video or RF.

Circuitry

Refer to the schematic in Fig. 2 for the description of the basic circuit. A signal from an IR remote control enters phototransistor Q1, where it is converted from IR radiation to a frequency pulse and then passed to decoupling-capacitor C1. Resistor R1 keeps Q1 from saturating too quickly from visible light. Because the IR signals from a remote control are not that strong, Q1 is kept constantly conducting, via IR-LED2, which was added to increase the range during extreme low-light conditions. IR-LED2 is positioned directly behind Q1 and aimed at the base, where it emits a small amount of IR radiation, ensuring that Q1 will continue to conduct without IR or visible light.

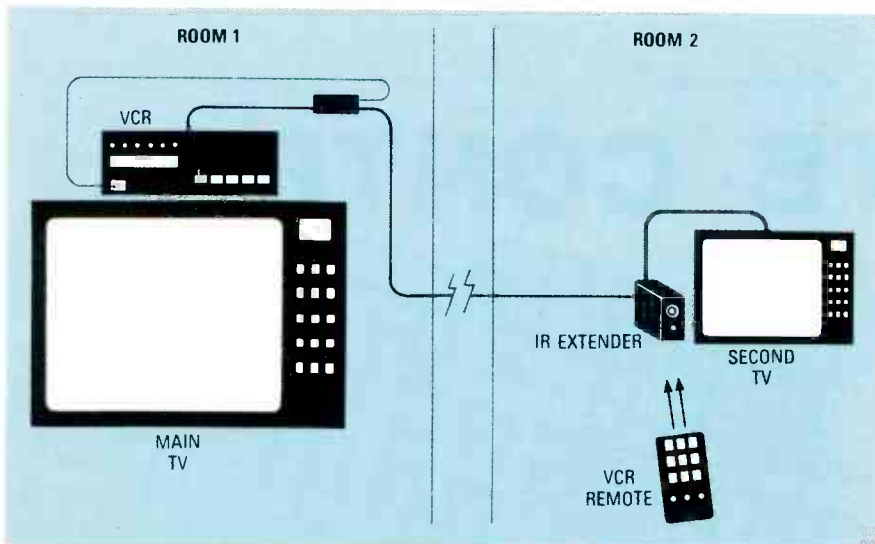

FIG. 1—YOU CAN CONTROL YOUR VCR from any TV set with an extender unit. Signals can be sent to the VCR via the existing coaxial cable or by using ordinary two-conductor speaker wire or zip cord.

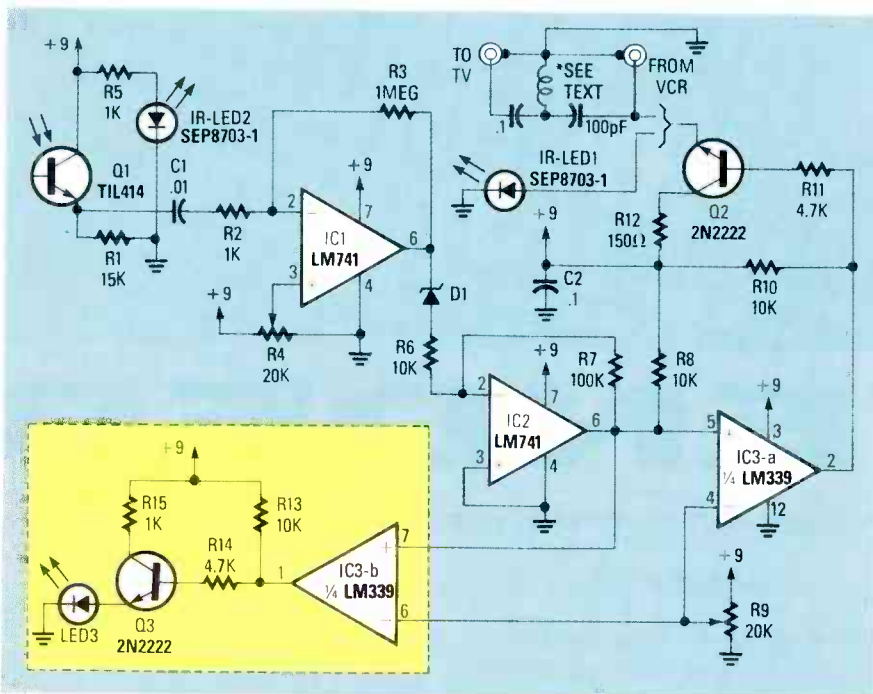

FIG. 2—A SIGNAL FROM AN IR REMOTE CONTROL is converted from IR radiation to a frequency pulse that can be transmitted through coaxial TV cable or any other two-conductor wire to another room, where it's converted back into an IR signal.

The signal from C1 is amplified by a factor of 1000 by IC1, with gain set by R2 and R3. It is then passed to D1, a 5.1-volt Zener diode, which is used as a voltage shifter. The anode stays low until the input voltage at pin 2 of IC1 rises higher than the reference voltage at pin 3, which is set by R4. When that happens, the output of IC1 goes high and avalanches D1, producing a voltage rise at the anode along with the signal. The signal is then passed to IC2 where it is amplified by a factor of 10. Pin 3 of IC2 is tied to

ground. That allows any signal higher than ground to be amplified and sent to pin 5 of IC3 via pull-up resistor R8. IC3 is a comparator, in which the output goes high when the reference voltage at pin 4 (set via R9) is exceeded by the smallest amount.

IC1 and IC2 are independent 741 op-amps. Separate op-amps were used because IC1 is referenced at pin 3 while IC2 is tied to the ground rail at pin 3. Dual or quad op-amps share a common bias network and power-supply leads—that produces noise at the

reference point, so very small signals could not be detected. But by using two independent op-amps, the noise level is reduced and the circuit sensitivity is increased.

The output of IC3 (pin 2) is pulled up by R10 and sent through R11 to the base of Q2, which then passes the signal to IR-LED1 at the VCR by one of two methods. The first method passes the signal directly to IR-LED1 via a suitable length of two-conductor speaker wire or zip cord. The second method passes the signal, via a high-pass filter, right onto the existing coaxial TV cable, to IR-LED1 at the other end. R12 sets the maximum current through IR-LED1, which retransmits the IR signal to the receiving unit's (the VCR, stereo receiver, etc.) IR window.

The components enclosed in the dashed lines in Fig. 2 are optional. That circuit causes an LED to flash on and off rapidly when the IR-extender circuit is activated by a signal from an IR remote control. The circuit is useful in that LED3 will only flash if a signal is being received from a remote control—that way you know if the IR signal is reaching the extender. The circuit works as follows: When the signal from pin 6 of IC2 exceeds the reference voltage set by R9, the output of IC3 causes Q3 to conduct, driving LED3. That can be either a red or green non-IR LED, and R15 sets its current (brightness level).

Construction

A foil pattern is provided in PC Service, and is available separately. (See Parts List.) If you wish to hard-wire the circuit, place the external components as close together as possible to keep stray capacitance to a minimum.

The Parts-Placement diagram is shown in Fig. 3. Be sure that pin 1 on all three IC's faces Q1, and mount Q1 with enough lead length (approximately 3/4-inch) so that it will be able to protrude through a hole in the project box. The flat side of Q1 (the collector) is connected to +9-volts DC. Mount IR-LED2 so that it can be positioned directly behind Q1 (that way it can emit a small amount of IR into the base of Q1 during low-light conditions), as shown in Fig. 4. The flat sides (the cathode) of D1, D2, and D3 are attached to ground.

If you are going to use the existing coaxial cable in your home to transmit

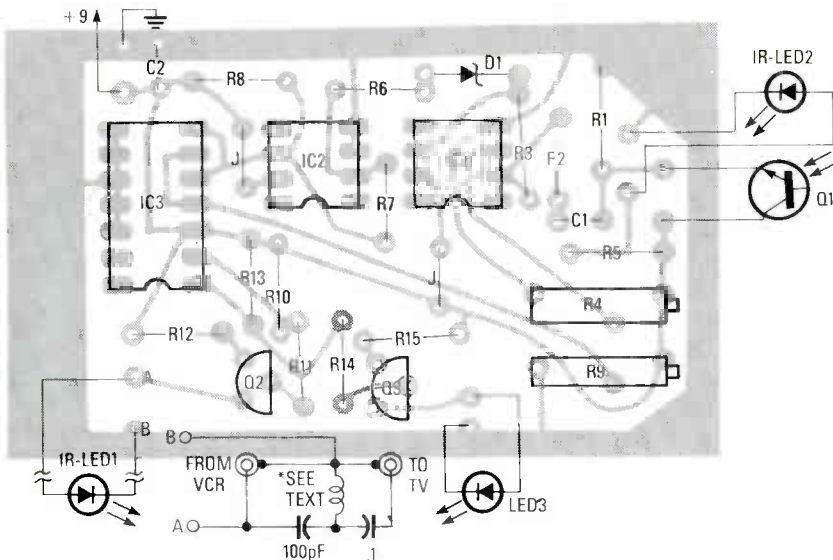

FIG. 3—PARTS-PLACEMENT DIAGRAM. Mount Q1 so that it can protrude through the project box. Either IR-LED1 or the filter circuit attaches to pads A and B.

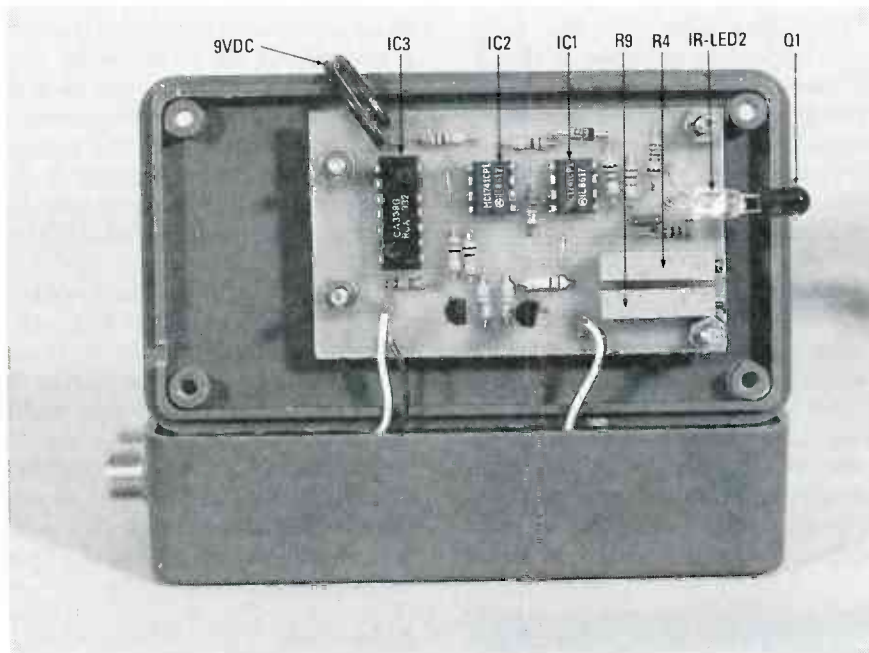

FIG. 4—MOUNT IR-LED2 so that it can be positioned directly behind Q1 as shown. That way it can emit a small amount of IR into the base of Q1 during low-light conditions.

the signals, then two filters are required to decouple the DC voltage and to attenuate the transmitted signal. That keeps the TV tuner or VCR from receiving any harmful DC voltages. The only consequence of doing it that way is that there is an interchanging between the control signal and the video signal that takes place in the coaxial cable when the extender is activated; that results in a small amount of interference that is visible on the TV screen when a command is being sent.

Both filters must be installed be-

tween the last output stage and the tuner of your second TV, as shown in Fig. 5. (If you have an amplifier to boost your VCR output, then the amplifier becomes the last output stage.)

The first filter, located after the last output stage, can be constructed in two ways: The first way—and also the easiest—is to purchase a Radio Shack high-pass filter (PN 15-579). Remove the rubber gromet and slide back the case, as shown in Fig. 6. Take a 4- to 5-foot length of small-gauge two-conductor speaker wire or zip cord, and scrape away enough potting material

PARTS LIST

All resistors 1/4-watt, 5%.

- R1—15,000 ohms
- R2, R5, R15—1000 ohms
- R3—1 megohm
- R4, R9—20,000 ohms, 20-turn potentiometer
- R6, R8, R10, R13—10,000 ohms
- R7—100,000 ohms
- R11, R14—4700 ohms
- R12—150 ohms

Capacitors

- C1—0.01 μ F, disc capacitor
- C2—0.1 μ F, disc capacitor

Semiconductors

- IR-LED1, IR-LED2—SEP 8703-1, infra-red light-emitting diode
- LED3—light-emitting diode, red or green
- Q1—TIL 414 phototransistor
- Q2, Q3—2N2222, NPN transistor
- D1—5.1-volt Zener diode
- IC1, IC2—LM741 op amp
- IC3—LM339 comparator

Other components

- T1—120-volts AC/9-volts DC, wall transformer

Miscellaneous: 4-40 hardware, standoffs, tape, speaker wire, etc.

Note: The following two filters are needed only for transmitting through coaxial TV cable (see text).

Parts for the first filter

- 1 0.1- μ F disc capacitor, 1 100-pF disc capacitor, 1 inductor (see text), 1 chassis-mount F connector, 1 cable-mount F connector, a piece of coaxial TV cable, cardboard, 2 washers, copper tape or aluminum foil.

Parts for the second filter

- 1 0.1 μ F disc capacitor, 1 100-pF disc capacitor, 1 inductor (see text), 2 chassis-mount F connectors.

Note: An etched and drilled PC board is available postpaid for \$7.50 in U.S. funds from Fen-Tek, P.O. Box 5012, Babylon, NY 11707-0012. NY residents must add sales tax.

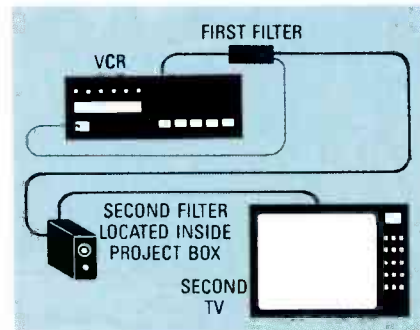

FIG. 5—TWO FILTERS are required if you want to use your current coaxial cable.

at the filter's F connector to attach one wire to the center pin and the other to the ground side (see Fig. 6). Run the

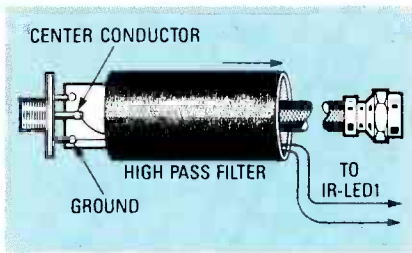

FIG. 6—A RADIO SHACK HIGH-PASS FILTER (PN 15-579) can be used for the first filter if you don't want to make your own.

wire through the case and then slide the case back over the filter. Use RTV silicone to reseal the area where you removed the grommet. Attach IR-LED1 to the other end of the wire. Remember that the wire that you attached to the center pin of the F connector is positive for IR-LED1.

For those true do-it-yourselfers, the other way is shown in Fig. 7. Because solder will not easily adhere to metal plating, file or sand away a small amount of the metal plating on the F connector and washer before soldering. When the filter is finished, wrap a piece of cardboard around it and tape in place. (The cardboard found on a blister pack works well.) The filter should then be wrapped with copper tape or aluminum foil for RF shielding. Make sure that a small piece of copper tape or aluminum foil is in contact with the washers at both ends of the filter to effectively complete the ground shield. You can also build the filter in a small metal case.

The inductors can be obtained in an inductor assortment from Radio Shack (PN 273-1601), or by making your own. If you purchase the induc-

tor assortment, the 1/2-inch enameled wire-wound inductors have a value of 10 μ H. Combined with a 100-pF capacitor, the filter should have a cutoff frequency of about 5 MHz.

If you wind your own inductor, use 22-gauge enameled copper wire, and wind 6 1/2 turns on an 8-32 screw. Remove the screw and coat the outside of the windings with non-conductive RTV silicone. That will keep the windings from deforming during assembly. Scrape and tin both ends of the inductor. The value of the inductor should be approximately 100–200 nH. (It is much more difficult to make a 10- μ H coil by hand, and because a 100- to 200-nH coil will do the job, that's what we'll make.) When that is combined with a 100-pF capacitor, the cutoff frequency should be about 35–50 MHz. The formula used for calculating the cutoff frequency is:

$$F = 1/2\pi\sqrt{LC}$$

The second filter is located inside the extender box as shown in Fig. 8. Be sure to attach the output wires from the PC board to the side that is coming from the other filter and not the one to the TV set. Label the two F connectors as in and out to make installation easier. If you have a TV set that uses a 75- to 300-ohm matching transformer, then the second filter can be omitted. In that case, just solder a bus wire from the center pins of both F connectors, and attach the positive output lead for IR-LED1 to that bus wire. Then bus-wire the grounds together on the F connectors and attach them to the PC board's ground.

If you decide to use the two-wire system, you can install a terminal

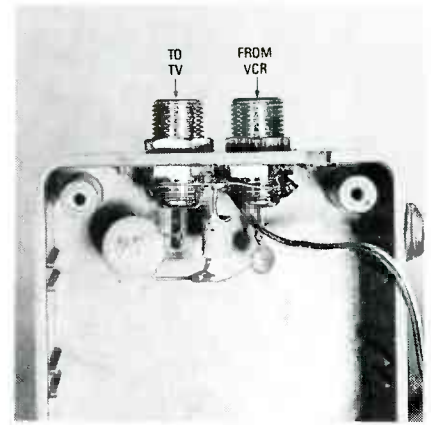

FIG. 8—THE SECOND FILTER, if required, is installed inside the project box across the two F connectors.

block inside the project case, or you can solder the wire directly to the PC board. Just make sure that the grounded lead gets soldered to the cathode of IR-LED1.

The easiest way to mount IR-LED1 on an appliance is to position it so that it covers 1/4 of the IR receiving window on the device that you wish to control. Use a piece of clear tape to secure it to the unit. That way you can still use your remote control in the same room as your receiving unit. Be sure to insulate the legs of IR-LED1 so that they don't short out.

The PC board is installed inside a small plastic project box, and mounted on 1/4-inch stand-offs. If you do not have stand-offs, then 3 nuts on top of each other can be used instead. The hole for Q1 in the front of the project box is not critical. Just be sure that Q1 fits through the opening and slightly protrudes outward. A smaller hole must be drilled for LED3, if you decide to use it.

Calibration

Apply power and make sure that nothing gets too hot. If anything does, then recheck your connections. Then, connect a voltmeter across IR-LED1. Adjust R9 until the output drops to approximately 0.004 volts. Then attach the voltmeter to pin 3 of IC1. Adjust R4 for 4.55 ± 0.05 volts. Remove the test lead and reconnect it across IR-LED1. Again, adjust R9 until the output goes high, and then back off slowly until it drops to approximately 0.004 volts. If you used the optional LED circuit, then there is no need to connect a voltmeter across IR-LED1, because LED3 will light when the output of IR-LED1 is high, and it goes out when it's low. R-E

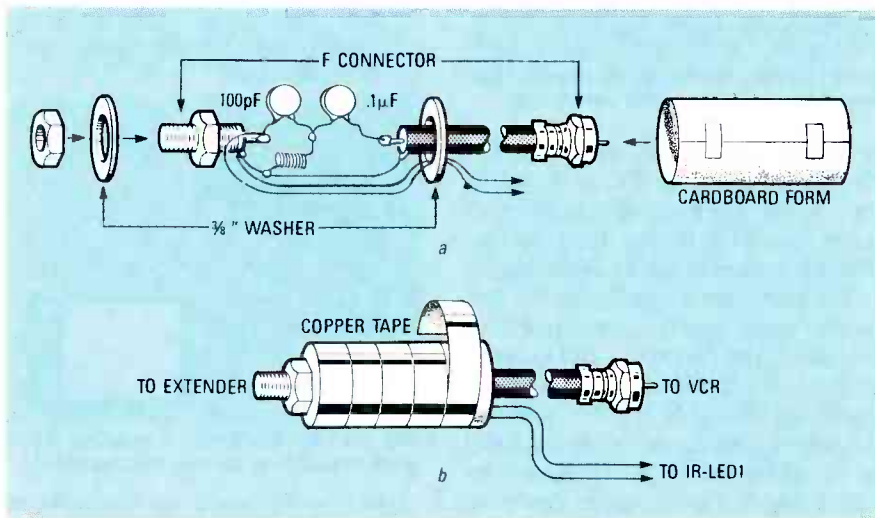

FIG. 7—YOU CAN MAKE YOUR OWN FILTER by first building the assembly shown in (a), and then wrapping it with copper tape or aluminum foil (b).



LEN FELDMAN

All video tapes are created equal...but some video tapes are more equal than others.

WHY IS IT THAT SOME BLANK VIDEO TAPES cost twice or even three times as much as others having the same total recording time? How come some major manufacturers of video tape offer as many as six or eight different "grades" of video recording tape? Does it ever pay to purchase the more expensive tapes offered by those companies? What makes some video tapes "better" than others?

For several years now, *Video Review Magazine*, where the author serves as Technical Editor, has been conducting extensive tape tests, using the facilities known as Advanced Product Evaluation Laboratories, directed by Mr. Frank Barr, who was formerly in charge of the consumer-products testing laboratories of the now defunct CBS Technology Center. Mr. Barr's labs, known by their acronym APEL, have developed a most exacting test system for evaluating the performance of video tape. Industrial, rather than consumer, VCR's are

used in the tests, to ensure that the results will not be limited by the performance of the tape recorder rather than the tape itself. By the way, there's no point in using a tape that provides a video signal-to-noise ratio of, say, 45 dB when your VCR's own signal-to-noise ratio is limited to 42 dB!

The most important parameter

When it comes to video performance, there are four major parameters that generally need to be considered. The first, and most important, is dropouts. A dropout on videotape simply means that a measurable amount of signal is missing from the tape. That can be caused by lack of uniformity of the magnetic-particle dispersion on the surface of the tape, or because the tape, for one reason or another, fails to make intimate contact with the rapidly spinning head-drum of the VCR during recording and/or playback. That type of poor contact, in turn, may be

caused by an actual bump or lump that appears along the surface of the tape or by an overall lack of smoothness.

The visible effect of dropouts is the appearance of a white speck or even a horizontal streak on your TV screen. Many inexperienced viewers attribute such flecks or streaks to a poor signal-to-noise ratio. That's because those white flecks *do* resemble video "snow" with which we are all familiar. Actually, it's easy to tell the difference between video "noise" and tape dropouts. Noise, though random in content, appears all over the picture, and usually throughout the entire tape. Dropouts, on the other hand, occur randomly; they may occur frequently, or there may be periods when the screen is free of flecks. Human vision can tolerate noise more readily than dropouts.

Short- vs. long-term dropouts

It takes approximately 63 microseconds for the electron beam of the

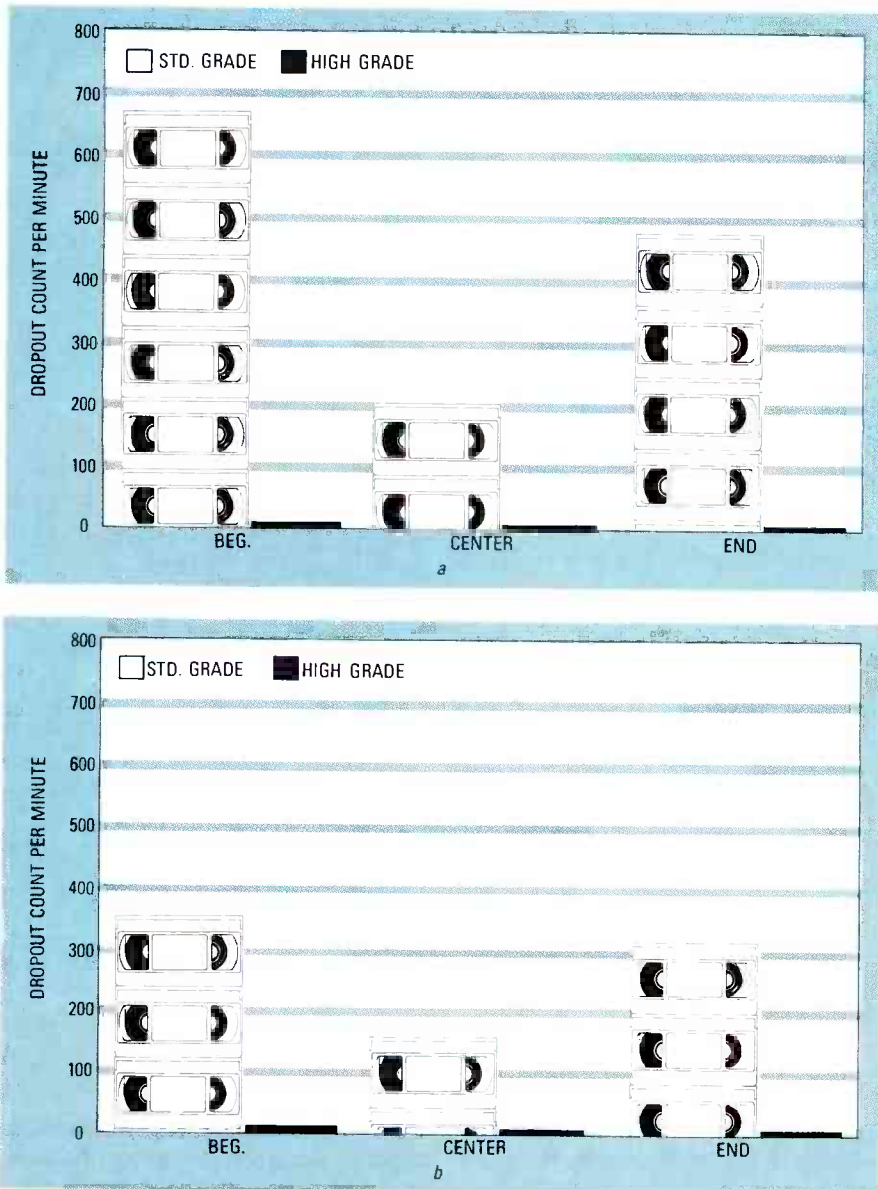

FIG. 1—THE SHORT- (1-a) AND LONG-TERM (1-b) dropout count of standard-grade video tape, compared with the dropout count for high-grade tape. Three values are given because dropout rates are higher at the beginning and end of a tape than at the center.

CRT in an American TV set to “paint” one line of a picture. That being the case, short-term dropouts have been defined as dropouts of 5 microseconds or less. Those would show up as white flecks along a scan line for about $\frac{1}{2}$ th of the length of the line or less. Long-term dropouts are defined as those that cause streaks lasting for 15 microseconds or more. Such dropouts show up as streaks occupying at least $\frac{1}{5}$ th of a scan line and are therefore highly visible and distracting to viewers.

Figures 1-a and 1-b show the short- and long-term dropout count of the very poorest standard-grade video tape, measured in a group of 22 standard-grade tapes, compared with the

short- and long-term dropout count for the very best of 22 high-grade tapes. Three dropout values are given in each case because, as a rule, dropout rates are likely to be higher at the beginning and end of a tape than they are at the center (due to the way videocassettes are manufactured). That’s why seasoned video-tape users fast-forward through the first few minutes of their tapes before recording on them. Most tape suppliers provide a bit more than the nominal recording time, so that practice still permits a full 2-hour recording time (at the SP VHS speed) on a T-120 tape. Figure 1 compares the worst standard-grade tapes with the best high-grade tapes; but on an average, high-grade tapes

exhibit fewer dropouts than the standard-grade tapes.

Signal-to-noise ratios

In evaluating video-tape performance, signal-to-noise (or S/N for short) ratios are also of some significance, but far less so than dropouts. There are three types of S/N measurements that are worth noting. The first, called luminance S/N ratio, is measured with respect to signal brightness or the black-and-white portion of the video signal. The second is known as chroma AM (Amplitude Modulation) S/N, and it defines the color saturation or intensity. The third measurement is called chroma PM (Phase Modulation) noise, and a poor figure here results in a noticeable lack of color purity or accuracy of hues. Generally speaking, viewers are more sensitive to poor luminance S/N ratios than to the other two readings.

Although many manufacturers boast about the high S/N ratios associated with their high-grade tapes, the truth is that the S/N ratios of most tapes—even the standard grades—are better than the inherent S/N ratios of the home VCR’s upon which they are used. Furthermore, the differences between the best readings for the high-grade tapes and the best readings for the standard-grade tapes are relatively small. The same holds true for the poorest readings of the standard-grade when compared with the poorest readings for the high-grade tapes. Figure 2 shows a comparison between standard- and high-grade tape best readings as well as the standard- and high-grade poorest readings. Notice that the very best luminance S/N reading obtained from the high-grade tapes (around 50 dB) was only marginally higher than the best reading obtained from the standard-grade tapes—or about 48 dB.

Similarly, even the worst standard-grade tapes, with regard to luminance S/N readings (a reading of about 46 dB), were only slightly poorer than the worst luminance S/N readings from the high-grade tapes. And, the two poorest readings were generally higher than the S/N ratio of most home VCR’s. Home VCR’s generally exhibit luminance S/N ratios for play and record of not much more than 43 to 45 dB, regardless of the tape used. The same thing pretty much holds true for the chroma AM and chroma PM S/N ratios.

HOW VIDEO TAPES ARE TESTED AND EVALUATED*

Tests of video tapes conducted by APTEL are as rigorous as those conducted by the tape manufacturers themselves, if not more so. All tape tests are conducted in a 70°F. climate-controlled room, with a relative humidity of 60%. The tapes are stored in the room for 48 hours before testing. To ensure accurate results, tapes are bulk-erased and run back and forth in the test deck before testing. Tape decks are thoroughly cleaned after a tape is tested, reducing contamination between samples.

Dropout count



DROPOUT COUNTER used for measuring video dropouts.

For dropout testing, a one-minute long gray field of 50 IRE intensity is recorded on relevant sections of each tape (beginning, middle, and end). (Video brightness is measured in "IRE." 140 IRE, which is the maximum peak-to-peak brightness level for a video signal, corresponds to a completely bright screen, while 20 IRE is, for all intents and purposes, a black screen.) The tape is then played back and any dropout of 20-dB or more is counted and categorized as either a long or short dropout. The device used to measure dropouts is manufactured by *ShibaSoku*, a highly respected Japanese manufacturer of precision test equipment. One of the major causes of dropouts and high signal-to-noise ratios is an irregular tape surface. When such surfaces are suspected as being the cause of poor readings, a powerful microscope/camera combination is used to precisely examine and record the tape surface.

Luminance and chroma

Luminance S/N ratio indicates how much snow or video noise you are likely to see on a black and white video picture. A background signal level of 50 IRE (corresponding to a medium shade of gray) is used as a reference level. Using a noise meter,



NOISE METER used for measuring luma and chroma noise.

unweighted noise is measured over a video bandwidth extending from 10 kHz to 4 MHz, without the usual "trap" circuit at 3.58 MHz. AM chroma noise is similar to luminance noise and appears along horizontal lines of a color picture. PM chroma noise shows up as a change in color rather than as noise or graininess, and is generally less objectionable than either AM or luminance noise. Both forms of chroma noise are measured by the noise meter.

Frequency response

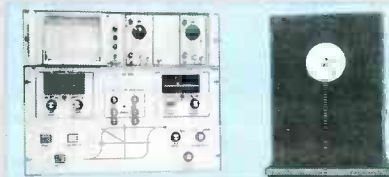

B/H METER used for making magnetic measurements.

Frequency response of video tape is tested by using a multiburst signal consisting of frequencies at 0.5, 1.25, 2, 3, and 3.58 MHz. In the case of some of the newer formulations, such as S-VHS, additional, higher frequency bursts would have to be used. Attenuation at those test frequencies is recorded and a response curve for each tape can be drawn.

As for the magnetic properties of a tape, normally, a B/H meter is used to measure them. That meter can be used to evaluate signal loss with repeated playing of a tape, and magnetic properties such as coercivity and remanence can be measured.

Mechanical properties

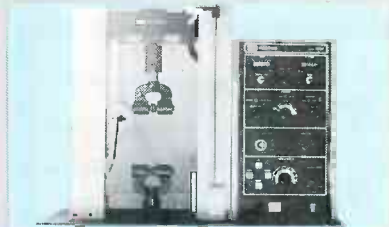

TENSILE TESTER used for measuring elongation and breaking strength.

Base materials of video tapes vary considerably. Some tapes, when under tension, will stretch enough to mar picture quality. Others may have such low tensile strengths that repeated use may actually cause them to tear or break. Elongation and breaking strength can be measured using a calibrated tensile tester. **R-E**

*Mr. Frank Barr of Advanced Product Evaluation Labs (APTEL) has kindly provided the photographs of their test equipment.

Frequency response

Frequency response is directly related to the picture detail or picture resolution that you can expect from a given tape/VCR combination. Horizontal resolution is defined as the number of distinct picture elements that can be discerned across the length of a single scanning line of a TV picture. It should not be confused with the number of scanning lines in the picture itself, which defines vertical resolution. Typically, conventional VHS VCR's deliver between 240 and 260 lines of horizontal resolution at best. That falls somewhat short of the maximum resolution that can be broadcast over the air using the NTSC transmission standard. The rule of thumb is that for every MHz of frequency response in the system, you can expect about 80 lines of horizontal resolution. So, to obtain a resolution of 240 lines, you must have a frequency response to at least 3 MHz, with relatively little attenuation. Figure 3 shows the response (in dB) at a frequency of 3.58 MHz, for the best of the standard- and high-grade tapes, and also for the poorest of both. Even the poorest standard-grade tapes were "down" only around -2.5 dB at 3.58 MHz and, surprisingly, the poorest high-grade tapes were actually down a fraction more at that high video frequency.

The truth is that just about any video tape will exhibit a frequency response that's considerably better than the limitations of the home VCR. Of course, we are only talking about conventional VHS, Beta, and 8-mm video recorders and tapes. If you happen to own one of the new S-VHS machines, the story is quite different. Those machines are capable of delivering 400 or more lines of horizontal resolution, and require special S-VHS tapes that use metal particles instead of an oxide of magnetic particles in their formulations. S-VHS tapes will generally exhibit a frequency response extending all the way out to 4.2 MHz, or even to 5.0 MHz, but those benefits will not be realized if the S-VHS tapes are recorded on or played back using a conventional VHS machine.

Repeated plays

How long will most video tapes last? If you are using a tape to record a once-in-a-lifetime family event or a major sports event that's not likely to

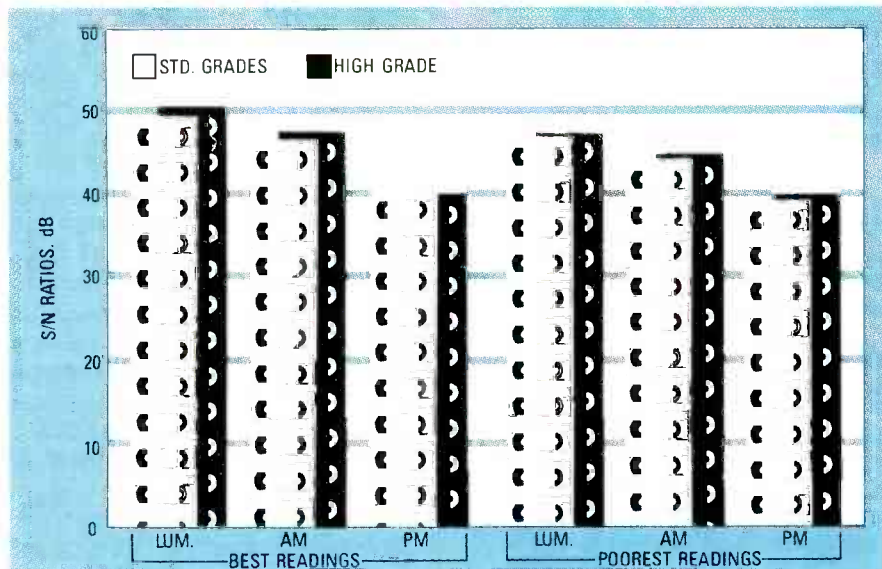

FIG. 2—A SIGNAL-TO-NOISE COMPARISON between standard- and high-grade video tape. Notice marginal differences between tape grades in this respect.

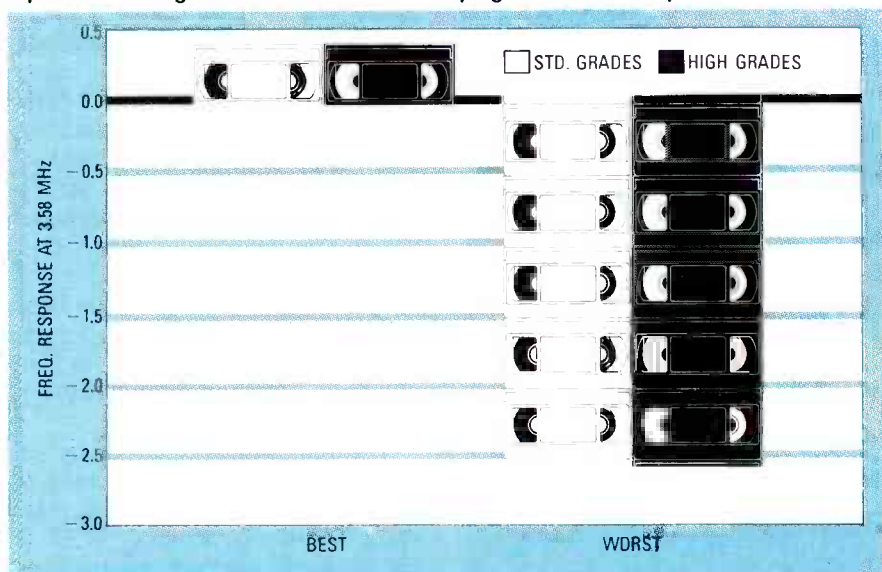

FIG. 3—FREQUENCY RESPONSE IN dB, at a frequency of 3.58 MHz, for the best and poorest of the standard- and high-grade tapes.

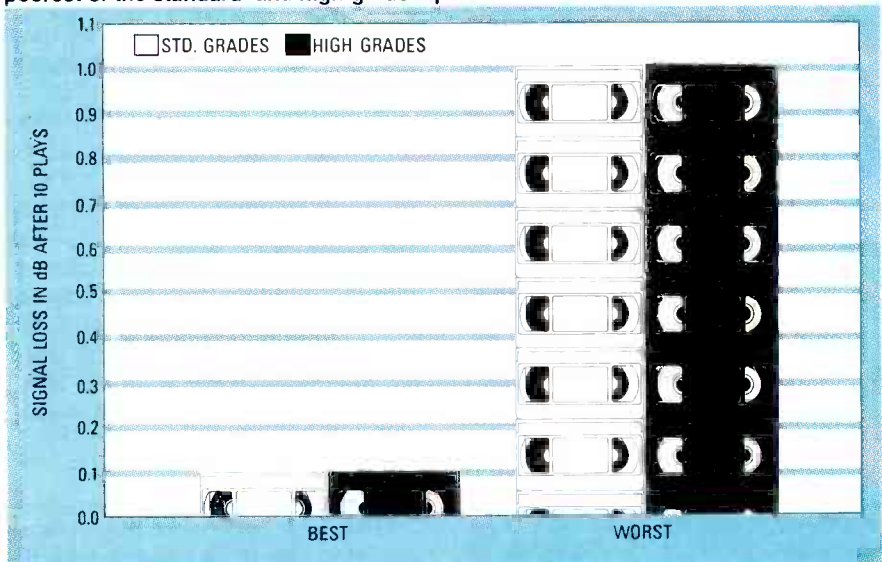

FIG. 4—THE BEST VIDEO TAPES lost 0.1 dB in signal level after 10 plays, while the worst of them lost less than 1 dB after the same number of plays.

be repeated or available on pre-recorded tape, the question of durability is important. If you are simply recording a program "off the air" for viewing at a more convenient time, after which you plan to record something over it, then durability is of little importance. Most video tapes are excellent in their ability to preserve picture and sound with repeated playing with very little loss of signal level. Furthermore, there seems to be little difference between the standard- and high-grade tapes insofar as signal loss with repeated playing is concerned. That is illustrated in Fig. 4, where we see that the best standard- and high-grade tapes lost a mere 0.1 dB in signal level after 10 plays, while the worst standard- and high-grade tapes lost less than 1 dB after the same number of plays.

Audio performance

If you own a VHS or Beta VCR that has hi-fi audio, virtually any tape that produces good video with minimum dropout will also deliver wide-response, low-distortion stereo audio. That's because the audio signals are recorded as FM carriers along with the video signals, on the same area of the tape. The same holds true for 8-mm camcorders or VCR's where AFM (Audio Frequency Modulation) audio recording is mandatory, even if the audio is only single-channel. Audio troubles arise when you own a VCR that uses the edge of the tape for so-called "conventional" or "linear track" audio recording.

The limited frequency response of the audio electronics of most VCR's is likely to be poorer than the capability of most tapes. You may also find that some inferior tapes have been slit improperly, and will exhibit dropouts of the sound recorded on the track closest to the edge of the tape. Friction within the cassette housing can also result in high levels of "wow" and "flutter," or variations in pitch when playing back musical programming.

Which tape to use?

There's no single answer to that question. It all depends upon the type of recording you do, what you plan to do with it, and how important the finished tape is to you. Dropouts remain the single most important criterion by which to judge video tape. And once you find the brand that suits your needs, stick with it. **R-E**

ALL ABOUT

CAPACITORS

*Everything you were always afraid to know
about capacitors...but wanted to ask*

JOSEF BERNARD

ASIDE FROM THE OCCASIONAL HUMAN body or lightning-struck tree that acted as an inadvertent resistor, capacitors were probably the first electronic components. When electricity was discovered and its mysteries were first being explored back in the mid-1700's, capacitors were the means used to store the mysterious new force.

Of course, they weren't called capacitors then. They were called *Leyden jars* (see Fig. 1). A popular diversion at parties of the time was to charge up a Leyden jar, form a ring of people by holding hands (the circuit), and then discharge the jar through the ring. Talk about getting a glow on!

A Leyden jar (named for the city of Leyden in Holland) was a glass container lined with, and covered on the outside with, metal foil. (The first Leyden jar probably had only one plate, a foil lining on the inside. It would have been able to hold something of a charge, but not much. The

addition of the second exterior electrode provided a "vessel" for the positive charge that complemented the negative one on the inner electrode.) When the inner foil was charged up (loaded with electrons), the glass prevented them from traveling to the outer foil, and a voltage differential was established. Ignoring the question of leakage, the jar would then hold that electric charge until the charges on the inner and outer foils were equalized—perhaps through a ring of merry-makers or in the form of miniature lightning—a spark—jumping between two pointed electrodes. That was the first capacitor.

We have progressed somewhat since those days, both in the ways we seek our thrills, and in our uses for capacitors and the ways in which we construct them.

How capacitors work

A capacitor (it used to be referred to as a condenser because it seemed to

condense, or concentrate electricity) is an apparently simple device. Two plates of metal separated by an insulator, which, when found in a capacitor, is known as a dielectric. You charge up one of the plates with electrons (or create a deficiency of electrons), and the dielectric keeps them from traveling to the other plate, which becomes oppositely charged with respect to the first. The opposite charges attract one another (they would mutually neutralize themselves if the dielectric were not there to keep them apart) and form a stable system.

What actually happens is a little more complicated than that. The dielectric material plays more of a role than just keeping the two plates of the capacitor separated and preventing the charge from migrating from one to the other. For it is the dielectric itself, that actually determines how much of a charge a capacitor can hold. The dielectric material itself can become



FIG. 1—LEYDEN JARS, the earliest capacitors, found their first use outside the laboratory as ice-breakers at parties.

electrically charged. A sort of tidal effect takes place within it and the electrons on one side are repelled by the electrons on the adjacent negative plate of the capacitor, while those on the other side of the dielectric are attracted by the positively charged plate.

The degree to which that effect manifests itself determines what is known as the dielectric constant, abbreviated as K, of the insulating material. The dielectric constant is a number expressing how much the capacitance of a device increases when that particular material is used instead of just separating the plates of the

TABLE 1
DIELECTRIC CONSTANTS (K)
OF VARIOUS MATERIALS

| Material | K |
|-------------------|-----------|
| Air (vacuum) | 1 |
| Paraffin | 2-3 |
| Rubber | 2-3 |
| Polyethylene | 2-3 |
| Paper | 2-4 |
| Oil | 3-5 |
| Mica | 4-8 |
| Porcelain | 5-7 |
| Glass | 6-9 |
| Titanium dioxide | 14-110 |
| Various titanates | 15-12,000 |

capacitor with a vacuum, whose dielectric constant is expressed as unity, or one. Table 1 shows the dielectric constants of some common materials.

There are three ways in which the capacitance of a device can be increased. The first is merely by increasing the size of the plates so there is room for more electrons. More important, increasing the size of the plates increases the amount of surface area in contact with the dielectric. In today's microminiature circuits, however, that is not an ideal solution, nor has it ever been. Size and materials are always a consideration.

The second method involves bringing the oppositely charged plates closer together. One way of doing that is to make the plates and the dielectric material as thin as possible. As their proximity increases, the mutually attractive force on them becomes greater as the inverse of the square of the distance separating them. That is, halving the distance between the plates increases the attraction by a factor of four; quartering it increases it sixteenfold. The increased attraction means that more electrons can be held in place. (It should be noted that one of the electrodes of a capacitor is usually connected to ground. That provides it with a practically infinite supply of positive charge.) Unfortunately, there comes a point where the plates of a capacitor would be so close together that the electrons would jump the gap; that would destroy the dielectric in the process, and neutralize any charge that was on the plates.

The third method of increasing capacitance involves using materials with high dielectric constants. Those materials, as we have seen, can by themselves stabilize the charge on the electrodes of a capacitor, and the greater the dielectric constant of a material, the more of a charge can be stored by device in which it is used. It is the improved dielectric materials that have contributed largely to the increase in the capacitance-to-size ratio of today's capacitors.

Capacitance, the ability of a capacitor to store a charge, is measured in farads, a unit named in honor of electrical pioneer Michael Faraday. (Never use the term "capacity" when speaking of capacitors; it is not interchangeable with the term "capacitance.") A farad is defined as one coulomb of electricity applied at a

potential of one volt. It is no trivial unit, since a coulomb contains 6.25×10^{18} (6.25 thousand million billion!) electrons.

Most applications do not require anything close to a farad of capacitance, which is fortunate because until recently it was impossible to make anything near a 1-farad capacitor in a reasonable size (see Fig. 2). Today, even Radio Shack sells 0.1-farad capacitors for just a few dollars.

However, most capacitors are much smaller in value than that. Capacitance is commonly measured in microfarads (millionths of a farad) or picofarads (trillionths of a farad). Picofarads, which are millionths of a microfarad, used to be called micro-microfarads. The term "microfarad" is abbreviated μF , and picofarad, pF. Capacitors with values in that range are sufficiently large for most electronic circuits.

How are capacitors used?

Pick up any circuit board, open any power supply, look inside any piece of radio equipment, and you're going to find capacitors. What are they all doing in there? Well, as you might have guessed, capacitors are more than just solid-state electrical storage devices. When direct current (DC) is involved, that's more or less what they are. Put a charge on them and they retain it, or as much of it as the inevitable leakage will allow. As such, their usefulness in DC circuits is somewhat limited. But in AC circuits, where the magnitude and the polarity of the voltage is constantly changing, the roles that capacitors play are enormously varied.

Capacitors block DC; once they are fully charged, no current flows into or



FIG. 2—THIS CARTOON was funny a few short years ago, but it has been made obsolete by today's improved technology.

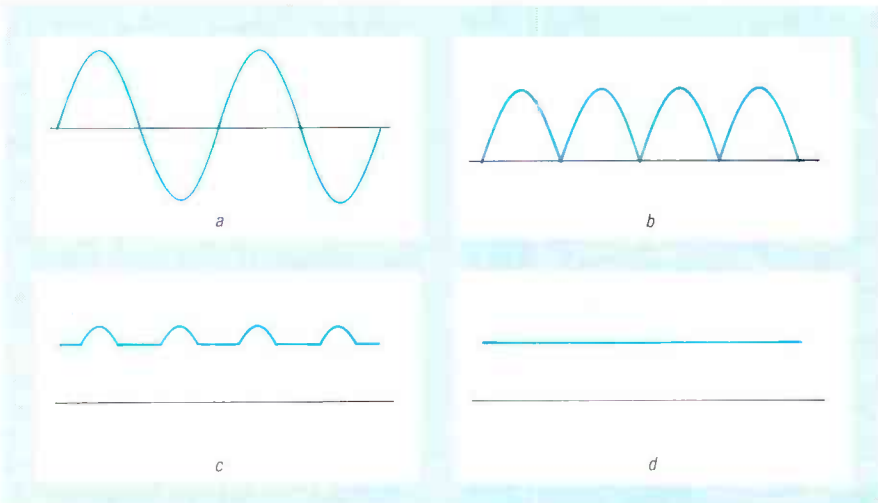

FIG. 3—ORIGINAL (a) AND RECTIFIED (b) AC waveforms. A large capacitor in the power-supply circuit smooths out the waveform, but still leaves a ripple component (c). Smaller-value capacitors bypass that ripple to ground, leaving pure DC (d).

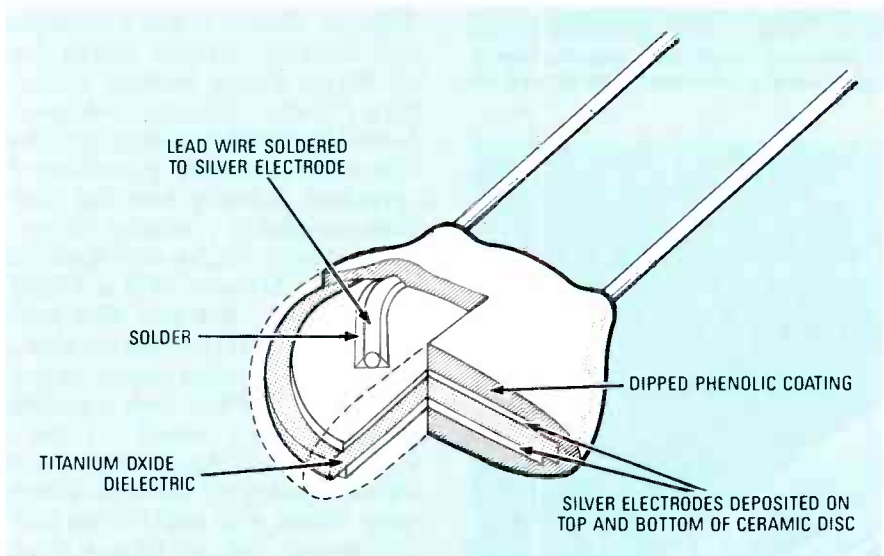

FIG. 4—CERAMIC DISC CAPACITORS are very simple. Two plates are separated by a titanium dioxide dielectric, and the entire assemblage is protected with a phenolic coating.

out of the capacitor. However, capacitors do pass AC. That is because as the charge on one electrode of the device varies, the charge on the other electrode (even if it does not change) also varies with respect to the first. The system is no longer stable. A varying electric potential is developed across the capacitor and current flows through it.

That ability of capacitors to block DC while passing AC makes them invaluable in places where only one or the other is desired. Digital logic circuits, when they switch from one state to another (say from logic-high to logic-low), frequently generate transients or spikes on the power-supply lines. If not cared for, those transients would

influence the operation of the logic circuits and generate unpredictable results. For that reason, for every few IC's on a board, the power-supply lines are bypassed to ground through despiking capacitors. Those capacitors see the switching transients as a form of AC (which they are) and conduct them to ground. The normal supply voltage, being constant DC, is unaffected by their presence.

In a power-supply circuit, when alternating current is rectified, the result is not immediately pure DC. Rather, it is an alternating voltage having a single polarity. Figure 3-a shows an AC waveform, and Fig. 3-b shows the same waveform after being rectified. The large capacitors, commonly

found in power-supply circuits, act as surge tanks. That is, as the voltage applied to them changes upward, they begin to charge. Then, as the applied voltage begins to decrease, they lose some of their electrons to the supply line. Figure 3-c shows the rectified AC waveform *after* being applied to the large capacitor.

However, there is still an AC component left in the output voltage that cannot be compensated for completely by the large capacitors. That component, called ripple, is a remnant of the original AC voltage (Fig. 3-c). To remove it, smaller capacitors are used to convey the electrons making up the difference between the value of the ripple voltage and that of the mostly DC output voltage to ground. The result (Fig. 3-d) is pure DC.

In many circuits where AC and DC are mixed, it is often desirable to pass one while blocking the other. Such a situation might exist between the stages of an audio amplifier. In order to pass the output of the first stage to the input of the second, without also passing along the high DC collector voltage from the first stage, a coupling capacitor between the two stages is used. It blocks the unwanted DC while passing the AC. Capacitors can also be used to keep the DC component of a signal, and get rid of the AC one. That is done by passing the AC component to ground.

Another place where capacitors play an extremely important role is in timing circuits. The timers involved may be considered long-interval or short-interval ones. Long-interval timers are the type found in clock circuits and other applications where some sort of time-measuring capability, or the generation of a signal used for timing, is involved. Short-interval timing circuits are the sort that generate high-frequency signals such as those used in radio and television transmission, or in microwave devices.

Because capacitors do not charge instantaneously, and because it always requires the same amount of time to charge or discharge a given capacitor to a given state, the charging time can be taken advantage of. By charging or discharging a capacitor through a resistor, or perhaps an inductor, a *time constant* can be established. That time constant can be related to the pulses of a timing circuit, a resonant frequency, etc.

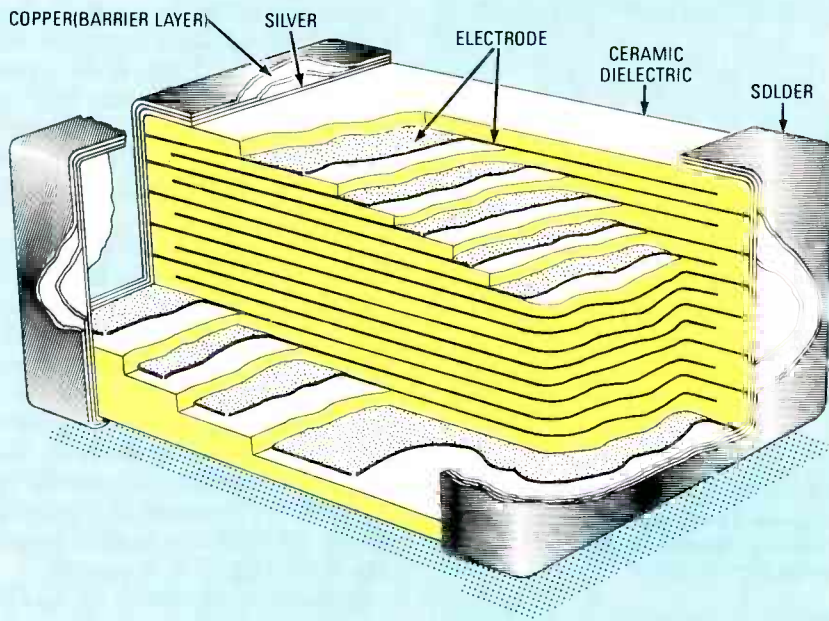

FIG. 5—PRINTED-CIRCUIT CERAMIC-CHIP capacitors use a multi-layer construction to enlarge the electrode surface area. Conductive ink is used to print electrodes directly on the substrate.

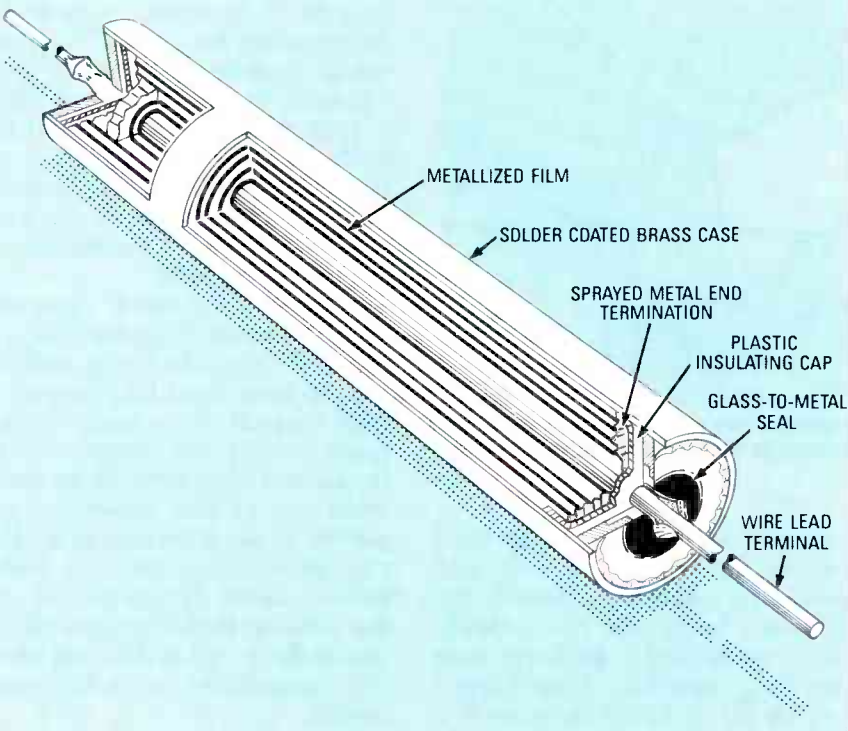

FIG. 6—TUBULAR ELECTROLYTIC CAPACITOR uses a rolled-up electrode to maximize anode surface area. The outer shell of the capacitor, which is in contact with the electrolyte, serves as the cathode.

Capacitor construction

The variety of capacitors, if not infinite, is certainly large enough to be astonishing. Excluding those capacitors used in very specialized applications, there are still enough different types to keep you counting all night. When it comes right down to it,

though, there are just a few types of capacitors commonly used in electronic circuits.

Ceramic capacitors are typically represented by the ubiquitous ceramic disc capacitor and its recent offspring, the multi-layer ceramic chip capacitor. An ordinary disk capacitor, as

shown in Fig. 4, is little more than two very thin sheets of metal separated by a dielectric—usually a form of titanium dioxide—and encased in a “lollipop” of ceramic. That relatively unsophisticated design is adequate enough to provide up to several thousand picofarads at ratings of up to several kilovolts. (The voltage rating is important; If too high a voltage is applied to a capacitor, the electrode material may be punctured or, even worse, the device may explode.)

Ceramic chip capacitors, sometimes known as printed-circuit capacitors, are similar in principle, but are frequently supplied in leadless form, intended for surface mounting. To achieve their small size with a reasonable degree of capacitance, the electrodes are stacked like a multi-layer club sandwich, as shown in Fig. 5. That, in effect, makes a capacitor with many sets of plates, and by electrically connecting alternate plates, a capacitor with a large electrode area is formed. Rather than using a metal foil to form the electrodes, printed-circuit capacitors actually have the electrodes printed in a metallic ink on a ceramic dielectric, having a dielectric constant of between 2000 and 6000.

Electrolytic capacitors offer much higher capacitances than ceramics, although their voltage ratings are generally lower. While their dielectric constants rarely exceed 25, that is compensated for by the thinness of their electrodes and the consequently large surface area available for electron storage. They are frequently recognizable by their cylindrical (tubular) form, although in the past ten or fifteen years, teardrop-shaped dipped tantalum electrolytics have become increasingly common.

Aluminum electrolytics are probably the most widely used type today, and their construction illustrates how electrolytics differ from other types of capacitors. While the capacitors we discussed earlier use two similar plates, electrolytic capacitors actually have only one plate in the traditional sense. That plate is made of a very thin sheet of aluminum. The other “plate” consists of a conducting electrolyte (hence the term “electrolytic”) applied to a material such as plastic film or (in the early days) paper. Early electrolytes were liquids, but less-messy paste electrolytes rapidly took over for the most part. The two elements of the capacitor are

Be an FCC LICENSED ELECTRONIC TECHNICIAN!



Earn up to \$30 an hour and more!

Learn at home in spare time. No previous experience needed!

No costly School. No commuting to class. The Original Home-Study course prepares you for the "FCC Commercial Radio-telephone License". This valuable license is your "ticket" to thousands of exciting jobs in Communications, Radio-TV, Microwave, Computers, Radar, Avionics and more! You don't need a college degree to qualify, but you do need an FCC License.

No Need to Quit Your Job or Go To School This proven course is easy, fast and low cost! **GUARANTEED PASS**— You get your FCC License or money refunded. **Send for FREE facts now. MAIL COUPON TODAY!**

COMMAND PRODUCTIONS

FCC LICENSE TRAINING, Dept. 90
P.O. Box 2824, San Francisco, CA 94126

Please rush FREE details immediately!

NAME _____
ADDRESS _____
CITY _____ STATE _____ ZIP _____

NEW SUPER LONG PLAY TAPE RECORDERS

12 Hour Model — \$119.00*
USES D-120 TAPE
Modified Panasonic Slimline, high quality, AC-DC Recorders provide 6 continuous hours of quality recording & playback on each side of 12 hours.
Built-in features include:
• Voice level control • Digital counter, etc. TDK DC 120 Cassette Furnished.

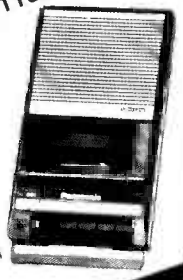

PHONE RECORDING ADAPTER

Records calls automatically. All Solid state connects to your telephone jack and tape recorder. Starts recording when phone is lifted. Stops when you hang up. **\$24.95*** FCC APPROVED!

VOX VOICE ACTIVATED CONTROL SWITCH

Solid state. Self contained. Adjustable sensitivity. Voices or other sounds automatically activate and control recorder. Uses either recorder or remote mike. **\$28.50***
*Add for ship & hdg. Phone Adapter & Vox \$1.50 ea. Recorders \$4.00 ea. Cal. Res. add tax. Mail order, VISA, MIC, COD's OK. Money Back Guarantee. Free data. avail. Dealer inquiries invited. Free data.
AMC SALES INC. Dept. A9335 Lubec St., Box 928, Downey, CA 90241 Phone (213) 869-8519

MAY 1989

CIRCLE 108 ON FREE INFORMATION CARD

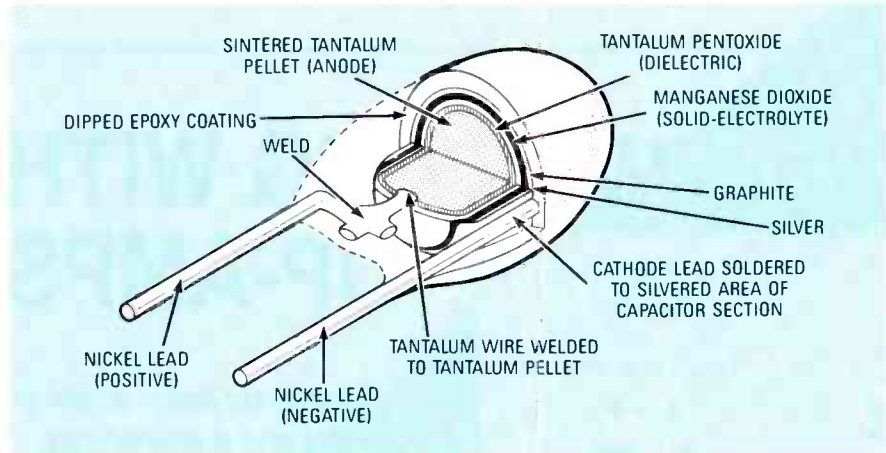

FIG. 7—TANTALUM ELECTROLYTICS, sometimes called "tantalytics," use a slug of sintered tantalum powder with a manganese dioxide electrolyte.

insulated from one another by a layer of oxide—aluminum oxide in this case—formed on the surface of the aluminum electrode. Figure 6 shows a "jelly roll" tubular electrolytic capacitor. To increase the surface area of the plates (and consequent contact with the electrolyte), the two plates are frequently roughened by an etching process.

Tantalum electrolytics, which may be cylindrical or teardrop shaped, use the same principle of a single metallic electrode in conjunction with an electrolyte. However, rather than being a sheet of metal, the electrode is actually a slug of extremely porous tantalum powder (see Fig. 7). The surface of the power grains is anodized to produce tantalum oxide, the insulator. The tantalum slug is impregnated with a liquid electrolyte containing manganese nitrate. The electrolyte solution is absorbed by the porous slug and the liquid is then evaporated, leaving manganese dioxide (formed during the evaporation process) throughout the slug to act as electrolyte. Tantalum capacitors are known for their long-term stability and low leakage. They are also very small in size. Their popularity, however, seems to fluctuate according to the price and availability of tantalum. When it is in short supply, aluminum electrolytics are frequently fallen back upon, but usually tantalums are preferred because of their highly desirable characteristics.

Electrolytic capacitors differ from non-electrolytic devices in that they are polarized. That is, because of the process used to form the insulating oxide, the metallic electrode is always positive with respect to the elec-

trolyte, and must be connected to a positive voltage. Connecting the positive lead or terminal of an electrolytic capacitor to a negative voltage would quickly, and rather violently destroy it. Because of that, electrolytics are suitable for use only with DC (or at least where the potential does not change from positive to negative).

Most types of capacitors can be destroyed by over- or reverse-voltage situations where holes may be blasted in the plates or the dielectric material. However, electrolytics—although not the tantalum sort—have the unusual ability to heal themselves, at least where the degree of damage is relatively minor (a destroyed capacitor will never work).

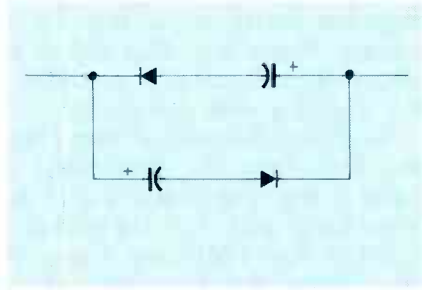

FIG. 8—A NON-POLARIZED electrolytic capacitor can be made by hand if you can't find the value that you need.

Occasionally you will find reference to non-polarized electrolytic capacitors. They are constructed by connecting two ordinary electrolytics back-to-back, frequently using series diodes to prevent reverse-current flow (see Fig. 8). Non-polarized electrolytics are frequently found in audio applications such as in crossover networks.

R-E

WORKING WITH OP-AMPS

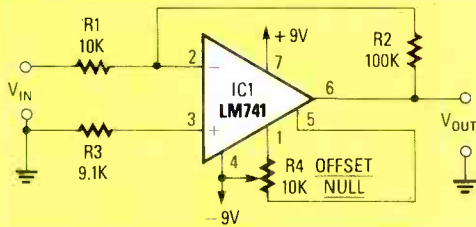

FIG. 1—INVERTING DC AMPLIFIER with offset nulling and $\times 10$ voltage gain.

NOTES:

$$A_V = \frac{R_2}{R_1}$$

$$V_{OUT} = -A_V \times V_{IN}$$

$$Z_{IN} = R_1$$

$$R_3 = R_1 || R_2$$

Op-amp du jour—a little of this and a little of that.

RAY MARSTON

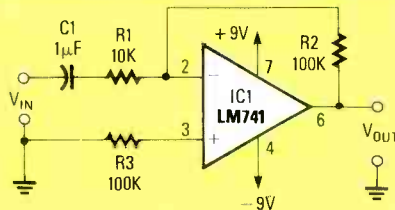

FIG. 2—INVERTING AC AMPLIFIER with $\times 10$ voltage gain.

NOTES: $R_3 = R_2$

$$\text{CLOSED-LOOP BW} = \frac{F_T}{A_V}$$

$F_T = \text{OPEN-LOOP BANDWIDTH}$

$$A_V = \text{CLOSED-LOOP GAIN}$$

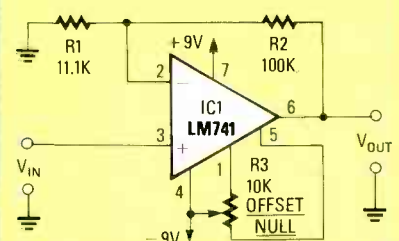

FIG. 3—NON-INVERTING DC AMPLIFIER with offset nulling and $\times 10$ voltage gain.

$$A_V = \frac{R_1 + R_2}{R_1} = \frac{R_2}{R_1} + 1$$

LET'S DESIGN CIRCUITS AROUND THE STANDARD LM741 op-amp, powered by a ± 9 -volt supply. Starting with inverting and non-inverting configurations, and how they work, we'll move on to voltage followers, biasing theory, adders and subtractors, and phase splitters. We'll finish up with active filters. In practice, however, as long as the supply voltage stays the same, any op-amp can be substituted for the LM741 without modifying any of our circuits.

Inverting op-amp

Figure 1 shows an inverting DC-amplifier with an overall voltage gain (A_V) of 10. The voltage gain is determined by the resistance ratio R_2/R_1 ; by substituting a potentiometer for fixed resistor R_2 , the voltage gain can be made variable. The V_{OUT} formula shows the gain (A_V) to be negative because the output voltage is inverted 180 degrees from the input.

Offset nulling via R_4 is used to adjust the output voltage to zero when the input voltage is zero. If the offset-nulling network is removed, the output voltage will be offset by an amount equal to the op-amp's input-offset voltage (typically 1 mV) multi-

plied by the closed-loop voltage gain (A_V). For example, if the circuit has a gain of 100, the output may be offset by 100 mV when both inputs are grounded. For offset biasing stability, R_3 should have a value equal to the parallel value of R_1 and R_2 .

As shown in Fig. 2, by wiring a coupling capacitor in series with the input resistor R_1 , an AC amplifier is created. Notice that offset nulling is not needed and, for optimum biasing, R_3 is given a value equal to R_2 .

In the small-signal AC amplifier, the closed-loop BW (bandwidth) is equal to the open-loop BW (F_T) divided by the gain (A_V). For example, when the F_T is 1 MHz and A_V equals 10, then the closed-loop BW equals 100 kHz. The F_T value for any op-amp is obtained from the manufacturer's specification sheet: The LM741's F_T is typically 1 MHz.

Non-inverting op-amp

Shown in Fig 3 is a non-inverting $\times 10$ DC amplifier with offset compensation. The voltage gain is determined by $[(R_2/R_1) + 1]$. If R_2 is given a value of zero (a short circuit), the gain falls to unity. As shown in Fig. 4, the gain can be made variable, over

FIG. 3—NON-INVERTING DC AMPLIFIER with offset nulling and $\times 10$ voltage gain.

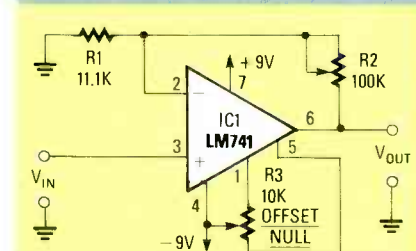

FIG. 4—NON-INVERTING VARIABLE-GAIN DC amplifier.

the range of 1 to 101, by replacing R_2 with a potentiometer and connecting the wiper to the inverting input. The parallel value of R_1 and R_2 should ideally (for optimum biasing) be equal to the source resistance of the input signal. A major feature of the non-inverting op-amp is its high input-impedance, which can easily have a value of hundreds of megohms.

Figure 5 shows a $\times 10$ non-inverting AC amplifier. Notice, here, that gain-control resistors R_2 and R_1 are isolated from ground via the bypass capacitor C_2 . At operating frequen-

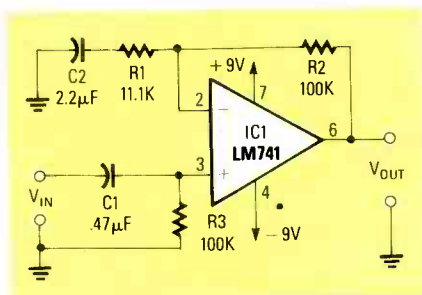

FIG. 5—NON-INVERTING $\times 10$ AC amplifier with 100,000-ohm input impedance.

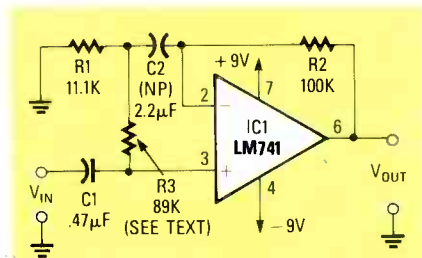

FIG. 6—NON-INVERTING $\times 10$ AC amplifier with 50-megohm input impedance.

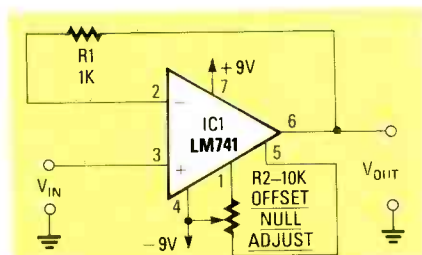

FIG. 7—DC VOLTAGE FOLLOWER with offset nulling.

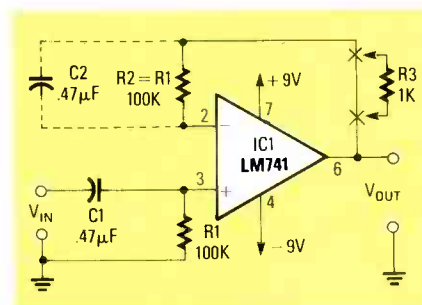

FIG. 8—AC-VOLTAGE FOLLOWER with 100,000-ohm input impedance.

gies, C2 has negligible impedance, so the AC-voltage gain is determined by the R2/R1 ratio; however, because there's no return path for output DC to ground, the inverting input is subject to virtually 100% DC negative feedback, that is, unity gain. But for unity gain, wouldn't resistor R2 need to be a direct short for 100% feedback? Not quite; let's see why.

Except for input-offset currents, no DC current flows through feedback resistor R2, so there's no voltage drop and, consequently, whatever voltage

appears at the output (pin 6) also appears at the inverting input (pin 2). It sounds surprising, but as far as DC is concerned, R2 looks like a short circuit from pin 6 to pin 2. For optimum input-current biasing, R3 should have a value equal to that of R2. Clearly, the non-inverting input impedance equals the R3 value.

Figure 6 shows how to design for a high input impedance (typically 50 megohms). The low end of R3 is taken to ground via R1, and the AC-feedback signal appearing at the R3-R1 junction is virtually identical to that appearing on the non-inverting input. Consequently, near-identical signal voltages appear at both ends of R3, which thus passes negligible signal current. The apparent impedance of that resistor is increased to near infinity by that "bootstrap" action. In practice, however, the input impedance is limited to about 50 megohms because of the op-amp's socket and PC-board impedances. For optimum input-current biasing, the sum of R2 and R3 should equal R1.

Voltage follower

A voltage follower produces an output signal identical to the input signal. The circuit functions as a unity-gain non-inverting amplifier with 100% negative feedback, where the input impedance is very high and the output impedance is very low. Figure 7 shows a voltage follower with offset nulling; however, there would be an output error of only a few millivolts by eliminating the offset nulling entirely. Notice that, for optimum input-current biasing, feedback resistor R1 should have a value equal to the source resistance of the input signal.

The value of feedback resistor R1 can be varied over a wide range (from zero to 100,000 ohms) without greatly influencing the output accuracy. If an op-amp has a low open-loop BW, the

R1 value can usually be reduced to zero. However, many op-amps with a high open-loop BW tend towards instability when used in the unity-gain mode. To reduce the bandwidth and enhance op-amp stability, R1 should be 1000 ohms or greater.

Figure 8 shows an AC version of the voltage follower. Here, the input AC-signal is coupled through C1, and the non-inverting input is tied to ground via R1, which determines the input impedance. Ideally, feedback resistor R2 should have the same value as R1 for correcting input-current offsets. However, if R2's value is very high, it may reduce the bandwidth too much; that problem can be overcome by shunting R2 with C2. Further stability can be achieved for high open-loop BW op-amps by connecting R3 in series with R2.

Figure 9 achieves an extremely

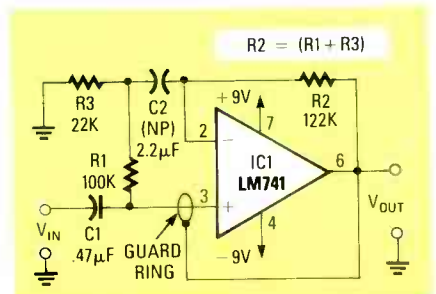

FIG. 9—AC VOLTAGE FOLLOWER with 50-megohm input impedance without guard ring, or 500 megohms with the guard ring.

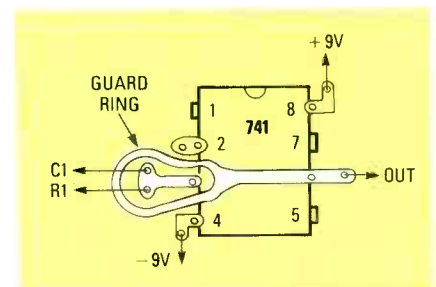

FIG. 10—GUARD RING ETCHED ON A PCB as viewed through the top of the PC board.

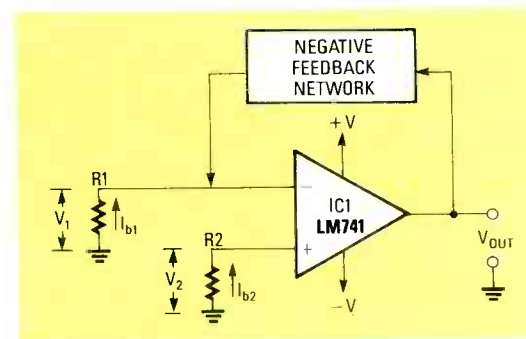

FIG. 11—INPUT BIASING of an op-amp.

$$\text{NOTES: } I_{b1} = I_{b2} = I_b$$

BIASING OUTPUT ERROR:

$$V_{OUT} = I_b (R2 - R1)A_v$$

$$= A_v(V_2 - V_1)$$

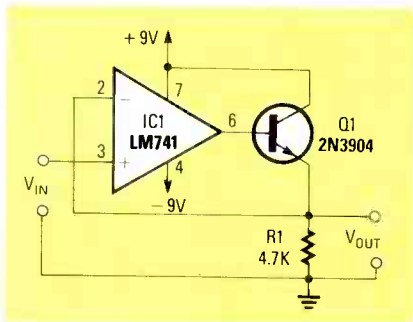

FIG. 12—UNI-DIRECTIONAL BOOSTED output-current drive in a DC voltage follower.

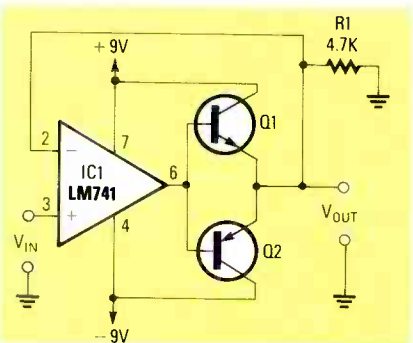

FIG. 13—BI-DIRECTIONAL BOOSTED output-current in a DC voltage follower.

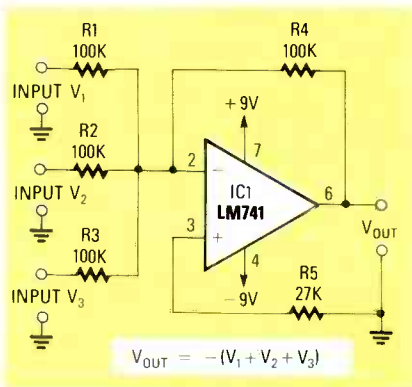

FIG. 14—UNITY-GAIN DC ADDER.

high input impedance, where R1 is "bootstrapped" from the op-amp output via C2, causing R1's impedance to increase to near infinity—resulting in about a 50-megohm input impedance. The input impedance is still limited by the leakage impedances of the op-amp's IC socket and PCB, which can also be bootstrapped and raised to near-infinite values by using a printed circuit "guard ring" surrounding the op-amp's input pin. In that case, Fig. 9 would have a 500-megohm input impedance when using a LM741 op-amp, or even greater if a FET-input op-amp is used. Figure 10 shows a guard ring etched on a PCB.

Biassing accuracy

In Figs. 1 through 9, great emphasis was placed on selecting component values for optimum input biasing. Figure 11 shows a circuit for testing the input-offset bias. Both inputs are tied to ground via resistors R1 and R2; equal input bias currents, I_{b1} and I_{b2} , are drawn through those resistors, thereby generating equal voltage drops. Because a zero-differential voltage appears across the input, a biasing error of zero volts will appear at the output. If, on the other hand, R1 and R2 do not have equal values, or the input bias currents are slightly different, the voltage drops across each resistor will differ; that will produce an input differential voltage that will be amplified by A_V to produce an

output-offset voltage. How significant is that output-voltage error, really?

In practice, a bipolar op-amp such as the LM741 has a typical I_b value of about 200 nA (0.2 μ A), producing a voltage drop of 0.2 mV across a 1000-ohm resistor. FET-input op-amps have typical I_b values of about 0.02 nA, producing a voltage drop of a mere 0.02 μ V across a 1000-ohm resistor. Therefore, in Fig. 11, if the R1 and R2 values differ by as much as 10,000 ohms, a LM741 op-amp will produce a biasing output error of only 2 mV in a unity-gain voltage follower, or 20 mV for a $\times 10$ amplifier. If a FET-input op-amp is used in place of the LM741, the biasing output error of the voltage follower will be a mere 0.2 μ V, and for the $\times 10$ amplifier, a mere 2 μ V.

It follows that Figs. 1 through 9 can accept considerable latitude in their biasing component values. With that in mind, let's look at more circuits.

Current-boosted follower

Most op-amps can provide maximum output currents of only a few milliamperes. However, as shown in Fig. 12, the current-driving capacity of a voltage follower can be easily increased by wiring an emitter-follower transistor to the output. Notice that the base-emitter junction is wired into the negative-feedback loop, which virtually eliminates the effects of junction non-linearity. That technique is not used in Fig. 13, which

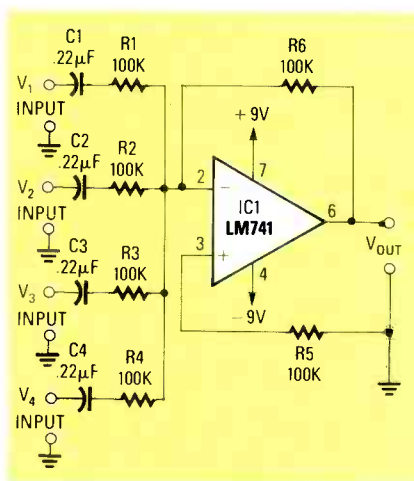

FIG. 15—4-INPUT AUDIO MIXER.

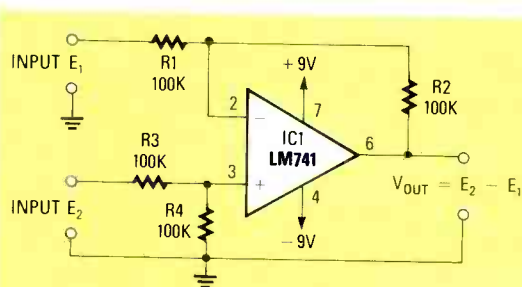

FIG. 16—DIFFERENTIAL AMPLIFIER, or subtracter.

NOTES:

WHEN, $R_1 = R_3$
 $R_2 = R_4$

THEN, $A_V = \frac{R_2}{R_1}$

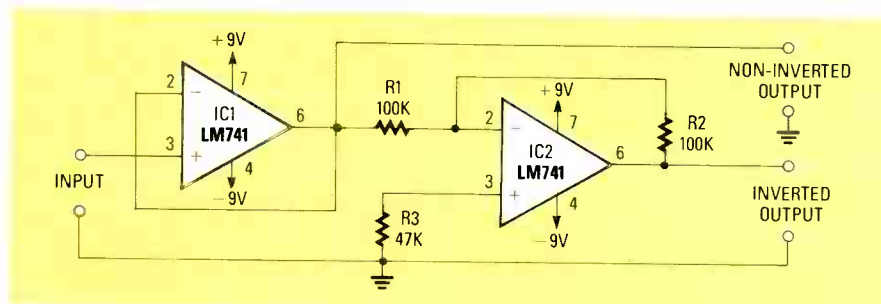

FIG. 17—BALANCED PHASE-SPLITTER.

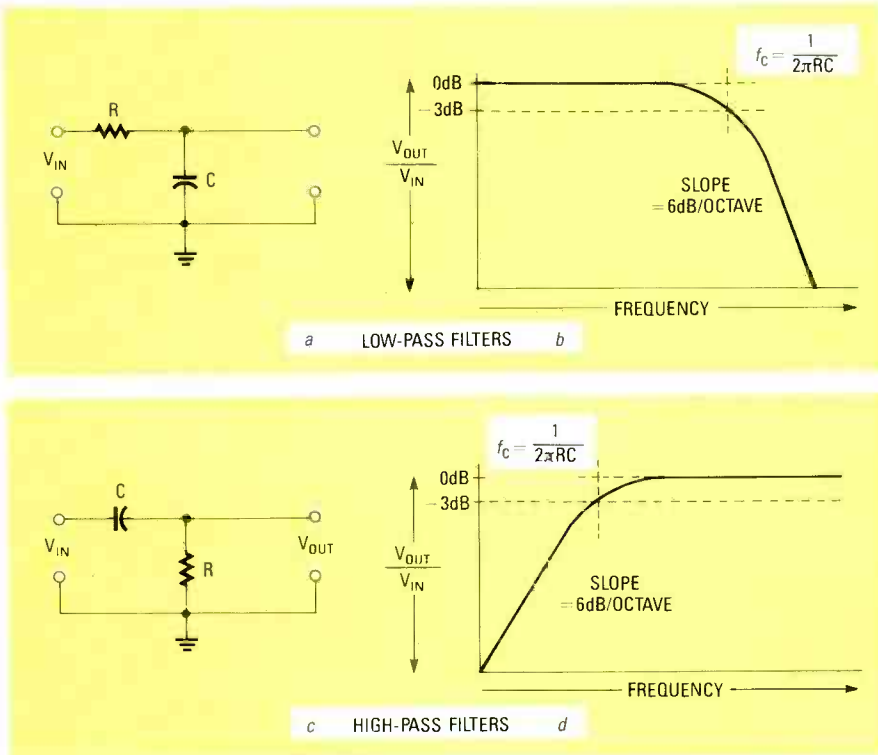

FIG. 18—1st-ORDER RC FILTERS FREQUENCY RESPONSE CURVES: (a) is a passive low-pass filter, and (b) is its frequency response; (c) is a passive high-pass filter, and (d) is its frequency response.

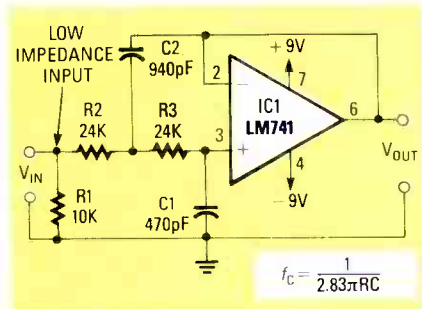

FIG. 19—2ND-ORDER LOW-PASS 10-KHZ unity-gain active filter.

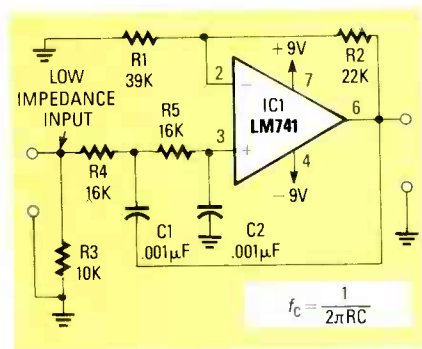

FIG. 20—2ND-ORDER LOW-PASS 10-KHZ equal-value-component active filter.

produces significant cross-over distortion as the output swings past zero volts. The distortion can be eliminated by suitably biasing Q1 and Q2; in which case, the circuit can form the basis of a good hi-fi amplifier.

Adders and subtractors

Figure 14 shows a unity-gain DC-voltage adder, which gives an inverted

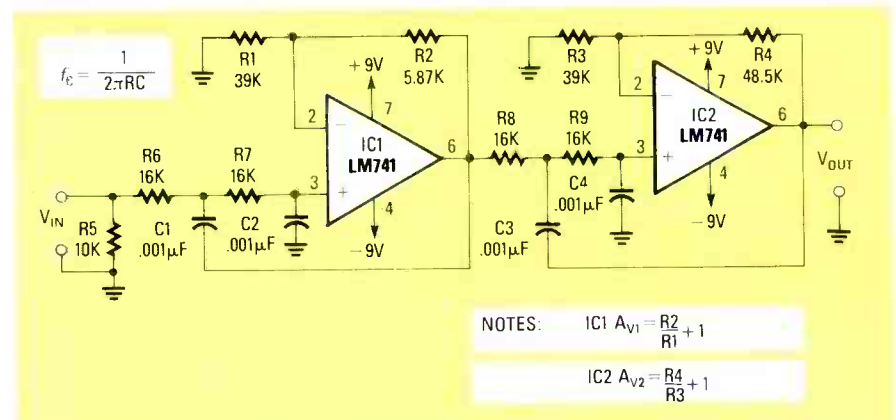

FIG. 21—4TH-ORDER 10-KHZ low-pass filter.

output voltage equal to the sum of the three input voltages. The current flowing in $R4$ is equal to the sum of the currents in $R1$ through $R3$. If required, the circuit can be made to give a voltage gain greater than unity by simply increasing the value of feedback resistor $R4$. Figure 15 is a 4-input audio mixer using AC input-coupling capacitors.

Figure 16 shows a unity-gain DC differential amplifier, also called a subtractor, where the output equals the difference between the two input-

signal voltages; if the component values are chosen such that $R2 = R4$ and $R1 = R3$, then the voltage gain, A_V , equals $R2/R1$.

Balanced phase-splitter

A phase-splitter has two outputs that are identical in both amplitude and form, but one output is phase-shifted by 180 degrees relative to the other. Figure 17 shows a unity-gain DC phase splitter. Here, IC1 acts as a unity-gain non-inverting amplifier, while IC2 acts as a unity-gain inverting amplifier that provides the 180 degrees phase-shifted output.

Active filters

Filter circuits are used to reject unwanted frequencies while passing frequencies that the designer wants. The low-pass RC filter in Fig. 18-a, passes low-frequency signals, but rejects high-frequency signals. Once the output falls to 3 dB at a "break" or "cross-over" frequency, as Fig. 18-b shows, the output continues to rolloff at a rate of 6 dB/octave (20 dB/decade) as the frequency increases. For example, a 1-kHz low-pass filter gives 3-dB rejection at 1 kHz, 9-dB rejection at 2 kHz, and, roughly, a 15-dB rejection to a 4-kHz signal (or 20 dB

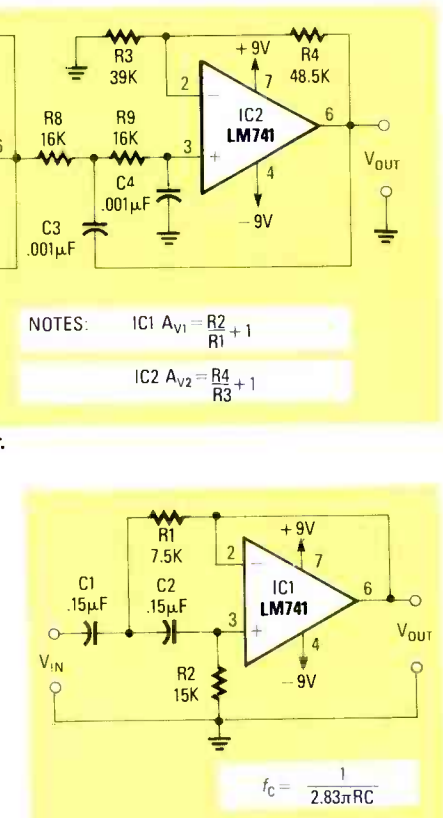
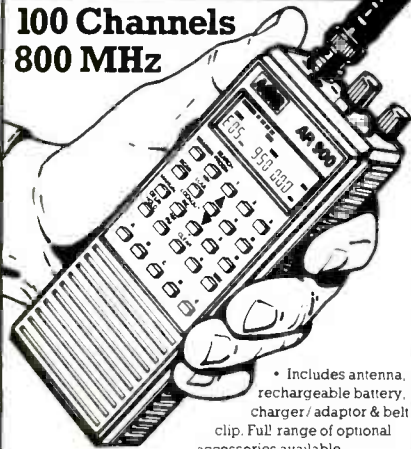

FIG. 22—2ND-ORDER 100-HZ HIGH-PASS unity-gain active filter.

New Scanner by AOR

**100 Channels
800 MHz**



- Includes antenna, rechargeable battery, charger/adaptor & belt clip. Full range of optional accessories available.

AR900

Total Price, Freight Prepaid
(Express Shipping Optional)

\$299.00

- Covers 27-54 MHz, 108-174 MHz, 406-512 MHz, and 830-950 MHz.
- 5 Scan Banks and 5 Search Banks.
- 25 Day Satisfaction Guarantee, Full Refund if not Satisfied.
- No Frequencies cut out.
- Size: 2" x 5 1/4" x 1 1/2" wt. 12 oz.

ACE

COMMUNICATIONS

10707 E. 106th St. Indpls., IN 46256

Toll Free 800-445-7717

Visa and MasterCard
(COD slightly higher)

In Indiana 317-849-2570 Collect FAX (317) 849-8794

CIRCLE 183 ON FREE INFORMATION CARD



CHEMICAL SOLUTIONS

FREE CHEMTRONICS CATALOG!

Comprehensive new source for over 200 products used in electronic manufacturing and field service. Precision cleaning agents, flux removers, bulk solvents, circuit refrigerants, precision dusters, non-residual wipers, foam swabs, premoistened pads/swabs, antistatic compounds, conformal coatings, lubricants, adhesives, desoldering braids, rosin core solder and solder masking agents. Complete with technical specifications and application guide.



Chemtronics Inc.
681 Old Willeys Path
Hauppauge, N.Y. 11788
516-582-3322

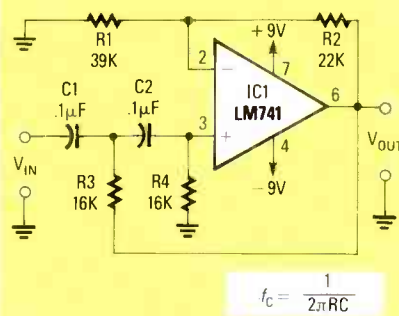

FIG. 23—2ND-ORDER 100-HZ HIGH-PASS equal-value-component active filter.

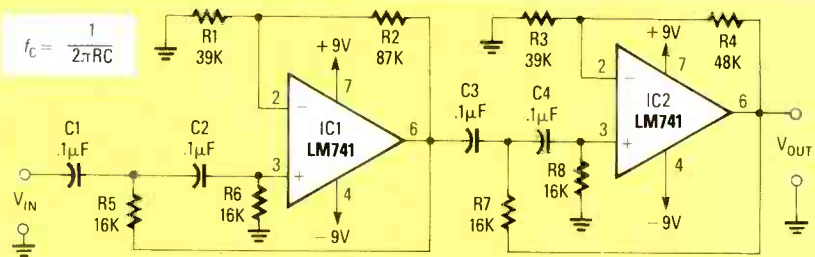

FIG. 24—4TH-ORDER 100-HZ HIGH-PASS FILTER.

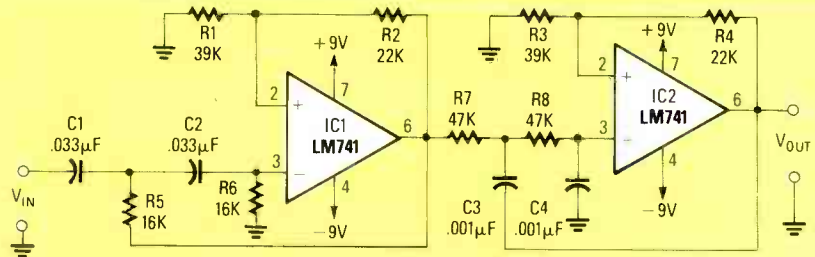

FIG. 25—300-HZ TO 3.4-KHZ SPEECH FILTER with 2nd-order response.

the feedback network of an op-amp making what are known as “active” filters. Let’s look at practical designs.

Figure 19 shows a Butterworth 2nd-order low-pass filter with a break frequency at 10 kHz. That design gives unity gain within its passband. To change the break frequency, simply change either the R or the C value. A major disadvantage of Fig. 19 is that the value of C2 must be precisely twice the value of C1 for correct operation and, in practice, that can result in some rather odd component values.

to a 10-kHz signal). Notice that the octave of 1 kHz is 2 kHz, and the octave of 2 kHz is 4 kHz; each octave causes an added attenuation of 6 dB.

The high-pass RC filter in Fig. 18-c, passes high-frequency signals but rejects low-frequency signals. After the output is 3-dB down at a break frequency, as Fig. 18-d shows, the output continues to roll-off at a rate of 6 dB/octave.

Each of the two filter circuits uses a single RC stage, and is known as the “1st order” filter. If we cascade “n” filter stages, it would be known as an “nth order” filter, and would have an output slope beyond the break frequency of (n × 6 dB)/octave.

Unfortunately, simple RC filters cannot be simply cascaded, because each filter section would interact with each other, resulting in poor performance. All of that can be overcome by incorporating the same filter into

Figure 20 shows an alternative 2nd-order 10-kHz low-pass filter, which overcomes that design snag by using equal capacitor values. Notice here that the op-amp is designed to give a voltage gain (4 dB) via R2 and R1.

Figure 21 shows how equal-value-component filters can be cascaded to make a 4th-order low-pass filter with a slope of 24 dB/octave.

Figures 22 and 23 shows a unity-gain and equal-value component versions, respectively, of 2nd-order 100-Hz high-pass filters. Figure 24 shows a 4th-order 100-Hz high-pass filter. The operating frequency can be changed by increasing either the resistor or capacitor values to reduce the break frequency. Finally, Fig. 25 shows how a high-pass and low-pass filter can be wired in series to make a 300-Hz to 3.4-kHz speech filter that gives 12-dB/octave rejection to all signals outside of that range. **R-E**

PC SERVICE

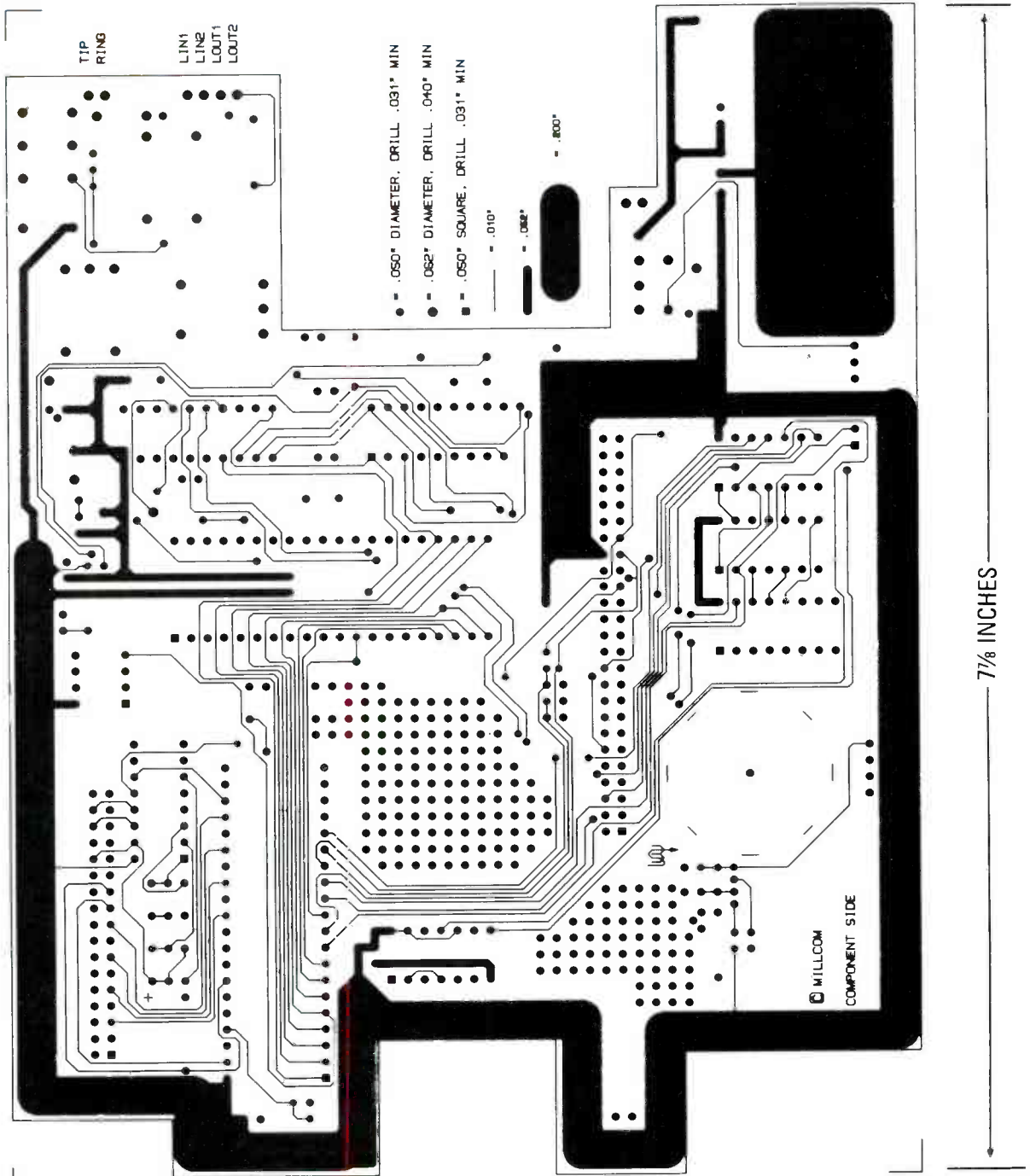

THE PROTOTYPING TELEPHONE's component side.

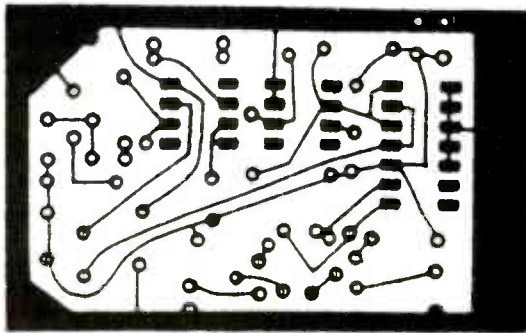

2 3/4 INCHES

THE IR EXTENDER foil pattern.

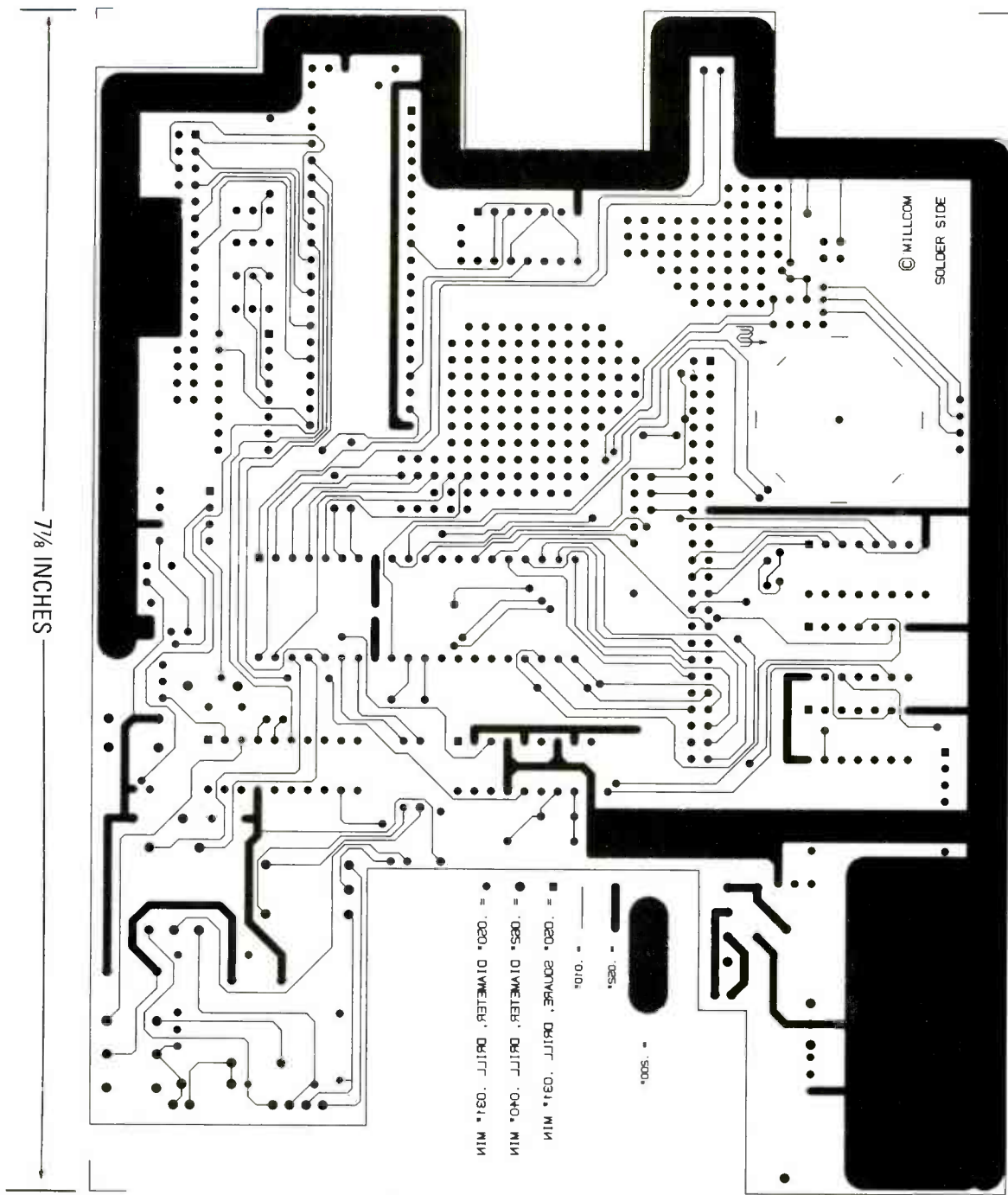

THE PROTOTYPING TELEPHONE's foil side.

HARDWARE HACKER

SAW devices
Phase plane plots
State variable filters
Call progress detectors
Low frequency resources

Phase-plane plots

WE SEEM TO BE MOVING ONCE AGAIN into a second new golden age of hardware hacking, as more and more people are discovering that there is an incredible variety of new and easy-to-use hardware goodies out there. It's also getting rather painfully obvious that the hardware and software have to work together in this day and age, rather than stand alone.

As you probably know by now, the staff at **Radio-Electronics** has resurrected the original **Popular Electronics**, and they fully intend to revive both the spirit and intent of the original.

Besides us, and our *Modern Electronics* competitors down the street, and all of those various ham-radio and CB magazines, you'll find three new and important hardware-hacking resources. Steve Ciarcia is going great guns with his new *Circuit Cellar Ink* magazine. *Heathkit* has a major new hobbyist magazine in the works. And, *Nuts and Volts* is a little high-energy shopper aimed squarely at hardware hacking.

While I have mentioned this a time or two before, no serious hardware hacker can afford to ignore any of the electronics trade journals, including *EDN*, *Electronic Design*, *Electronic Products*, *EE Times*, and *Electronic Components News*. As usual, you'll find a complete listing of all of the popular trade journals in *Uhrlichts Periodicals Dictionary* found on their reference shelf at your local library.

Once again, this is your column and you can get technical help and off-the-wall networking per the

Need Help? box. Your best calling times are 8–5 weekdays, *Mountain Standard Time*. As per usual, I have gathered most of the *Names and Numbers* together into one sidebar. Contact those people directly for more information.

This month, we have a mixed bag of off-the-wall topics. Let's start off with some...

Call-progress detectors

How can an electronic circuit tell if a phone call ever gets successfully completed? That is very important for fax machines, for security and alarm devices, auto-dialers, unattended BBS communications, and anyplace else that you want some electronics to be able to complete a call without any outside help.

Identifying just what is happening when goes by the name of *call-progress detection*, and the single-chip integrated circuits that handle that are called *call-progress detectors*.

Three leading manufacturers of the call-progress detector chips include *Teltone*, *Signetics*, and those *Silicon Systems* folks. We will use the chips from *Silicon Systems* here.

Call progress gets measured by

NEED HELP?

Phone or write your **Hardware Hacker** questions directly to:
Don Lancaster
Synergetics
Box 809
Thatcher, AZ 85552
(602) 428-4073

the presence of one or more *supervisory signals* on the phone line. There is the *dial tone* that tells you that the line is ready to use, the *busy signal* that tells you a call can not be completed, the *ringback* that simulates the sound of the phone at the other end ringing, and finally, an obscure *reorder* signal that tells you the call only went halfway through and has to be repeated.

Two methods of detecting a call-progress signal are by the *frequency* and their *cadence*. For the most reliable detection, both of those should be used together.

Figure 1 shows you all the standards for those *new or precise* call-progress signals. They will work for most people most of the time. The dial tone is a continuous mix of 350- and 440-Hz sine waves. The busy signal is a gated mix of 480 and 620 Hz, with the cadence of half a second on and half a second off.

The ringback is a gated mix of 440- and 480-Hz sine waves, having a cadence of two seconds on and four seconds off. Finally, that odd reorder signal is a gated mix of 480-Hz and 620-Hz signals, with a cadence of 0.3 seconds on and 0.2 seconds off.

Figure 2 shows you a typical circuit that uses the 75T982 Call-Progress Detector. The phone line is capacitance-coupled to the input. The sensitivity can be increased by ten decibels by using the XRANG input as shown. Clocking is by way of a built-in oscillator using a low-cost color-TV crystal. There are four separate output lines for dial tone, ringing, busy, and reorder.

There is a separate *strobe* output on pin 13 that tells you if any output is active.

There is an older and simpler chip known as the 75T980 that works with both old and new call-progress tones. However, its detection is not nearly as reliable, and an external cadence measurement must be made to sort out the progress commands.

Pricing is around \$7 for the 980 and \$12 for the 982 in small hacker quantities. For additional details, see the *Communications Products* data book from *Silicon Systems*.

Low-frequency resources

There are all sorts of interesting things going on in those low radio frequencies below the AM broadcast band. Look closely, and you will find time and frequency standards, precise navigation systems, communications devices for cave rescue and for mine safety, metal locators, treasure finders, and bunches of other interesting and oddball stuff.

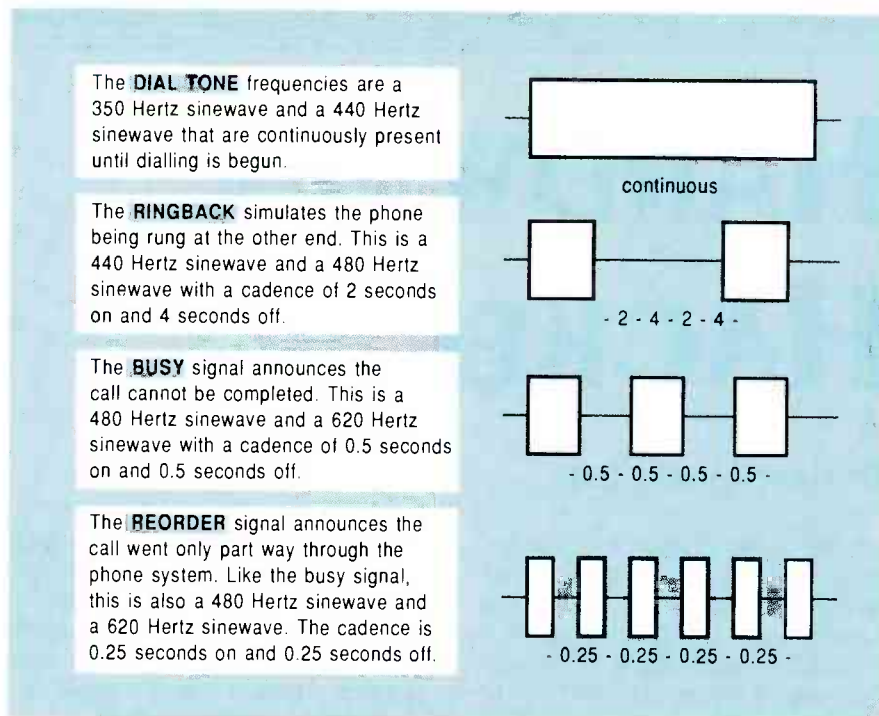

FIG. 1—TELEPHONE CALL-PROGRESS signals can be detected by both their frequency and their cadence. Here are the US standards for the “precise” or “new” call-progress tones. They are now in use nearly everywhere.

NEW FROM DON LANCASTER

HANDS-ON BOOKS

| | |
|---------------------------------|-------|
| Hardware Hacker Reprints II | 24.50 |
| Ask The Guru Reprints I or II | 24.50 |
| CMOS Cookbook | 18.50 |
| TTL Cookbook | 16.50 |
| Active Filter Cookbook | 15.50 |
| Micro Cookbook vol I or II | 16.50 |
| Enhancing your Apple I or II | 17.50 |
| AppleWriter Cookbook | 19.50 |
| Apple Assembly Cookbook | 21.50 |
| Incredible Secret Money Machine | 10.50 |
| LaserWriter Reference (Apple) | 19.50 |
| PostScript Cookbook (Adobe) | 16.50 |
| PostScript Ref. Man. (Adobe) | 22.50 |
| PostScript Prog. Design (Adobe) | 22.50 |

UNLOCKED SOFTWARE

| | |
|-------------------------------------|-------|
| PostScript Show & Tell (Ile/Mac/PC) | 39.50 |
| Intro to PostScript VHS Video | 39.50 |
| PostScript Perspective Draw | 39.50 |
| PostScript Printed Circuits | 39.50 |
| PostScript Technical Illustrations | 39.50 |
| PostScript Work in Progress | 39.50 |
| PostScript BBS stuff | 19.50 |
| Absolute Reset Ile & Iic | 19.50 |
| AppleWriter/Laserwriter Utilities | 49.50 |
| Enhance I or II Companion Disk | 19.50 |
| AppleWriter CB or Assy CB Disk | 24.50 |

FREE VOICE HELPLINE VISA/MC

SYNERGETICS
 Box 809-RE
 Thatcher, AZ 85552
 (602) 428-4073

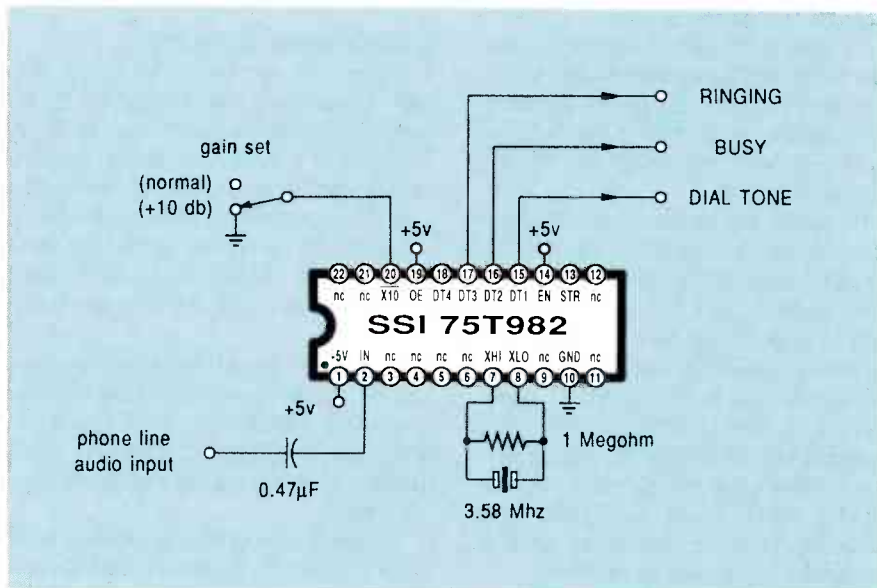

FIG. 2—A CIRCUIT TO DETECT the “new” or “precise” call-progress signals. This is a Silicon Systems chip; similar ones are available from Signetics or Teltone.

As you might suspect, there are some great little newsletters out there that support any hackers with strong interests in low-frequency communications. Figure 3 gives you a list of the “top five” of those resources.

Of those, far and away my favorite is *Speleonic*, and many thanks to their editor and publisher Frank Reid, for putting me on to the others.

And hey! Those are all volun-

teer, labor-of-love nanobudget setups. So, either subscribe outright or else send them a buck and a SASE with any of your inquiries.

SAW devices

There sure seems to be a lot of hacker interest in the SAW, or Surface Acoustical Wave devices. Sadly, all of them are usually custom devices offered only in large quantities. Only rarely will useful devices show up on the sur-

MASTER THE NEW ELECTRONICS WITH MCGRAW-HILL'S

Contemporary Electronics Series

The fast, easy and low cost way to meet the challenges of today's electronic innovations. A unique learning series that's as innovative as the circuitry it explains, as fascinating as the experiments you build and explore.

From digital logic to the latest 32-bit microprocessor, the McGraw-Hill Contemporary Electronics Series puts you into the electronic picture one easy step at a time. Fifteen unique Concept Modules, sent to you one every 4-6 weeks, give you a handle on subjects like optoelectronics, robotics, integrated circuits, lasers, fiber optics and more.

Each Concept Module goes right to the heart of the matter. You waste no time on extraneous material or outdated history. It's a fast, efficient, and lively learning experience... a non-traditional approach to the most modern of subject matter.

Unique Interactive Instruction

With each module, you receive a McGraw-Hill Action Audio Cassette. Each tape is a dynamic discussion that drives home the key facts about the subject. Your learning

With your first module, you get this solderless breadboarding system. You'll use it throughout the series to build electronic circuits and bring concepts to life.

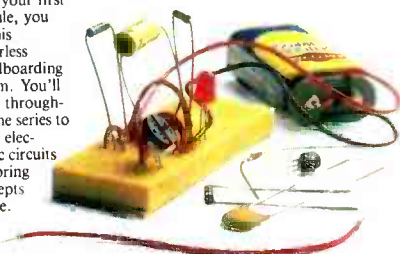

experience is reinforced through interaction with vividly illustrated text, audio cassettes, and actual electronic experiments. Indexed binders preserve backup material, notes, and tapes for convenient referral.

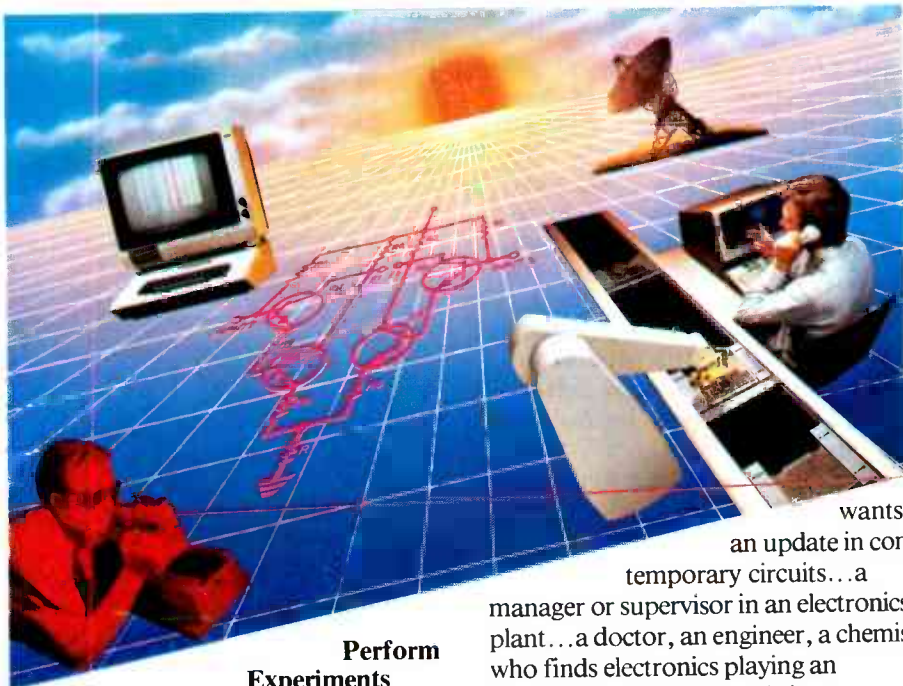

Perform Experiments in Contemporary Electronics

Throughout your series, laboratory experiments reinforce every significant point. This essential experience... dynamic, hands-on demonstrations of theory in practice... will help you master principles that apply all the way up to tomorrow's latest VLSI (Very Large Scale Integrated) circuitry.

In your very first module, you'll use integrated circuits to build a digital oscillator, verifying its operation with a light emitting diode (LED). You'll learn to identify passive and active components, understand concepts common to all electronic circuits.

For Anyone Interested in Electronics

The Contemporary Electronics Series is designed for anyone from hobbyist to professional. It's for you if you're looking for new fields of interest... if you're a teacher who

wants an update in contemporary circuits... a manager or supervisor in an electronics plant... a doctor, an engineer, a chemist who finds electronics playing an increasingly important role in your work. It's even for electronics engineers or technicians who feel their training needs freshening up. It's the quickest, most convenient, probably least expensive way to do it. And the only one that gives you hands-on experience.

15-Day No-Risk Trial

To order your first module without risk, send the card today. Examine it for 15 days under the terms of the order form and see how the Contemporary Electronics Series gets you into today's electronics. If card has been used, write us for ordering information.

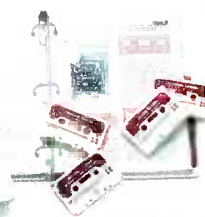

McGraw-Hill
Continuing Education Center
3939 Wisconsin Ave.
Washington, D.C. 20016

plus market. And it does take some smarts to properly apply them.

At any rate, a SAW device consists of a transmitting transducer mounted upon a suitable substrate. That transmitter will create a surface wave that can travel across the device over to the receiver. By carefully controlling the layout pattern of the transmitter and the receiver, you can create a fancy filter, a delay equalizer, or a sophisticated radar signal processor.

The SAW devices are very popular for television and for cable-system filtering, since they can give a fancy response curve in a very small package at low cost. Most important of all, they do not require any alignment, calibration, or adjustment to get or keep the desired response.

SAW filters are inherently lossy. Some are offered with built-in amplifiers and impedance matchers, while others are nothing but the SAW device itself.

A typical SAW device might get used as a 44-MHz filter that can go between the television tuner and its intermediate frequency signal processing. Another use is for the vestigial sideband filters used by some cable television and satellite systems.

One quantity source of low-cost SAW devices is *Plessey Signal Technologies*. All of their models SW302, SW303, and SW304 are typical channel-2, channel-3, and channel-4 vestigial sideband filters which sell for around \$2.50 in thousand lots.

Plessey's minimum order is 500 identical pieces. I know of no retail or low-volume source, except as the catch-as-catch-can surplus in such places as *Nuts and Volts*. Do let me know if you find any.

An active filter

Active filters form a class of electronic devices that use operational amplifiers, resistors, and capacitors to replace all the cumbersome, lossy, and expensive inductors needed in all the traditional filters. Active filters will now compete against switched-capacitor integrated filters and digital signal-processing techniques, so their use has pretty much peaked, es-

NAMES AND NUMBERS

Circuit Cellar Ink
4 Park Street, Suite 20
Vernon, CT 06066
(203) 875-2751

Computer Shopper
Box F
Titusville FL 32781
(407) 269-3211

Heath Company
PO Box 217
Benton Harbor, MI 49022
(616) 982-3200

Hewlett-Packard
PO Box 10301
Palo Alto, CA 94303
(415) 857-1501

MicroCAD News
12710 Research, Suite 250
Austin, TX 78759
(512) 250-1700

Nuts & Volts
PO Box 1111
Placentia, CA 92670
(714) 632-7721

Plastock/Plastimatic
Three Oak Road
Fairfield, NJ 07006
(201) 575-0038

Plessey/Signal Technology
9630 Ridgehaven Court
San Diego, CA 92123
(619) 571-7715

Popular Electronics
500-B Bi-County Blvd.
Farmingdale, NY 11735
(516) 293-3000

Porex Technologies
500 Bohannon Road
Fairburn, GA 30213
(800) 241-0195

Radio-Electronics
500-B Bi-County Blvd.
Farmingdale, NY 11735
(516) 293-3000

Signetics
811 E Arques Avenue
Sunnyvale, CA 94088
(408) 991-2000

Silicon Systems
14351 Myford Road
Tustin, CA 92680
(714) 731-7110

Supertex
1225 Bordeaux Drive
Sunnyvale, CA 94088
(408) 744-0100

Surplus Center
1015 West "O" Street
Lincoln, NE 68501
(800) 228-3407

Surplus Traders
Winters Lane, Box 276
Alburg, VT 05440
(514) 739-9328

Teledyne Semiconductor
1300 Terra Bella Avenue
Mountain View, CA 94039
(415) 968-9241

Teltone
10801 120th Avenue NE
Kirkland, WA 98033
(206) 827-9626

LOW FREQUENCY RESOURCES

Low Down
Longwave Club of America
45 Wildflower Road
Levittown, PA 19057
\$12 per year

1750 Meters Update
% Jim Ericson
226 Charles Street
Sunnyvale, CA 94086
(408) 773-8947
\$10 per year

Speleonics
% Frank Reid
PO Box 5283
Bloomington, IN 47407
(812) 339-7305
\$4 per year

Northern Observer
% Herb Balfour
91 Elgin Mills Road West
Richmond Hill, Ontario
CANADA L4C 4M1
(416) 884-5355
\$12 per year

BCRA Radio Group
% Phil Ingham
49 Highfield Road
Farnworth Bolton
ENGLAND BL4 0AH
(0204) 791918
\$10 per year

FIG. 3—THE LOW RADIO FREQUENCIES below the broadcast band support all sorts of interesting time and frequency services, navigation aides, cave rescue, mine safety, metal location, and treasure-finding services. Here are the main hacker low-frequency newsletters.

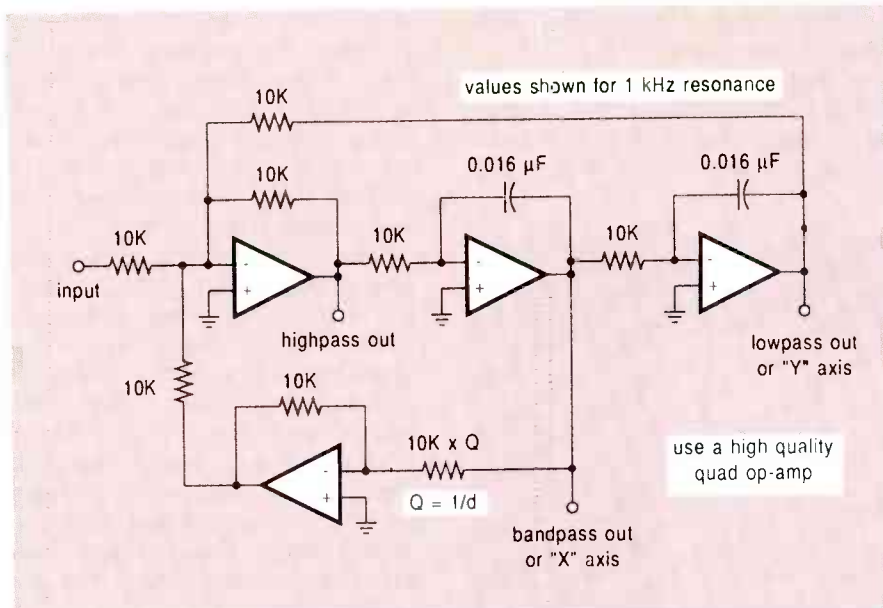

FIG. 4—THIS STATE-VARIABLE ACTIVE FILTER provides lowpass, bandpass, and high-pass outputs, and is a good “workhorse” circuit for both low- and high-Q uses. This is also a handy test circuit for exploring phase-plane plots.

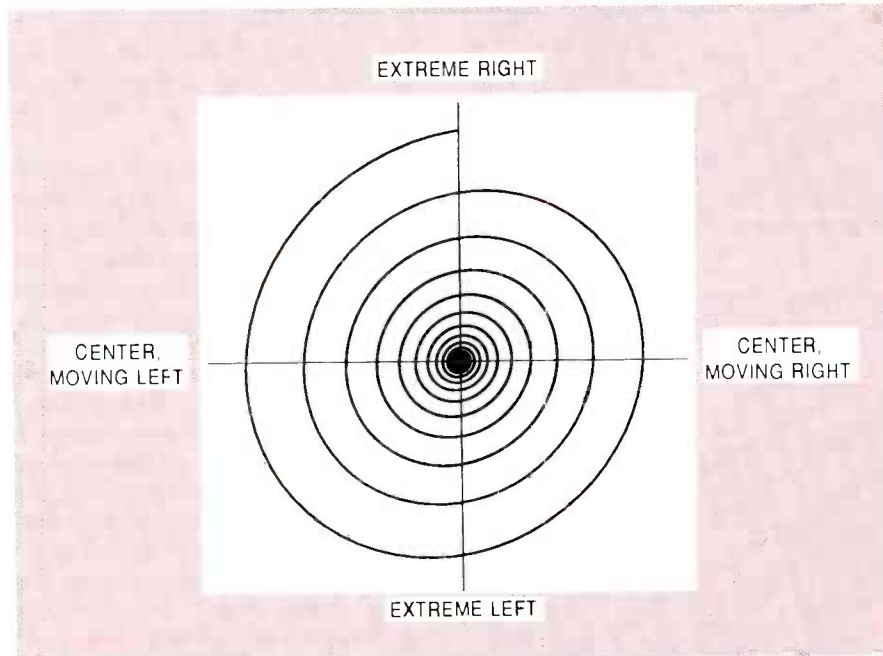

FIG. 5—THE PHASE-PLANE PLOT of a damped pendulum. Phase-plane plots have important uses in response curves, system stability, chaos theory, and for many unusual artistic effects. Note that time is a parameter that advances inward along the path of the phase-plane plot.

pecially at high signal levels.

You’ll find lots of hands-on active-filter design details inside my *Active Filter Cookbook*. Let us look at a typical “workhorse” active-filter circuit that has a high “Q,” high stability, a minimum interaction, and easy tuning. It is known as a state-variable filter, and simultaneously could give you low-pass, band-pass, and high-pass output pins.

Figure 4 is an example of 1-kHz

state-variable active filter that uses a quad op-amp to produce a single low-to-high “Q” pole in the audio range. You adjust your frequency range by changing either the resistors or the capacitors, keeping their ratios constant. The “Q” gets adjusted with the resistor as shown. Usually, several of those circuits are cascaded to make a fancier overall response function. Full details appear in the book.

I’m showing you this circuit

here, because we will need to use it just as soon as we start talking about...

Phase-plane plots

Every now and then, some idea will just sit there, quietly blorking away on the back burners of hackers everywhere, until the time gets ripe to do new and exciting things with it. Let’s take a look at one of the oldest of hardware-hacker concepts, and see where it is going today and in which direction we can try and shove it in the future. For fun or cash.

I am talking about *phase-plane plots*, an extremely old graphic technique that today can be extended into some stunning new art forms, as well as be used to create all sorts of new-age toys and gadgetry.

A phase-plane plot is simply a two- or three-dimensional plot of the amplitude versus the phase angle of some value of some physical or abstract system. Time is a parameter that goes *along* the curve. As one example, say we gave a damped pendulum a shove and then plotted its phase angle versus time. We would get the spiral phase-plane plot of Fig. 5.

We get a spiral because of the damping. The greater the damping, the faster the swings will die away and the sooner the pendulum will come to rest. Should we have zero damping (or infinite “Q”), we would have an oscillator whose phase plane was a continuous circle. Should the system receive some energy from an outside source, we might even end up with *negative damping*, and the spiral would expand toward infinity, rather than contract. At some point, however, we will come up against some physical constraint of the system and somehow box ourselves in. Or else self-destruct.

By the way, the apparent distortion in Fig. 5 is quite real. Your eye is expecting circles, and the motion toward the center seems to squash things slightly. That will get far more obvious as the damping goes up.

One of the oldest of the phase-plane plots is called the *Lissajous* figure. Back in the days when oscilloscopes did not have any de-

cent time bases in them, you measured frequency by inputting an unknown frequency on the x axis and a known one on the y axis. Any time the two frequencies would be some exact fractional

which are related in frequency by a factor of precisely 3:2.

Note that we are plotting an "X" amplitude against a "Y" amplitude, and that time that moves along the curve. That is what

of servo-mechanisms and power systems. An exciting new study area of the phase-plane plots involves *chaos theory*. The phase-plane plots can reveal areas where a physical system will behave rationally and other areas where it will behave chaotically.

One of the most famous of chaotic phase-plane plots is called the *Lorenz Attractor*, otherwise known as the "owl's mask." A good starting point to explore that fascinating subject is *Chaos: Making a New Science* by James Gleick. There is a very distinct possibility that such chaotic things as weather and stock-market prices are ultimately controlled by those strange attractors. And that gets heavy fast.

I guess I first really got into phase-plane plots back when I was writing my *Active Filter Cookbook*. We had built the circuit of Fig. 4, and inadvertently connected the real and quadrature outputs to the "X" and "Y" inputs of a scope.

We input some music and then the whole engineering department sat fascinated for hours staring at those wondrous and beautiful waveforms. Things got even more interesting when we substituted a low-frequency function generator for all the music, which gave you several stunningly artistic patterned objects. Many of them appeared in chapter ten of my *Active Filter Cookbook*. I called those waveforms *quadrature art*.

I invite you to take the circuit in Fig. 3, hook it up to a scope, and input some music or a function generator and see what you come up with. At the time I did that, visions of exciting newer color-organ and psychedelic-lighting toys danced through my head. Reality struck when I realized that the oscilloscope was essential at that time. And not enough hackers had scopes to bother with.

But today we have low-cost oscilloscopes. We have color computers everywhere. We have plotters and high-resolution printers. We have cameras and VCR's. And, above all, we have that incredible new *PostScript* graphics language that I am so keen on. We also now can use imaginary, rather than all

continued on page 76

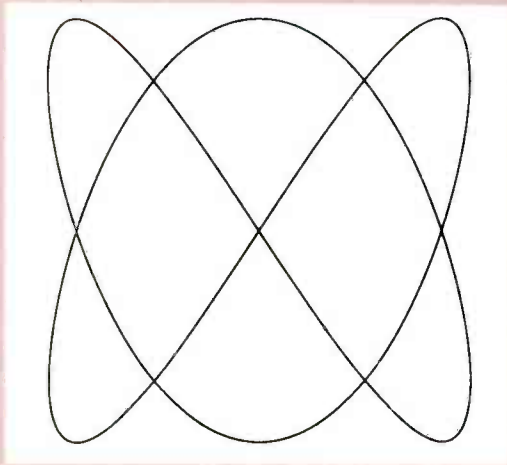

FIG. 6—THE LISSAJOUS FIGURE is the oldest of phase-plane plots. The two sine-wave frequencies shown here are in a ratio of 3:2.

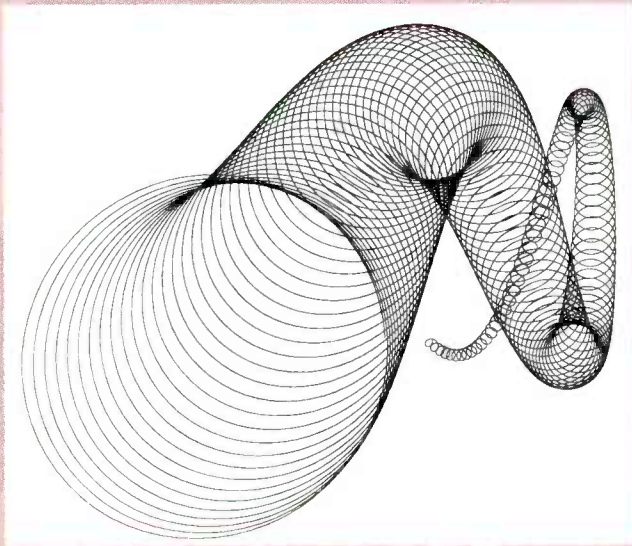

FIG. 7—A TOTALLY FICTITIOUS phase-plane plot simulated by using the PostScript page-description language. Similar results can be achieved with almost any language on almost any personal computer.

multiple of each other, you would get a stationary pattern on the screen. Figure 6 shows you a Lissajous figure of two sine waves

phase-plane plots are all about.

Yes, there are many serious uses of phase-plane plots. Some of them involve the system stability

Radio-Electronics mini-ADS

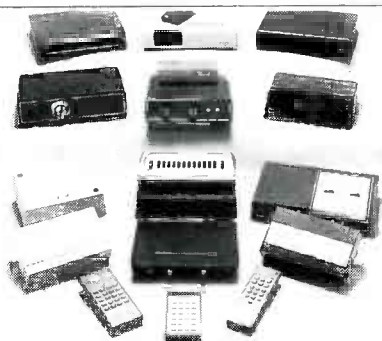

CABLE TV CONVERTERS AND DE-SCRAMBLERS SB-3 \$79.00 TRI-BI \$95.00 MLD-\$85.00 M35B \$89.00 JRX-DIC \$129.00 Special combos available. We ship COD. Quantity discounts. Call for pricing on other products. Dealers wanted. FREE CATALOG. We stand behind our products where others fail. One year warranty. **ACE PRODUCTS, P.O. Box 582, Saco, ME 04072 (207) 967-0726.**

CIRCLE 75 ON FREE INFORMATION CARD



THE MODEL WTT-20 IS ONLY THE SIZE OF A DIME, yet transmits both sides of a telephone conversation to any FM radio with crystal clarity. Telephone line powered - never needs a battery! Up to 1/4 mile range. Adjustable from 70-130 MHZ. Complete kit \$29.95 + \$1.50 S+H. Free Shipping on 2 or more! COD add \$4. Call or send VISA, MC, MO. **DECO INDUSTRIES, Box 607, Bedford Hills, NY 10507. (914) 232-3878.**

CIRCLE 127 ON FREE INFORMATION CARD



FREE CATALOG OF HARD-TO-FIND TOOLS is packed with more than 2000 quality items. Your single source for precision tools used by electronic technicians, engineers, instrument mechanics, schools, laboratories and government agencies. Also contains Jensen's line of more than 40 tool kits. Send for your free copy today! **JENSEN TOOLS INC., 7815 46th St., Phoenix, AZ 85044. (602) 968-6231.**

CIRCLE 115 ON FREE INFORMATION CARD

CALL NOW AND RESERVE YOUR SPACE

- 6 x rate \$890.00 per each insertion.
- Fast reader service cycle.
- Short lead time for the placement of ads.
- We typeset and layout the ad at no additional charge.

Call 516-293-3000 to reserve space. Ask for Arline Fishman. Limited number of pages available. Mail materials to: mini-ADS, RADIO-ELECTRONICS, 500-B Bi-County Blvd., Farmingdale, NY 11735. FAX: 516-293-3115.



APPLIANCE REPAIR HANDBOOKS—13 volumes by service experts; easy-to-understand diagrams, illustrations. For major appliances (air conditioners, refrigerators, washers, dryers, microwaves, etc.), elec. housewares, personal-care appliances. Basics of solid state, setting up shop, test instruments. \$2.65 to \$7.90 each. Free brochure. **APPLIANCE SERVICE, P.O. Box 789, Lombard, IL 60148. (312) 932-9550.**

CIRCLE 84 ON FREE INFORMATION CARD



SM-333 Surround Sound Processor for ultimate realism. Features VCR, Video Disc and CD selectable inputs. Can be used with tuners, tape desks and LP discs. Has front panel controlled DYNAMIC NOISE REDUCTION, level, effect and delay. Outputs for front and rear stereo speaker amplifiers. **COMPLETE KIT \$62.00 Assembled & Tested \$83.00 + 10% S+H.** Call or send VISA, MC, AMEX, MO, CK. **MARK V ELECTRONICS, NC, 8019 E. Slauson Ave., Montebello, CA 90640. (213) 888-8988 FAX (213) 888-6868.**

CIRCLE 93 ON FREE INFORMATION CARD

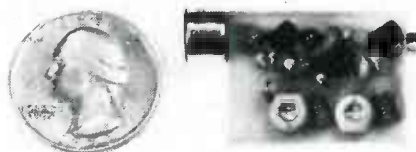

SIMPLY SNAP THE WAT-50 MINIATURE FM TRANSMITTER on top of a 9v battery and hear every sound in an entire house up to 1 mile away! Adjustable from 70-130 MHZ. Use with any FM radio. Complete kit \$29.95 + \$1.50 S+H. Free shipping on 2 or more! COD add \$4. Call or send VISA, MC, MO. **DECO INDUSTRIES, Box 607, Bedford Hills, NY 10507. (914) 232-3878.**

CIRCLE 127 ON FREE INFORMATION CARD

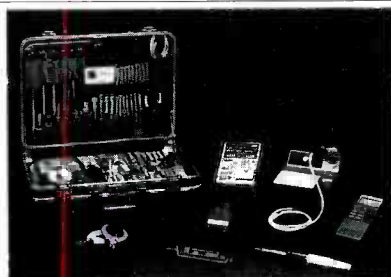

QUALITY FIELD SERVICE KITS and test equipment, production aids, telecommunications and voice/data equipment, maintenance and repair tools, work station and static control products can be found in the Time Motion Tools catalog. All Time Motion Tools products carry our guarantee of complete satisfaction, or your money back within 30 days. For a FREE CATALOG write: **TIME MOTION TOOLS, 410 S. Douglas Street, El Segundo, CA 90245. (213) 772-8170.**

CIRCLE 182 ON FREE INFORMATION CARD



PASSIVE INFRARED DETECTOR • Used in alarm system, moving detection • Super sensitive • Exchangeable lens • Very reliable • Analog Pulse Count • RK4000PCA \$59.— Digital Voice Module • Low cost • Super quality • Selectable banks • 1 W amp • 4 sampling rates • DRAM operation • DVM-1 \$49.— (without RAM). **MING ENGINEERING, 515 S. Palm Ave., #5 Alhambra, CA 91803. (818) 570-0058.**

CIRCLE 186 ON FREE INFORMATION CARD

AUDIO UPDATE

The history and theory of the dynamic loudspeaker



LARRY KLEIN,
AUDIO EDITOR

ONCE UPON A TIME, MUSIC WAS ALWAYS a "live" experience. Prior to Edison's invention of the phonograph in 1877, there was simply no way to store live sound and reproduce it on demand. Edison's first model used a short mouthpiece horn that terminated in a flexible diaphragm bearing a metal stylus. The free end of the stylus rested on the foil-clad surface of a hand-cranked cylinder. Sounds of sufficient loudness would vibrate the diaphragm, causing the stylus to emboss a track on the rotating foil surface. Playback involved a reversal of the process: The track in the foil would vibrate the stylus and its attached diaphragm and thereby roughly—very roughly—recreate the original sound. In truth, Edison's phonograph was simple enough that it could easily have been invented by the ancient Greeks more than two thousand years earlier. In any case, the history of the loudspeaker can be considered as starting in 1877. All subsequent developments essentially reflect the attempt to make it play louder and more accurately.

Early history

I suspect that one of the reasons for Enrico Caruso's popularity as a recording artist was his ability to provide the enormous amounts of acoustic power needed for the "direct-to-disc"—or "direct-to-cylinder"—recordings of his day. Until electricity got into the act, recordings were made by clustering all the performers around a single,

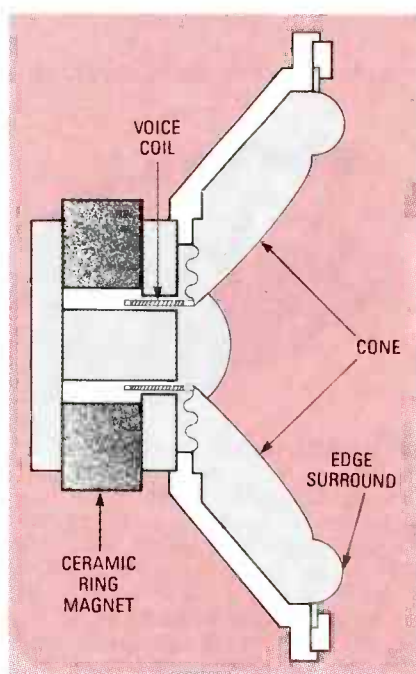

FIG. 1

huge recording horn and urging them to play or sing as loudly as possible. During playback, the efforts to make the acoustic phonograph louder and more accurate were limited to improving the mechanical pickup head and enlarging its acoustic horn.

In the early 1920's, the recording industry was economically jolted by a startling new invention—radio. The annual profits of the Victor Talking Machine Company plummeted from a high of about \$23 million to a low of \$123,000. However, the good news was that the same technology (electronics) that made radio possible was soon applied to the recording process,

with enormous success. Primitive microphones feeding equally primitive vacuum tubes driving electro-magnetic disc cutters achieved a remarkable improvement in recorded fidelity. Unfortunately, the phonophiles of the day had no choice but to play their new "electrical" recordings on purely acoustic phonographs—but that was also about to change.

In the 1920's, radios usually had separate speakers, whose trumpet-like horns emerged from a base that housed a driven stiff-metal diaphragm not unlike those found in the telephone receivers of the day. But a number of researchers were addressing themselves to the dual problems of volume and fidelity. The breakthrough came about in 1925, spearheaded by the work of two General Electric engineers, Chester Rice and Edward Kellogg.

The moving-coil speaker

Rice and Kellogg's description of their work, "Notes on the Development of a New Type of Hornless Loud Speaker," appeared in April 1925 in a leading technical journal. More important, their exposition was shortly backed up by commercial products that were audibly so much better than anything previously available that, within a few years, virtually all other designs were driven from the marketplace. And now, 63 years later, the moving-coil direct-radiator woofer, midranges, and tweeters found in 95% of to-

continued on page 76

Find The Defective Capacitors, Coils, Resistors, SCRs And Triacs That All Other Testers Miss . . .

Presenting a new, improved, dynamic mistake proof LC Analyzer that finds defective components all other testers miss.

Dynamically tests capacitors for value from 1 pF to 20F, leakage with up to 1000 tests applied, dielectric absorption and equivalent series resistance (ESR).

Dynamically tests inductors, in-or-out of circuit, from 1 μ H to 20 Henrys for shorts, value, and detects even shorted turns.

• Dynamically tests SCRs, Triacs, High Value Resistors, and locates the distance to within feet of an open or short in a transmission line for an added bonus.

• Automatically makes all of the tests, compares them to EIA (Electronic Industries Association) standards and reads the results as Good or Bad. Enter all information right from the component without look-up charts, calculations, or errors.

• Extends your testing capability to places where an AC cord won't reach, with rechargeable 9 hour battery or AC operations.

• An added feature alerts you that the fuse has opened, and that there may be residual high voltage on the component under test.

New!
and Improved!



It's like having your own Standards Engineer with you all the time.

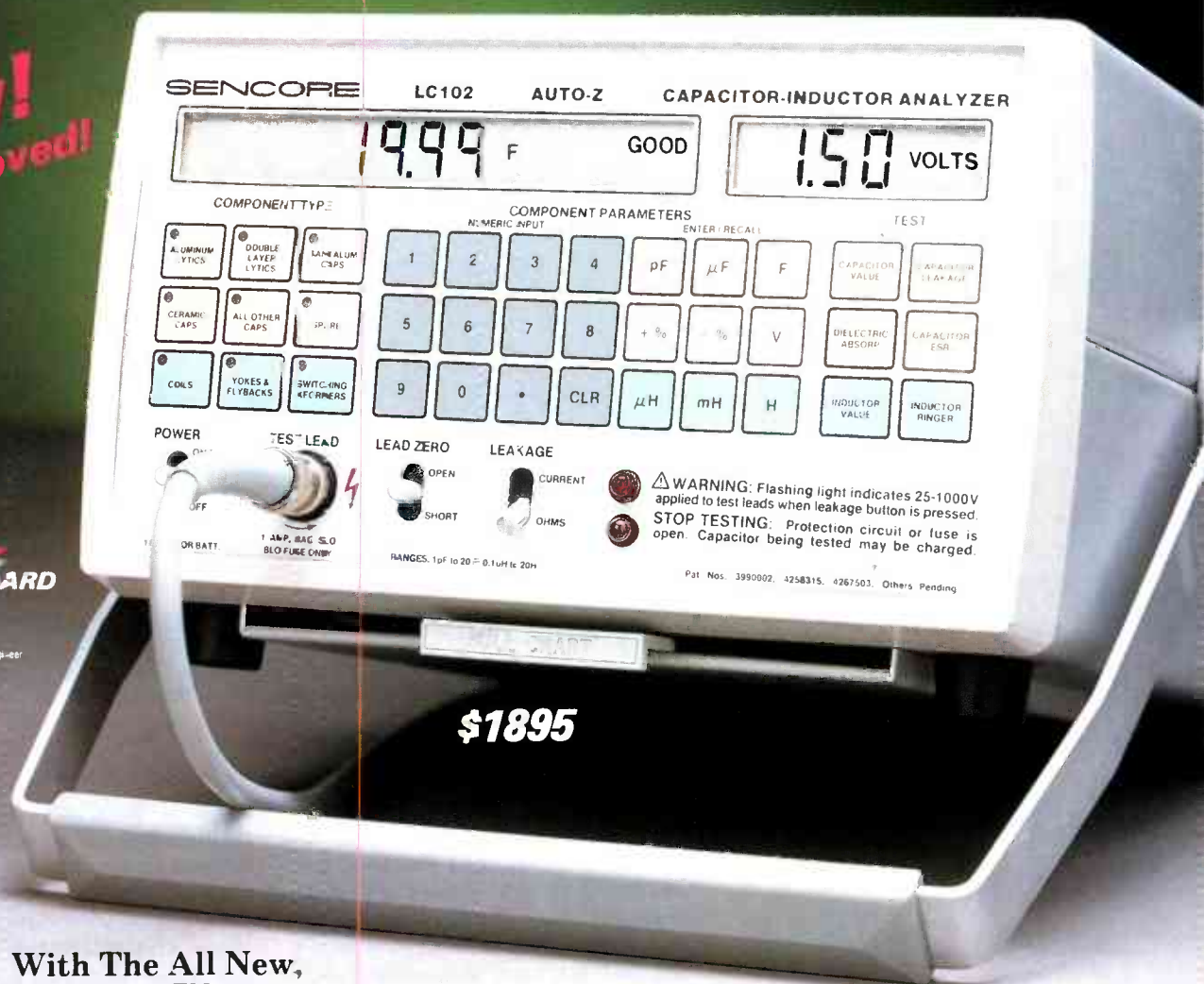

With The All New,
LC102 AUTO-Z™ Automatic
Capacitor-Inductor Analyzer.
Four Patents

Call 1-800-843-3338
In Canada Call 1-800-851-8866

DRAWING BOARD

Let's start programming!

ONE OF THE NICE THINGS ABOUT DESIGNING a character generator is that you get a chance to satisfy all



ROBERT GROSSBLATT,
CIRCUITS EDITOR

| EPROM CHARACTER GENERATOR CHART | | | | | | | | | | | |
|---------------------------------|----|------------------------|----|----|----|----|----|----|---------------|---------|---|
| INPUT | | PROGRAMMED OUTPUT DATA | | | | | | | | SEGMENT | |
| EPROM ADDRESS | D7 | D6 | D5 | D4 | D3 | D2 | D1 | D0 | HEX DATA BYTE | DISPLAY | |
| COMMON-ANODE DISPLAY | | | | | | | | | | | |
| HEX DIGITS | | | | | | | | | | | |
| 000 | 0 | 0 | 0 | 0 | 0 | 0 | 0 | 0 | 0 | 3F | 0 |
| 001 | 0 | 0 | 0 | 0 | 0 | 0 | 1 | 1 | 1 | 06 | 1 |
| 002 | 0 | 0 | 0 | 0 | 0 | 0 | 1 | 1 | 1 | 5B | 2 |
| 003 | 0 | 0 | 0 | 0 | 0 | 0 | 1 | 1 | 1 | 4F | 3 |
| 004 | 0 | 0 | 0 | 0 | 0 | 0 | 1 | 1 | 1 | 66 | 4 |
| 005 | 0 | 0 | 0 | 0 | 0 | 0 | 1 | 1 | 1 | 6D | 5 |
| 006 | 0 | 0 | 0 | 0 | 0 | 0 | 1 | 1 | 1 | 7D | 6 |
| 007 | 0 | 0 | 0 | 0 | 0 | 0 | 1 | 1 | 1 | 07 | 7 |
| 008 | 0 | 0 | 0 | 0 | 0 | 0 | 1 | 1 | 1 | 7F | 8 |
| 009 | 0 | 0 | 0 | 0 | 0 | 0 | 1 | 1 | 1 | 77 | 9 |
| 00A | 0 | 0 | 0 | 0 | 0 | 0 | 1 | 1 | 1 | 7C | a |
| 00B | 0 | 0 | 0 | 0 | 0 | 0 | 1 | 1 | 1 | 79 | b |
| 00C | 0 | 0 | 0 | 0 | 0 | 0 | 1 | 1 | 1 | 39 | c |
| 00D | 0 | 0 | 0 | 0 | 0 | 0 | 1 | 1 | 1 | 5E | d |
| 00E | 0 | 0 | 0 | 0 | 0 | 0 | 1 | 1 | 1 | 79 | e |
| 00F | 0 | 0 | 0 | 0 | 0 | 0 | 1 | 1 | 1 | 71 | f |
| ASCII CHARACTERS | | | | | | | | | | | |
| 041 | 1 | 1 | 1 | 1 | 0 | 1 | 1 | 1 | 1 | F7 | A |
| 042 | 1 | 1 | 1 | 1 | 1 | 0 | 1 | 1 | 1 | FC | B |
| 043 | 1 | 0 | 1 | 1 | 1 | 1 | 0 | 0 | 0 | 89 | C |
| 044 | 1 | 1 | 0 | 1 | 1 | 1 | 1 | 1 | 1 | DE | D |
| 045 | 1 | 1 | 1 | 1 | 1 | 1 | 0 | 0 | 1 | F9 | E |
| 046 | 1 | 1 | 1 | 1 | 1 | 0 | 0 | 0 | 1 | F3 | F |
| 047 | 1 | 1 | 1 | 0 | 0 | 0 | 1 | 1 | 1 | E7 | g |
| 048 | 1 | 1 | 1 | 1 | 0 | 0 | 1 | 1 | 1 | F6 | H |
| 049 | 1 | 0 | 0 | 0 | 0 | 0 | 1 | 1 | 1 | 84 | I |
| 04A | 1 | 0 | 0 | 0 | 0 | 0 | 1 | 1 | 1 | 86 | J |
| 04B | 1 | 0 | 0 | 0 | 0 | 0 | 1 | 1 | 1 | 80 | K |
| 04C | 1 | 0 | 0 | 0 | 0 | 0 | 1 | 1 | 1 | 8B | L |
| 04D | 1 | 0 | 0 | 0 | 0 | 0 | 1 | 1 | 1 | 80 | M |
| 04E | 1 | 0 | 0 | 0 | 0 | 0 | 1 | 1 | 1 | D4 | N |
| 04F | 1 | 1 | 0 | 0 | 1 | 1 | 1 | 0 | 0 | DC | O |
| 050 | 1 | 1 | 0 | 0 | 1 | 1 | 1 | 1 | 1 | F3 | P |
| 051 | 1 | 1 | 0 | 0 | 1 | 1 | 1 | 1 | 1 | 80 | Q |
| 052 | 1 | 1 | 0 | 0 | 1 | 1 | 1 | 1 | 1 | 80 | R |
| 053 | 1 | 1 | 0 | 0 | 0 | 0 | 0 | 0 | 0 | 80 | S |
| 054 | 1 | 1 | 0 | 0 | 0 | 0 | 0 | 0 | 0 | 80 | T |
| 055 | 1 | 1 | 0 | 0 | 0 | 0 | 0 | 0 | 0 | 8E | U |
| 056 | 1 | 1 | 0 | 0 | 0 | 0 | 0 | 0 | 0 | 80 | V |
| 057 | 1 | 1 | 0 | 0 | 0 | 0 | 0 | 0 | 0 | 80 | W |
| 058 | 1 | 1 | 0 | 0 | 0 | 0 | 0 | 0 | 0 | 80 | X |
| 059 | 1 | 1 | 0 | 0 | 0 | 0 | 0 | 0 | 0 | 80 | Y |
| 05A | 1 | 1 | 0 | 0 | 0 | 0 | 0 | 0 | 0 | 80 | Z |
| COMMON-ANODE DISPLAY | | | | | | | | | | | |
| HEX DIGITS | | | | | | | | | | | |
| 400 | 1 | 1 | 0 | 0 | 0 | 0 | 0 | 0 | 0 | 60 | 0 |
| 401 | 1 | 1 | 1 | 1 | 0 | 0 | 0 | 0 | 0 | F9 | 1 |
| 402 | 1 | 1 | 1 | 1 | 0 | 0 | 0 | 0 | 0 | A4 | 2 |
| 403 | 1 | 0 | 1 | 1 | 1 | 0 | 0 | 0 | 0 | 80 | 3 |
| 404 | 1 | 0 | 0 | 0 | 1 | 1 | 0 | 0 | 0 | 99 | 4 |
| 405 | 1 | 0 | 0 | 0 | 0 | 0 | 1 | 1 | 0 | 92 | 5 |
| 406 | 1 | 0 | 0 | 0 | 0 | 0 | 1 | 1 | 0 | 82 | 6 |
| 407 | 1 | 1 | 1 | 1 | 1 | 0 | 0 | 0 | 0 | F8 | 7 |
| 408 | 1 | 1 | 0 | 0 | 0 | 0 | 0 | 0 | 0 | 80 | 8 |
| 409 | 1 | 0 | 0 | 0 | 0 | 0 | 0 | 0 | 0 | 90 | 9 |
| 40A | 1 | 0 | 0 | 0 | 0 | 0 | 0 | 0 | 0 | 88 | A |
| 40B | 1 | 0 | 0 | 0 | 0 | 0 | 0 | 0 | 1 | 83 | B |
| 40C | 1 | 1 | 0 | 0 | 0 | 0 | 0 | 0 | 0 | C6 | C |
| 40D | 1 | 1 | 0 | 0 | 0 | 0 | 0 | 0 | 0 | A1 | D |
| 40E | 1 | 0 | 0 | 0 | 0 | 0 | 0 | 0 | 0 | 86 | E |
| 40F | 1 | 1 | 0 | 0 | 0 | 0 | 0 | 0 | 0 | 8E | F |
| ASCII CHARACTERS | | | | | | | | | | | |
| 441 | 0 | 0 | 0 | 0 | 0 | 0 | 0 | 0 | 0 | 08 | A |
| 442 | 0 | 0 | 0 | 0 | 0 | 0 | 0 | 0 | 0 | 03 | B |
| 443 | 0 | 0 | 1 | 0 | 0 | 0 | 0 | 0 | 0 | 46 | C |
| 444 | 0 | 0 | 0 | 0 | 0 | 0 | 0 | 0 | 0 | 21 | D |
| 445 | 0 | 0 | 0 | 0 | 0 | 0 | 0 | 0 | 0 | 06 | E |
| 446 | 0 | 0 | 0 | 0 | 0 | 0 | 0 | 0 | 0 | 06 | F |
| 447 | 0 | 0 | 0 | 0 | 0 | 0 | 0 | 0 | 0 | 18 | g |
| 448 | 0 | 0 | 0 | 0 | 0 | 0 | 0 | 0 | 0 | 09 | h |
| 449 | 0 | 0 | 0 | 0 | 0 | 0 | 0 | 0 | 0 | 7B | i |
| 44A | 0 | 0 | 0 | 0 | 0 | 0 | 0 | 0 | 0 | 61 | j |
| 44B | 0 | 0 | 0 | 0 | 0 | 0 | 0 | 0 | 0 | 7F | k |
| 44C | 0 | 0 | 0 | 0 | 0 | 0 | 0 | 0 | 0 | 47 | l |
| 44D | 0 | 0 | 0 | 0 | 0 | 0 | 0 | 0 | 0 | 7F | m |
| 44E | 0 | 0 | 0 | 0 | 0 | 0 | 0 | 0 | 0 | 23 | n |
| 44F | 0 | 0 | 0 | 0 | 0 | 0 | 0 | 0 | 0 | 0C | o |
| 450 | 0 | 0 | 0 | 0 | 0 | 0 | 0 | 0 | 0 | 7F | p |
| 451 | 0 | 0 | 0 | 0 | 0 | 0 | 0 | 0 | 0 | 7F | q |
| 452 | 0 | 0 | 0 | 0 | 0 | 0 | 0 | 0 | 0 | 2F | r |
| 453 | 0 | 0 | 0 | 0 | 0 | 0 | 0 | 0 | 0 | 7F | s |
| 454 | 0 | 0 | 0 | 0 | 0 | 0 | 0 | 0 | 0 | 7F | t |
| 455 | 0 | 0 | 0 | 0 | 0 | 0 | 0 | 0 | 0 | 41 | u |
| 456 | 0 | 0 | 0 | 0 | 0 | 0 | 0 | 0 | 0 | 7F | v |
| 457 | 0 | 0 | 0 | 0 | 0 | 0 | 0 | 0 | 0 | 7F | w |
| 458 | 0 | 0 | 0 | 0 | 0 | 0 | 0 | 0 | 0 | 7F | x |
| 459 | 0 | 0 | 0 | 0 | 0 | 0 | 0 | 0 | 0 | 7F | y |
| 45A | 0 | 0 | 0 | 0 | 0 | 0 | 0 | 0 | 0 | 7F | z |

FIG. 1

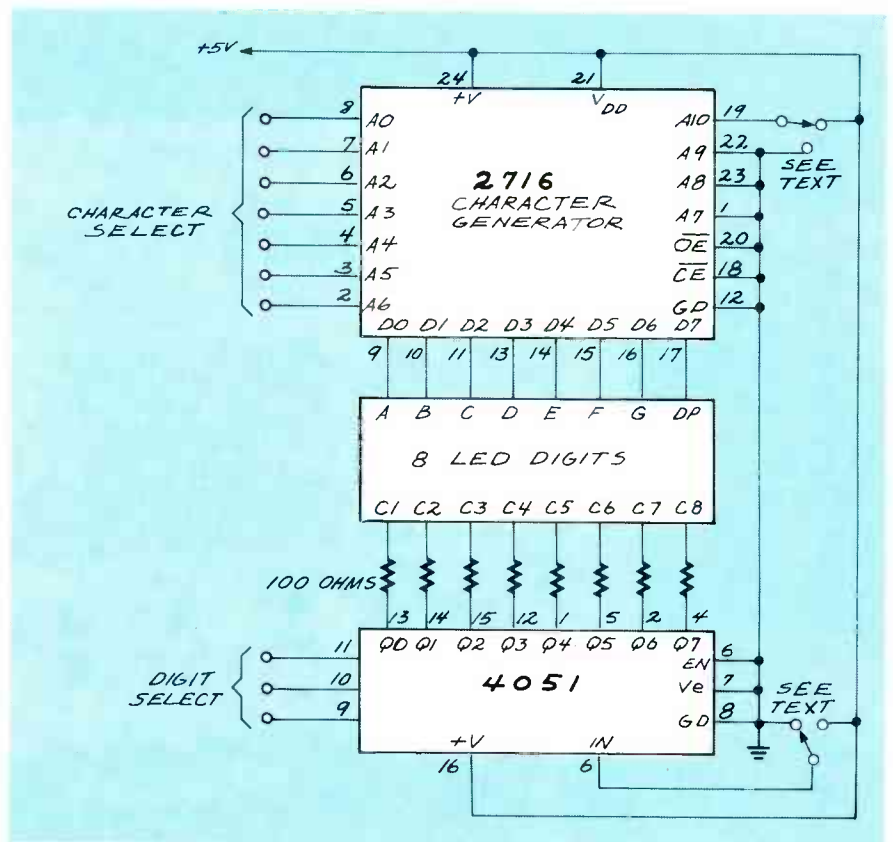

FIG. 2

kinds of creative urges. Not only do you get the opportunity to design some space-saving (as well as power) circuitry, but it also gives you the chance to make the seven-segment LED's display the characters you want in exactly the manner that you want them displayed.

Unfortunately, you run out of options almost immediately.

We've talked about the limits you run up against when you're trying to display alphabetic characters using a seven-segment display. Some of the characters are easy but there are others, such as

"K," "M," "S," and everything from "V" to "Z" are, to put it mildly, impossible. If you spend some time at it, you can probably come up with some sort of unique combination of segments to represent those characters but the chances are good that you'll be the only one who knows what they're supposed to be.

That could very easily mean that you'd have to keep an electronic Rosetta Stone next to the display—not a terrific thing.

After a lot of experimenting on my own and doing some real down

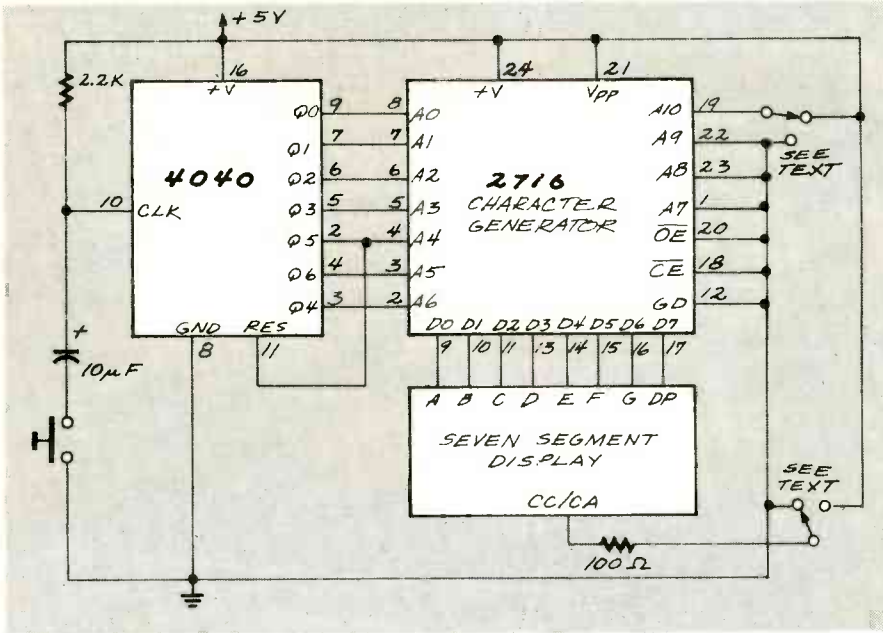

FIG. 3

and dirty market research using friends and family, I came up with the character set that was in Fig. 1 in the March issue. Everyone who saw those characters displayed on

a seven-segment LED was able to recognize them. The mix of upper- and lower-case took some explanation but once that was understood, everyone who looked at the

display was quite able to read it. But don't take my word for it—set up a small circuit to light the segments and do your own experimenting. If you come up with a more extensive character set, let me know about it.

No matter what character set you decide to use, the procedure for creating the bit pattern is exactly the same. And while designing the character set is creative and fun, working out the bit pattern for the EPROM is tedious and boring.

Once you've made a decision about which address lines will be the inputs and which data lines will be the outputs, the next step is to translate the characters into a series of ones and zeros to store in the EPROM. The chart in Fig. 1 is the programming template for my character set. Notice that all the numbers and the letters "A" through "F" are listed twice. That provides a way to distinguish between the hex digits and the ASCII characters. That may or may not be

continued on page 86

CABLE-TV band-stop filters

- FOR ELIMINATION OF SEVERE INTERFERENCE
- FOR "CENSORING" OF ADULT BROADCASTS



- ATTENUATION - 45 dB TYPICAL
- BANDWIDTH - 4 MHz AT 5 dB POINTS
- INSERTION LOSS - 2 dB

| MODEL | TUNING RANGE | FOR CHANNELS | PASSBAND | PRICE | SHIPPING/HANDLING |
|-------|--------------|-------------------------------|------------|-------|-------------------|
| 23H | 50-66 MHz | 2,3 (or 6 meter ham) | 50-300 MHz | \$30 | FREE |
| 46FM | 66-108 MHz | 4,5,6 (or any FM) | 50-300 MHz | \$30 | FREE |
| 1417 | 120-144 MHz | 14(A) 15(B) 16(C) 17(D) | 50-400 MHz | \$30 | FREE |
| 1822 | 144-174 MHz | 18(E) 19(F) 20(G) 21(H) 22(I) | 50-400 MHz | \$30 | FREE |
| 713 | 174-216 MHz | 7,8,9,10,11,12,13 | 50-400 MHz | \$30 | FREE |

3 for \$72 - 10 for \$180 - mix & match

Call Toll Free For C.O.D. or Send Check To Order
No Shipping Charges

- Shipped Within 3 Days
- 30 Day Money Back Guarantee

FACTORY DIRECT FROM

Star Circuits

P.O. Box 8067

Pembroke Pines, FL 33084

1-800-433-6319

BK PRECISION



Test

Instrument

SALE!



FREE CATALOG

MODEL 2120

Oscilloscope, 20MHz, Dual Trace
Reg. \$549.00 **SALE** Call for Quote

MODEL 1541A

Oscilloscope, 40MHz, Dual Trace
Reg. \$845.00 **SALE \$598.00**
FREE FREIGHT!!

MODEL 2160

Oscilloscope, 60MHz, Dual-Trace, with Delayed Sweep
Reg. \$1045.00 **SALE \$836.95**

MODEL 560

Programmable In/Out-of-Circuit IC Tester
Reg. \$3500.00 **SALE \$2940.95**
FREE AK560 SOFTWARE!!

MODEL CP-1

Clamp-On AC Current Probe
Reg. \$65.00 **SALE \$29.95**



MODEL 388-HD
Test Bench
Reg. \$139.00
SALE \$106.95

PRINT

Products International Inc.
8931 Brookville Rd
Silver Spring, MD 20910 U.S.A.
(800) 638-2020 (301) 587-7824

EASY ORDER FAX LINE
(800) 545-0058

Complete B & K Line Available,
"Call for your Price Quotations"

CIRCLE 187 ON FREE INFORMATION CARD

ANTIQUE RADIOS

How television got its start.



RICHARD D. FITCH
Contributing Editor

BEFORE GOING INTO THIS COLUMN, which is mostly about television, a few words of thanks to all the readers of this column—especially those who took the time to correspond. The photos sent in by many readers were really appreciated. I never realized that so many classic antique radios were still in existence. Of special interest was the 1936 Philco *Radiobar* sent in by one reader. That set looks as if it just came off the showroom floor, and I hope to share it with you in a coming issue.

The roaring 20's

The 1920's was the era when broadcast radio was developed. And, believe it or not, television saw tremendous strides during the same era. While not a household word, television was definitely in the anticipated future. Indeed, by the late 1920's, manufacturers had begun preparing the public for the coming of television.

As shown in Fig. 1, many sets like the Stewart Warner Series-950 screen-grid receiver boasted an adapter for television. We know, of course, that none of those early sets were projecting a TV image like the kind we have today. After all, the early sets didn't have a CRT (Cathode-Ray Tube), but rather, a mechanical device known as a *scanning disc*. According to the 1928-29 owners' manual: "To provide a satisfactory means of picking up television transmissions, all the series-900 receivers are provided with *television receptacles*, which contain the RF detector for receiving television broadcasts." Also, as shown in Fig. 2, on the back of the set are television termi-

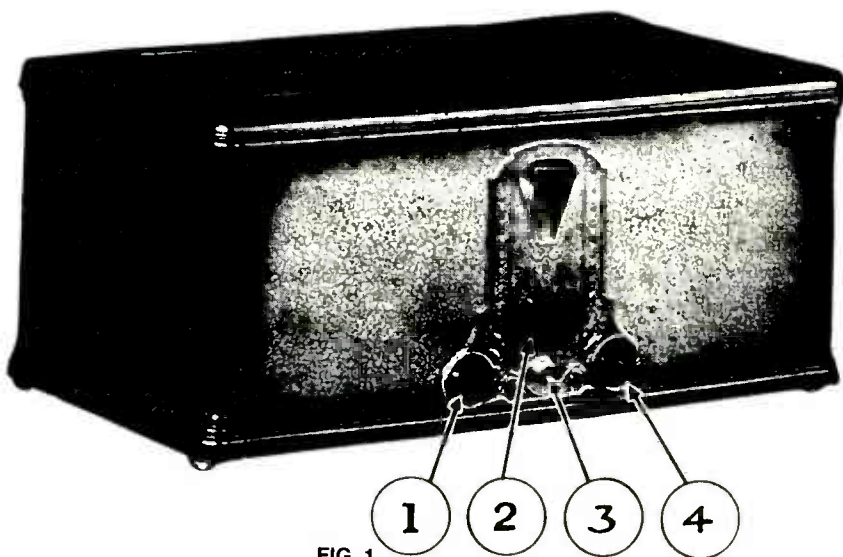

FIG. 1

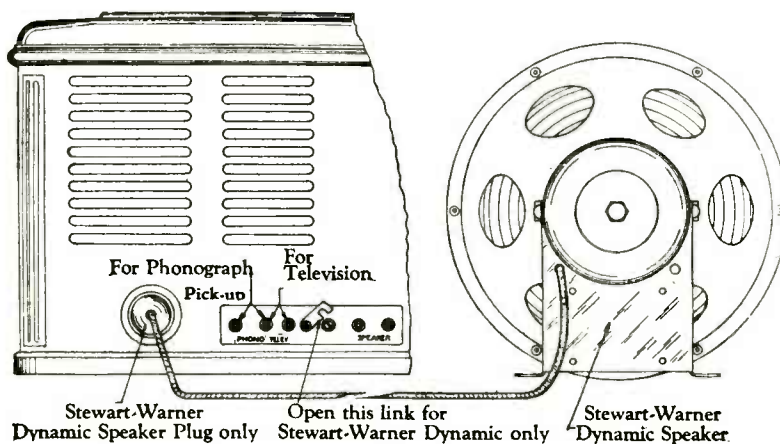

FIG. 2

nals, which provide a means for connecting the necessary amplifier and scanning-disc apparatus.

Later in this column we'll discuss the Stewart Warner Series-950 radio receiver in greater depth. I'm sure that there are still many of those fine receivers and similar sets around. Every time I mention a particular model, I'm overwhelmed by the response; the

number of such old sets still treasured by their owners is unbelievable.

Back to the television of the 1920's. Television jacks on the back of the chassis of the 1920's radios, did, of course, plant the possibility of television in the consumer's mind. It appeared that home television sets were just around the corner; especially because public

demonstrations of television seemed to keep pace with the advances in radio.

At the 1929 Chicago Radio show, one of the outstanding attractions was a commercial home *Televisor*. It was demonstrated at the DeForest Radio Companies booth. The *Televisor* was an actual production model from the Jenkins Television Corporation, and was said to be the type that would soon be available to the public. In spite of all the hoopla, it became obvious by the early 1930's that television just wasn't ready to enter the home.

The Jenkins Televisor

As shown in Fig. 3, the Jenkins *Televisor* was in a wooden cabinet. The front panel contained a recessed opening (or shadow box) through which the picture was watched. A magnifying lens (which made a comeback in the 1940's) enlarged the picture, so that many persons could watch at the same time. Below the shadow box was a metal panel where the control knobs were positioned. Two toggle switches (center) to control the loudspeaker and the picture functions, and another switch to start, accelerate and stop the motor for the scanning disc.

At that time, the Jenkins *Televisor* was said to be commercial, intended for immediate use in the average household. The *Televisor* was used in combination with a short-wave radio receiver to tune in the television signals, and required a frequency band 100-kHz wide. The RF tuner had to receive all frequencies within that band with equal strength—if it was to have a clear image. When you think about it, the *televisor* unit was really quite an accomplishment for that time.

The Baird system

Another name in developing television was John L. Baird, a Scottish inventor. In 1929, the Baird Company announced a demonstration of the Baird Television system in New York City. However, I believe Mr. Baird did some demonstrating of television as far back as 1926.

The Baird system was said to require only the bandwidth used by

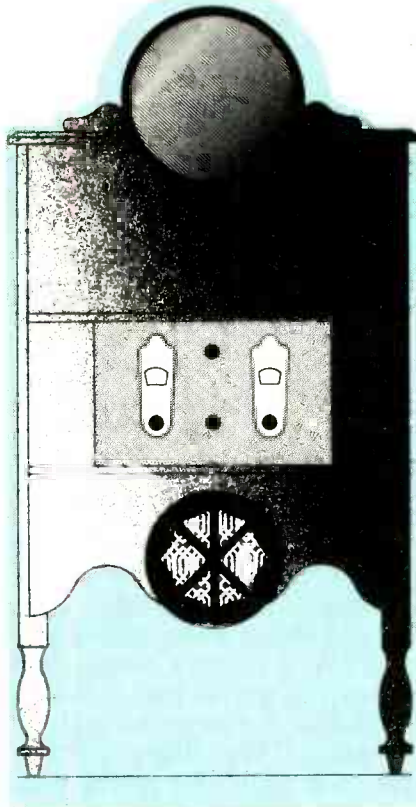
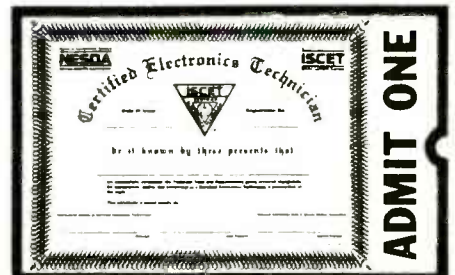

FIG. 3

American broadcasting stations. It was then possible, using the regular-wave bands allotted to speech and music, to transmit images and voices. At the time, that broadcasting was being done through London and Berlin, as well as many other places. They were all using the Baird system.

Whether or not the Baird Television Company was successful in New York, I don't know. But they were obviously very successful in Great Britain, mainly because the moving-picture houses were luring ticket buyers away from the legitimate (live) theaters. And theater organizations were contracting with the Baird Company about installing televisions in their theaters, hoping to draw customers back to the fold. The economics back then between moving-pictures and live theater was similar to what's happening today between television and the cinema, as both media compete for the cash of an entertainment-hungry public.

We have a lot more of early TV to talk about in future editions of "Antique Radios," from the Ikonophone of the late 1920's to the first CRT invented by Dr. Vladimir Zworykin, and other important TV "firsts." R-E



Your Ticket To SUCCESS

Over 25,000 technicians have gained admittance worldwide as certified professionals. Let your ticket start opening doors for you.

ISCT offers Journeyman certification in Consumer Electronics, Industrial, Medical, Communications, MATV, Radar, Computer, and Video. For more information, contact the International Society of Certified Electronics Technicians, 2708 West Berry St., Fort Worth, TX 76109 • (817) 921-9101

Name _____
Address _____
City _____
State _____ Zip _____

— Send material about ISCT and becoming certified.
— Send one "Study Guide for the Associate Level CET Test." Enclosed is \$5 (+ \$1 postage).

Get A Complete Course In

ELECTRONIC ENGINEERING

8 volumes, over 2000 pages, including all necessary math and physics. 29 examinations to help you gauge your personal progress. A truly great learning experience.

Prepare now to take advantage of the growing demand for people able to work at the engineering level.

Ask for our brochure giving complete details of content. Use your free information card number, or write us directly. **\$99.95**, Postage Included. Satisfaction guaranteed or money refunded.



**Banner
Technical
Books, Inc.**
1203 Grant Ave.
Rockford, IL 61103

CIRCLE 67 ON FREE INFORMATION CARD

HARDWARE HACKER

continued from page 68

real-world inputs, in just the same way that synthesizers can routinely generate sounds that are nearly impossible to do with a real acoustical system. So now is the time to fire up the old phase-plane plot and convert it into some brand-new art forms or some exotic "new age" toy.

For instance, Fig. 7 gives us an abstract art PostScript phase-plane plot that I recently whipped up. You can do the same thing with the BASIC language and most any computer, printer, and display screen.

So, for the first of this month's two contests, do something with a phase-plane plot and tell me about it. We'll have the usual dozen or so *Incredible Secret Money Machine* books for the better entries, and an all-expense-paid (FOB Thatcher, AZ) *tinaja quest* for two awarded to the best of all.

AUDIO UPDATE

continued from page 70

day's speaker systems do not differ fundamentally from the driver described in Rice and Kellogg's seminal paper.

The basic innovation in the new speaker can be described simply: Instead of a small, magnetically driven, metal diaphragm coupled to a horn, it used a large, stiff-paper cone driven at its apex by a "moving coil." There were (and are) significant advantages to such an arrangement. The horn and diaphragm resonances that severely distorted the sound of almost all previous designs were mostly eliminated, and the new configuration could play louder and had a much wider frequency range.

A schematic view of a dynamic speaker is shown in Figure 1. Except for the use of a ceramic ring magnet instead of an electromagnetic field coil, the operating principle is identical to the original Kellogg-Rice design. Cone motion is produced by the interaction of two magnets: One is a heavy

New tech literature

Surplus Traders are the lean and mean channeled reincarnation of the old ETCO operation. You will find some outstanding bargains in their many flyers. Their \$24.50 Hitachi VCR front ends look as if they will be most useful for receiving television on a computer monitor. Stock number is RE011.

For "raw iron" surplus, check out *Borden's Surplus Center*. Those folks have big mutha hydraulics, motors, steppers, pneumatics, and such, all at really great prices.

A free sample packet of porous plastics is now available from *Porex Technologies*. While both opaque and structurally sound, you could freely blow air or water through those while attenuating noise. As a second contest this month, just tell me about any new or unusual use for a low-cost porous plastic. Speaking of plastics, one good source for plastic gears and belts is *Plastock*.

From *Hewlett-Packard*, a latest release on their great *Opto-*

electronic Designer's Catalog. From *Teledyne*, a new and free *Data Acquisition IC Handbook* that includes bunch of useful app-notes. From *Silicon Systems*, a *Communications Products* data book. And, from *Supertex*, the latest catalog on CMOS and DMOS devices, encoders, and their smoke-detector chips.

If you are into computer-aided design, one of the latest of the free trade journals is *MicroCAD News*.

Turning to my own products, for much more info on both active filters and phase-plane quadrature art techniques, check out my *Active Filter Cookbook*. And, yes, we have custom book-on-demand bound reprint sets of all my *Hardware Hacker* columns that you have seen here, and all my *Ask The Guru* reprints from my sister column over in the *Computer Shopper* magazine.

For more on PostScript, we also stock all of the Adobe books and Apple's new fact-filled *LaserWriter Reference*. R-E

permanent magnet that is visible as a black ceramic ring at the rear of the speaker; the other is a small cylindrical electromagnetic coil of wire—known as a voice coil—that is suspended within the speaker mechanism. The voice coil is connected by very flexible wires to the driver's input terminals. When the voice coil is fed the amplifier's audio signal it produces a magnetic field that fluctuates in both strength and polarity. That varying magnetic field interacts with the fixed field of the permanent magnet, causing the freely suspended voice coil to shuttle rapidly back and forth within the magnetic gap, carrying the speaker cone along with it. The speaker cone sets up a series of compressions and rarefactions (vibrations) in the air that is heard as sound. In short, the voice coil moving in accord with the *electrical* audio signal causes the cone to produce an *acoustic* audio signal.

Back to the present

The original dynamic speakers had a fairly high-compliance soft-leather or chamois ring support-

ing the outer edges of the cones. Today, a variety of plastic foams and treated rubbers are used. The edge surround not only must support the cone without unduly restricting the long low-frequency excursions, but it also must damp and absorb the higher frequency vibrations traveling through the cone material.

Most midrange units and tweeters operate on the same principles as the larger low-frequency drivers, but their designers must contend with a different assortment of problems. It should be clear that spurious vibrations, floppiness, or cone or dome movements that are not in direct response to voice-coil movements are going to introduce aberrations in the sound produced. And so will any electrical audio signal that is not accurately converted into equivalent voice-coil movement. There are, in fact, so *many* opportunities for the active drive elements in a speaker system to go wrong that it is truly a wonder—and a tribute to Rice and Kellogg's basic design—that most of them work as well as they do. R-E

COMPUTER DIGEST

BUILD A DIGITAL to ANALOG CONVERTER

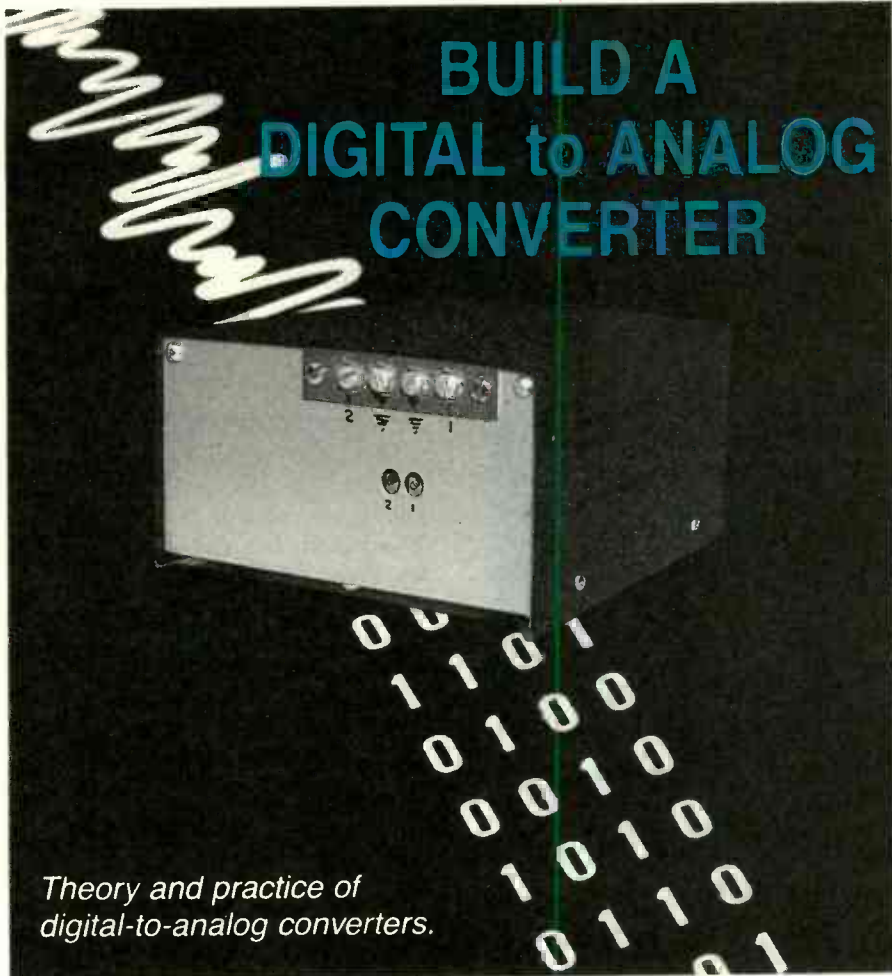

*Theory and practice of
digital-to-analog converters.*

DAVID WEBER

Computers are digital devices. In a computer, all information can ultimately be resolved into bits that are either on or off. The real world, however, is analog. The sun rises gradually, not suddenly. Temperature changes smoothly. Water flows. All human sensory inputs receive data in analog format.

However, it's difficult to represent analog values digitally. When people began to design thinking machines, they quickly discovered that devices that operated on analog principles were complicated, sensitive, and unreliable. The problem needed simplification; what greater sim-

plification than to allow no more than two states, on and off?

The problem, of course, is that operation on digital principles erects a fundamental barrier between the computer and the world outside the box. How can the computer, a yes/no device, sense much less control, analog phenomena in the real world?

Two complementary devices make both sensing and control possible: the Analog-to-Digital Converter (ADC) and the Digital-to-Analog Converter (DAC), respectively. As the name suggests, an ADC is a device that converts real-world analog quantities into digital terms that the computer can deal with. Conversely, a DAC

continued on page 81

EDITOR'S WORK- BENCH

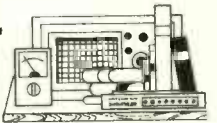

JEFF HOLTZMAN

Guard against disk errors and viruses with Disk Watcher.

The Ultimate Disk Drive has three characteristics: infinite capacity, infinite speed, and total reliability.

Unfortunately, The Ultimate Disk Drive is just a fantasy. No matter what we do, drives eventually fill up, they're never fast enough, and they're not much more reliable than used-car salesmen.

Enter RG Software Systems with Disk Watcher, an ambitious TSR (memory-resident program) that attempts to help prevent a number of common problems, ranging from the annoying to the catastrophic. The program was originally written to deal with non-malicious disk problems; with the recent publicity regarding viruses, worms, etc., the company has enhanced Disk Watcher to protect your computer against sabotage.

An annoying problem might be trying to save a word-processing file to a disk that's full. A catastrophic problem might be formatting—accidentally or maliciously—a hard disk filled with many megabytes of information. Disk Watcher gives you a way of dealing with both, and other things besides.

Let's look at some non-malicious examples first. (1) You've just finished the 25th and final chapter of The Great American Novel, and try to save it to disk. However, the disk is full. Under normal circumstances, you might or might not be in for trou-

ble, depending on how adept your word processor is at handling disk errors. With Disk Watcher loaded, however, it would pop up, let you erase some files using a small but competent visually-oriented file/disk manager (Fig. 1), and then let your word processor do its thing.

(2) It's 3 AM, you've just saved the final chapter of you-know-what to your hard disk, and you decide to create a backup copy on diskette. You open a brand new box of disks, type `FORMAT C:`, and several minutes later start searching for an unerase utility and a bottle of Maalox. If Disk Watcher had been patrolling your PC, it simply would have dumped you unceremoniously in DOS.

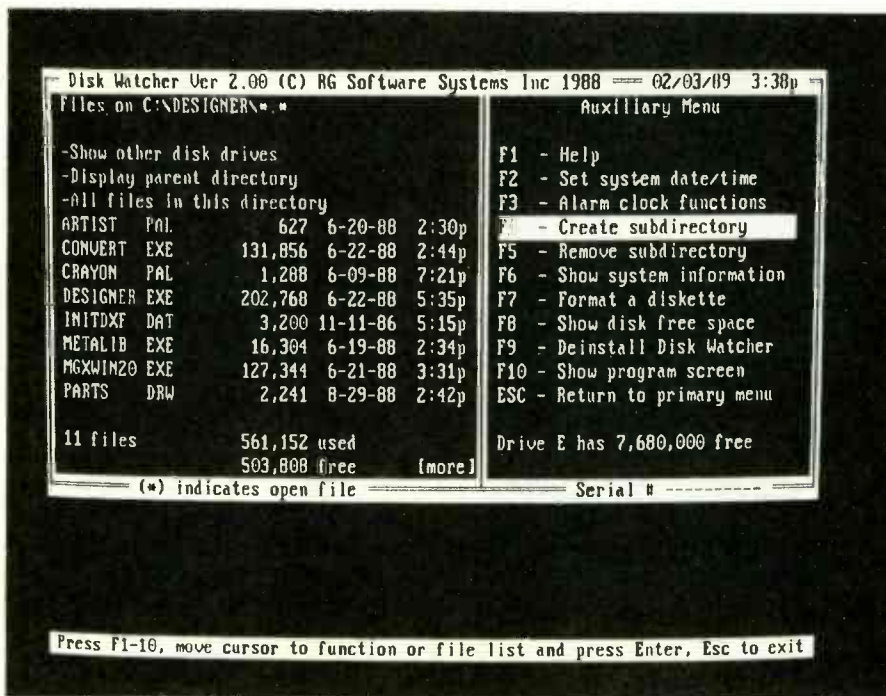

FIG. 1

(3) This one's a little trickier. You download several public-domain utility programs from a local BBS and install them on your hard disk. Several weeks later, you notice that you're running out of disk space. You clean up those old subdirectories you'd been meaning to get to, but a few days later, you're out of space again. After a little snooping, you discover that your disk is full of hidden files with odd names. A little more snooping and you find that the `COMMAND.COM` file on your hard disk is somewhat larger

than the one on your master system diskette. This is one classic way in which a computer can get corrupted.

If you had had Disk Watcher installed, any attempt to write a file with the name `COMMAND.COM` would have set bells ringing and lights flashing.

(4) By now you've learned your lesson; Disk Watcher is now part of your `AUTOEXEC.BAT` file. At a computer club meeting, a guy with shifty eyes shoves a disk at you, telling you that the program on it does everything Lotus 1-2-3, dBASE III, and WordPerfect 5.0 combined can do, occupies only 10K of RAM, and costs only \$5. You and a hundred other trusting souls buy disks. Needless to

tion." You realize that your data has gone on to that Big PC in the Sky.

What happened? That virus went straight to your hard-disk controller, and nothing in MS-DOS or the PC's hardware architecture can protect against that type of sabotage.

Running it

Disk Watcher occupies about 50K of RAM, plus memory for a screen buffer. Depending on your video adapter and on whether you use graphics modes, that buffer can range in size from 4K to 128K. However, it can be located in extended or expanded memory. Hercules, CGA, and EGA text and graphics modes are supported; VGA graphics modes are not.

After installation, Disk Watcher lurks in the background, looking for "suspicious" activities. The latter include trying to modify `AUTOEXEC.BAT`, `CONFIG.SYS`, other `sys` files, and all program files (`COM`, `EXE`, `BAT`).

If an attempt is made to modify any of those, Disk Watcher pops up to let you decide whether it's legitimate or not. At that point you can choose among several actions: you can simply shut down the system; a cold boot—either powering down or pressing a reset switch—must then be performed. You can also allow the application program to continue to run, but prevent it from writing to the disk; you can allow it to write just this once; you can allow it to write throughout the remainder of the current session; or you can tell Disk Watcher to remember the program that made the offense, and allow it that type of access in the future. (Disk Watcher maintains a data file of legitimate programs that perform "suspicious" activities.)

For example, if you edit your `AUTOEXEC.BAT` file and try to save it, Disk Watcher will pop up. At that point you can allow the save to occur normally, etc.

You can also pop up Disk Watcher at any time to perform basic file and disk management; that is its real strength. As shown in Figs. 1 and 2, you can view, create, and remove directories;

say, Mr. Shift Eyes disappears. Even though you're suspicious, you've got Disk Watcher and feel confident. Back at your PC, you start the installation program up and hear your hard disk clicking and buzzing.

A few minutes later, you see a simple message: "Installation is now complete; please reboot and start the program." You try to reboot and can't; as panic starts surging, you boot from a floppy. You try to list the directory of your hard disk, but receive only the message "Invalid drive specifica-

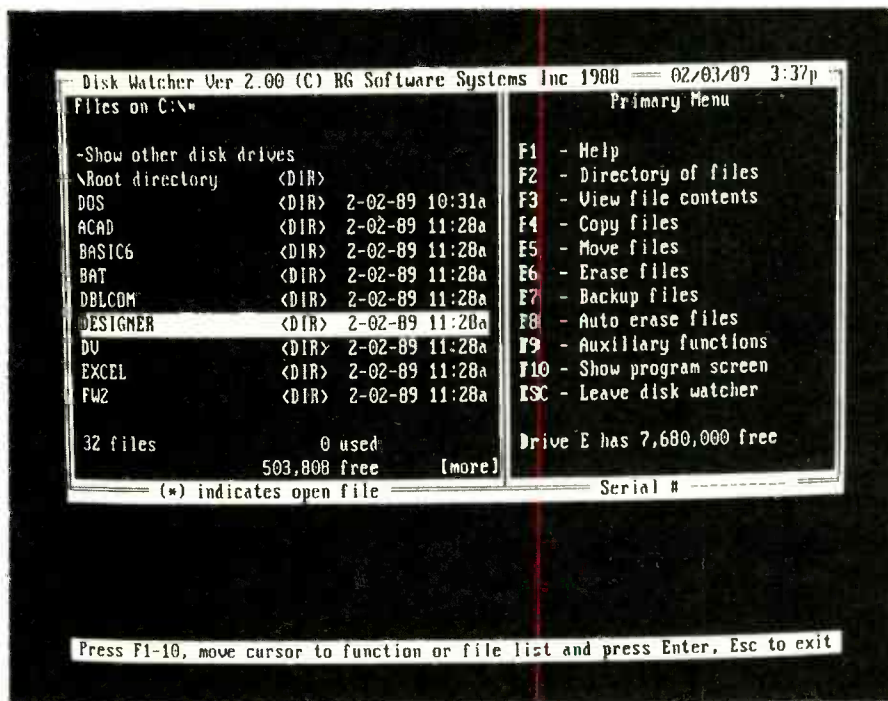

FIG. 2

copy, move, backup, view, and delete files; format diskettes; and set a pop-up alarm clock that will display a message at a specified time.

In addition, Disk Watcher provides "copy over" protection, i.e., protection from overwriting one file with another of the same name. (By itself DOS provides only the most basic protection of that sort.)

Disk Watcher also monitors several other areas of your system (printer, system clock) to ensure that everything is operating as it should. For example, if Disk Watcher finds the system date set for 1/1/80, it will tell you about it, because that means that your clock's battery may be dead. Or if you accidentally press the PrtSc key (or press it while your printer is off-line), Disk Watcher will allow you to recover gracefully.

A separate program allows you to scan for potential virus programs; the program examines all disk drives for suspicious (hidden) files, and it can "remember" legitimate hidden files (often used by copy-protected programs). Disk Watcher also examines your PC's memory allocation, and will alert you if it finds suspicious holes, at which time you can force the system to halt, ignore the error, etc.

Does it do it?

Disk Watcher makes some ambitious claims about its ability to prevent serious damage to your system. Does it live up to those claims?

Partially. Its ability to trap disk-format instructions is only good for programs that use standard resources (the BIOS disk interrupt); anything that goes directly to the hardware cannot be stopped or even detected until it's too late.

On the other hand, the threat of a virus doing serious damage to a single-user PC can be minimized by carefully selecting software. To paraphrase the old adage, *Don't accept software from strangers*. If you need or want to test unknown software, do so very carefully—preferably on a separate system with nothing to lose.

Disk Watcher aspires to monitor and protect your entire system, but it is marred by curious omissions. For example, the Ctrl-Alt-Delete sequence is not trapped; that could be done in a couple of dozen bytes.

There are bugs, too. For example, I told the file manager to move a group of files to a non-existent subdirectory. When the disk thrashing stopped, all the files in the original subdirectory

were gone; only a single file (the last one "moved") existed in the root directory; it had the name of the non-existent subdirectory.

Disk Watcher has more serious problems. For example, it does not guard system files with other extensions; for example, BIN, which is used by a popular hard-disk partition manager.

Even more, you can simply REName and DElete sensitive system files from the DOS command line. I renamed COMMAND.COM, modified it using DEBUG.COM, saved it to disk under a new name, and then restored the original name—all while Disk Watcher was loaded. It never noticed. Everything I did could be done via batch file, using only standard DOS commands and programs, to install a faulty system file. Of course, it would be easy to write an "installation" program to accomplish the same thing in a less transparent way.

I expect that the company will solve those problems. Even so, Disk Watcher provides better protection than no protection at all, especially if you're in a situation where you're exposed to lots of untested software.

And DW does provide a useful pop-up disk/file manager. It's not as powerful as full-blown packages but it doesn't use much memory either. And \$100 is not a bad price to pay to gain a little extra insurance. (Disk Watcher, RG Software Systems, 2300 Computer Ave., Willow Grove, PA 19090. (215) 659-5300) 

CIRCLE 50 ON FREE INFORMATION CARD

Updates

What follow are brief synopses of updated versions of programs we've reviewed in these pages during the past few years. All are programs we've used in the past and continue to use them today.

Turbo Professional 5.0 is a library of routines for Turbo Pascal 5.0. I cannot say enough good about this package, which has grown about 50% since version 4.0. Included are low-level routines for handling the screen and keyboard, DOS and BIOS func-

Popular Electronics IS BACK

Exciting Features, Projects, Reports, & Columns

● TELE-MONITOR

Keep detailed, tape-recorded notes of all your telephone conversations, automatically!

● AUTOMATIC VIDEOGAME SWITCH

The ultimate videogame accessory for the ultimate living-room rocket jockey!

● FUN WITH INDUCTION COILS

Impress your friends and family with these high-voltage experiments.

● DIGITAL SAWTOOTH GENERATOR

A must for your workbench, it uses digital technology to produce near-perfect waveforms.

Popular Electronics

JUNE 1989

COMBINED WITH

Hands-on Electronics



ON SALE APRIL 25, 1989



And there is more!

SCANNER SCENE—A budget scanner that's perfect for beginners.

COMPUTER BITS—Replacing the BIOS.

CIRCUIT CIRCUS—More fun with FET's.

ANTIQUE RADIO—You can't judge a radio by its cabinet.

HAM RADIO—Get ready for ham-fest season.

DX LISTENING—Sunspots, and DX'ing, are on the upswing.

PICK UP **Popular Electronics** AT YOUR FAVORITE NEWSSTAND, CONVENIENCE STORE, OR SUPERMARKET.

tions, memory management, BCD arithmetic, and new functions for handling a mouse. High-level functions let you create TSR's, windowed output, built-in help systems, data-entry screens, pick lists, and much more. If you're an occasional programmer, your mind will boggle with the possibilities TPRO5 (\$125) opens up; if programming is your meat and potatoes, here is the library you need to increase efficiency. Highly recommended. Turbo Power Software, P.O. Box 66747, Scotts Valley, CA 95066-0747. (800) 538-8157, (408) 438-8608.

CIRCLE 49 ON FREE INFORMATION CARD

Hijaak is a graphics conversion program. It can capture text and graphics screens, and Hewlett Packard LaserJet and plotter output, and convert them to a number of graphics formats, including Amiga, Dr. Halo, GEM, PCX (PC Paintbrush), TIFF, and many others. In addition to capture-and-convert, Hijaak can also be used to convert a pre-existing file in any of those formats to any other. The PostScript EPS format is also supported (output only). Version 1.1 (\$99) also supports Group III FAX files, as they are produced by most popular FAX cards for PC's (JT Fax, Intel Connection Coprocessor, Ricoh, Complete PC, etc.). Inset Systems, Inc., 71 Commerce Drive, Brookfield, CT. 06804 (800) 828-8088, (203) 775-5866.

CIRCLE 48 ON FREE INFORMATION CARD

Disk Technician Advanced is a hard-disk analyzer/repairer. You must run the program periodically (the company recommends daily use); it scans your disk looking for bad and potentially bad sectors, which it either repairs or locks out. Version 3 (\$189.95) is no longer copy protected, can run from hard or floppy disk, allows you to do destructive or non-destructive low-level formatting (with interleave specification), and more. Prime Solutions, Inc., 1940 Garnet Avenue, San Diego, CA 92109. (619) 274-5000. 

CIRCLE 47 ON FREE INFORMATION CARD

D/A CONVERTER

continued from page 77

is a device that converts the computer's digital data to analog form, usually current or voltage.

In this article we'll show what a DAC is, how it works, and how it can be used. To illustrate those ideas, we'll present construction details for building a low-cost (\$35), high-speed DAC, with as many as eight independent channels. You can connect the DAC to any standard parallel printer port. We'll also discuss the software that controls the DAC, but space precludes printing full listings. However, the software (DAC.ARC) is available on the R-E BBS (516-293-2283). A special feature of the software is an interactive full-screen editor/compiler that functions much like Borland's Turbo and Microsoft's Quick languages.

DAC basics

The most common technique for making an analog signal from a digital value is the R-2R resistor ladder; an eight-stage ladder is shown in Fig. 1. A precision reference voltage (V_{REF}) is applied to the top of the ladder; current then passes through the R-2R resistor network to ground. The strength of the output current (I_{OUT}) is determined by which of the S1 through S8 switches are open or closed.

The maximum I_{OUT} occurs when all the switches are closed, which places one end of all the 2R resistors at ground potential (disregarding the low resistance of ammeter M1). Solving for the equivalent resistance we get R, so the maximum full-scale current is V_{REF}/R . On the other hand, if only S1 is closed (S2-S8 open), then the maximum current is $V_{REF}/2R$. The current is now one-half the original full-scale current.

It should be obvious to you now that closing any combination of switches will yield a specific fraction of the full-scale current. By rapidly changing the digital word that closes and opens switches S1 through S8, a changing current will be present at I_{OUT} and

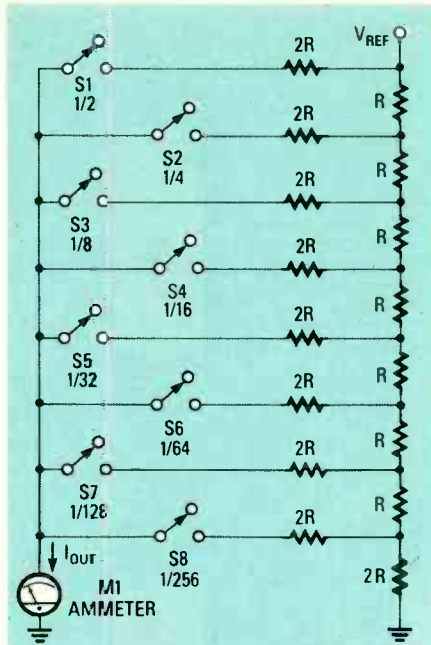

Fig. 1. THE SIMPLEST DAC: An R/2R resistor ladder. Each switch that is closed increases the amount of current at I_{OUT} .

that's digital-to-analog conversion.

The precision of I_{OUT} depends on the precision of V_{REF} on the precision of the resistors in the ladder, and on the precision with which they are matched. In addition, the number of stages in the ladder determines the fineness with which I_{OUT} can be adjusted. Commercially, eight-bit DAC's are inexpensive and readily available; sixteen-bit DAC's are available at higher cost for high-precision applications.

The DAC0808

The hardware described in this article is built around an eight-bit DAC, the DAC0808 (also known as the LM1408). It has been around for some time, is a stable design, is widely available, and is inexpensive. Eight bits give a precision of 0.39%, which is more than adequate for many uses. The typical settling time for the DAC0808 is 150 ns; that translates to a switching speed better than 5 MHz. In fact, a standard PC cannot come close to driving the converter at that speed. (A 35-kHz square wave was generated using a hand-optimized assembly-language loop on a 4-MHz CPM machine directly driving an 8255 port.)

The internal construction of the DAC0808 differs somewhat

from the idealized resistor ladder discussed here. Output is provided on two pins as complementary currents, rather than on a single output as shown in Fig. 1. Also, the lower four stages of the ladder are driven separately from the upper four, because the lower stages are more sensitive to error. The fundamental operating principles, however, are the same.

The circuit

The schematic for the circuit is shown in two parts. The first section (shown in Fig. 2) details the digital interface to the PC's parallel port. One analog section is shown in Fig. 3; bear in mind that the digital section can drive eight analog sections.

An eight-bit parallel printer port is an ideal interface for a DAC, because it is typically the fastest standard interface on a PC. The Centronics parallel port has a 36-pin connector, of which the IBM PC family uses 25; our DAC uses only 16 of those. Eight lines are for data, one is for ground, and the remaining seven are for status and handshaking.

Let's discuss the status lines (PE, BUSY, SELECT, and \overline{ERROR}) first. When power is applied to the interface, the signal levels on the PE (paper empty) and BUSY lines are low, and the levels on the \overline{ERROR} and SELECT lines are pulled high by R1 and R2. Those levels prevent the computer from hanging up, thinking that a printer was out of paper, or busy, or in an error condition. We're able to ignore the busy line because the DAC is so much faster than the computer.

When power is off, \overline{ERROR} and SELECT go low, thereby indicating to the computer that the DAC is in an error state and not selected. In that way the computer can sense whether or not the DAC is powered and ready for data.

There are three handshaking signals: RESET, STROBE, and ACK. RESET is normally used to reset a printer. In our circuit, however, RESET is used to load the value that defines which of the eight converters will receive the data that follows.

The STROBE and the ACK lines handshake data through the par-

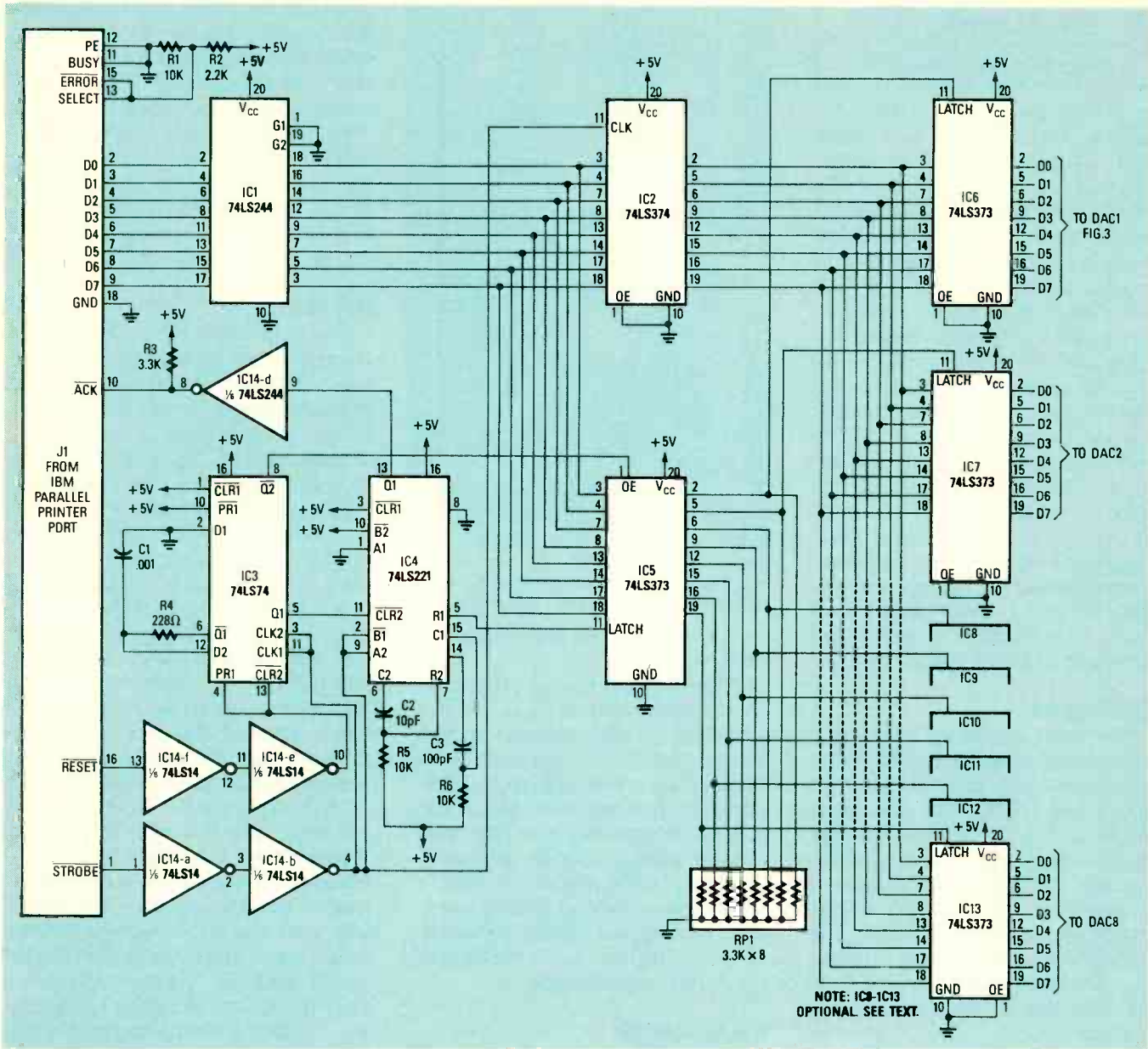

Fig. 2. DIGITAL SECTION: A standard parallel printer port can control eight digital latches, for a total of 64 bits of digital I/O.

allel port pretty much as they would for a printer. The computer puts a byte of data on D0-D7 and pulses STROBE to tell the parallel device that data is ready. The parallel device reads the data and responds with ACK to signal that everything is fine. To understand what happens in detail, let's walk through a typical data-transfer sequence. Assume that one analog section has already been selected (we'll show how that's done momentarily).

A byte of data enters the circuit and is buffered by IC1, an octal data buffer; IC1 cleans up the signals after their long journey down the cable. The data then

proceeds to IC2, an octal data latch; IC2 will latch the data when it gets STROBE from the computer. As for STROBE, it is conditioned by a pair of 74LS14 inverters, IC14-a and IC14-b. It is the rising edge of STROBE that latches the data in IC2.

The output of IC2 is presented to latches IC6-IC13; the latter are what drive the eight converters. Which latch picks up the data depends on the mask stored in IC5, but we'll get to that in a moment. For now, let's look a little closer at what STROBE does.

In addition to latching the data into IC2, STROBE drives a dual one-shot multivibrator, IC4, a

74LS221, which generates a pulse of precisely controlled width—1 μs, in this case. After buffering by IC14-d, that pulse becomes the ACK signal that tells the computer the transaction is complete.

Now let's see how the data latches (IC6-IC13) are selected by IC5, also a 74LS373. When one of IC5's outputs is high, the associated latch will be selected and its outputs will follow the data stream presented to the device. When an output is low, the latch ignores the data stream. In addition, the last value sent (when the latch enable signal was high) is retained in IC5's outputs.

Because of that arrangement,

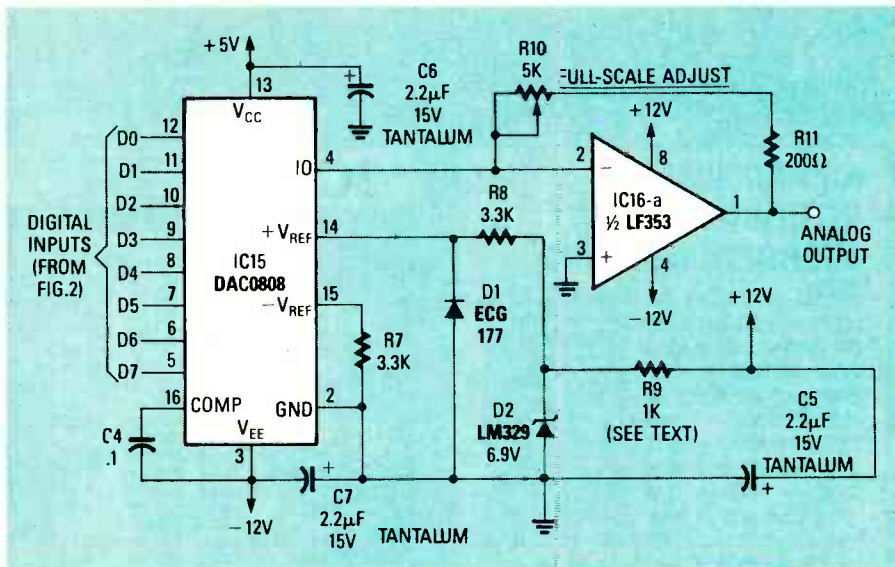

Fig. 3. ANALOG SECTION: A single channel consists of a DAC0808 (IC15) and half an op-amp (IC16-a). The voltage reference (D2) is common to all channels, but the value of the dropping resistor (R9) varies as the number of DAC's installed in the system.

the same data may be written to several latches simultaneously. For example, a mask of 0Ch (0000 1100) would enable latches three and four and disable the remaining latches. Subsequently, any data written to the device would put the same data in both latches three and four.

How is the selection mask loaded into IC5? Via the PC's RESET line. When RESET goes low, section two of IC3, a 74LS74 dual flip-flop, is cleared, and that causes IC5's output enable (\overline{OE}) line to go high. That in turn causes IC5's outputs to go into a high-impedance state, so the latch buffers (IC6-IC13) retain their current contents on their outputs. Also, those latches will ignore the next byte of data (which will be the latch-selection mask) from the PC.

Now the PC sends that selection byte; the STROBE line is pulsed, and that toggles the other half of flip-flop IC3 and also causes IC4 to send a 100-ns pulse to selection register IC5. That pulse latches the selection mask data into the selection register. The selection mask is now where it should be and has been kept out of the places where it was not wanted.

When the next data byte comes, STROBE is toggled again, so IC3 returns control of the selection lines to IC5, which now has a new mask. The data is loaded into the converter(s) specified by

the new mask.

The purpose of R4 and C1 (between the two halves of IC3) is to guarantee that the second gate is not flipped until two STROBE pulses have been sensed. The RC combination delays the response to the first STROBE for about 100 ns, leaving it ready to sense the second STROBE. Because the time delay is a function of the output drive of $\overline{Q1}$ and the input impedance of D2, substitutions should not be made for functionally equivalent IC's (74HC74, 74S74, 74F74, etc.) without verifying that the time constant remains the same, or using a different resistor or capacitor to maintain the time constant.

The analog circuit

Figure 3 shows one DAC channel. The digital circuitry can handle as many as eight DAC channels, but there's no need, of course, to build more channels than you need. However, because the analog amplifiers (IC16, an LF353) contains two amplifiers per package, it makes sense to add DAC's and associated components in pairs.

In the diagram, there are three fundamental components: the DAC, a voltage reference, and an amplifier. The DAC takes the digital number from the latch and the reference voltage from the LM329, and generates a proportional output current that drives the amplifier. Let's look at each

Parts List

Resistors

All resistors are 1/4-watt, 5% unless otherwise noted.

| | |
|-------------------------|---------------------------------------|
| R1, R5, R6 | 10,000 ohms |
| R2 | 2200 ohms |
| R3, R7, R8 | 3300 ohms |
| R4 | 220 ohms |
| R9 | 1000 ohms (for two DAC's; see text) |
| R10 | 5000 ohms, 5-turn potentiometer |
| R11 | 200 ohms |
| RP1 | 3300 ohms, 8 positions, common ground |

Capacitors

| | |
|--------------------|--|
| C1 | .0001 μ F ceramic capacitor |
| C2 | 10 pf ceramic capacitor |
| C3 | 100 pf ceramic capacitor |
| C4 | 0.1 μ F ceramic capacitor |
| C5-C7 | 2.2 μ F, 15 volts, tantalum bypass capacitor |

Semiconductors

| | |
|-----------------------|---------------------------------------|
| IC1 | 74LS244 octal buffer |
| IC2 | 74LS374 octal latch |
| IC3 | 74LS74 dual D flip-flop |
| IC4 | 74LS221 dual monostable multivibrator |
| IC5-IC7 | 74LS373 octal latch |
| IC8-IC13 | 74LS373 octal latch (optional) |
| IC14 | 74LS14 hex Schmitt trigger |
| IC15 | DAC0808 8-bit D/A converter |
| IC16 | LF353 high-speed op-amp |
| D1 | ECG177 clamping diode |
| D2 | LM329 6.9-volt precision Zener |

Miscellaneous

Perf board, power supply, IC sockets, wire, solder, etc.

component in detail.

The LM329 is a precision temperature-compensated Zener voltage reference. It creates a 6.9-volt source with a long-term stability of 0.002% and a temperature sensitivity of 0.01% per degree Centigrade. Only one LM329 is needed, regardless of the number of converters. However, the dropping resistor (R9) between the LM329 and the +12-

R-E Computer Admart

Rates: Ads are 2 1/4" x 2 3/8". One insertion \$900. Six insertions \$875. each. Twelve insertions \$845. each. Closing date same as regular rate card. Send order with remittance to Computer Admart, Radio Electronics Magazine, 500-B Bi-County Blvd., Farmingdale, NY 11735. Direct telephone inquiries to Arline Fishman, area code-516-293-3000. Only 100% Computer ads are accepted for this Admart.

SECRETS OF THE COMMODORE 64

BP135—A beginners guide to the Commodore 64 presents masses of useful data and programming tips, as well as describing how to get the best from the powerful sound and graphics facilities. We look at how the memory is organized, random numbers and ways of generating them, graphics-color-and simple animation, and even a chapter on machine code. Get your copy today. **Send \$5.00 plus \$1.25 for shipping in the U.S. to Electronic Technology Today Inc., P.O. Box 240, Massapequa Park, NY 11762-0240.**



A PRACTICAL INTRODUCTION TO MICROPROCESSORS

BP123—Introduces microprocessors by having the reader construct a very simple microprocessor circuit that he can experiment with and thus hopefully gain a clear insight into this complex subject. The completed unit is only intended as an education aid, but can be built inexpensively and many of the parts can be reused for other applications later. Get your copy for **\$5.00 plus \$1.25 for shipping in the U.S. from Electronic Technology Today Inc., P.O. Box 240, Massapequa Park, NY 11762-0240.**

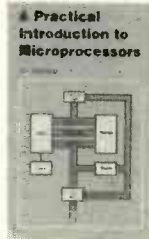

ICs PROMPT DELIVERY!!!

SAME DAY SHIPPING (USUALLY)
QUANTITY ONE PRICES SHOWN FOR FEB. 26, 1989

OUTSIDE OKLAHOMA - NO SALES TAX

| DYNAMIC RAM | | | |
|-------------|---------|--------|----------|
| SIMM (1) | 256Kx36 | 80 ns | \$600.00 |
| SIMM (1) | 1Mx9 | 80 ns | 370.00 |
| SIMM (2) | 256Kx1 | 60 ns | 140.00 |
| 1Mbit | 1Mx1 | 80 ns | 33.50 |
| 1Mbit | 1Mx1 | 100 ns | 24.50 |
| 41256 | 256Kx1 | 60 ns | 11.25 |
| 41256 | 256Kx1 | 100 ns | 10.95 |
| 51258 (3) | 256Kx1 | 100 ns | 12.95 |
| 41256 | 256Kx1 | 120 ns | 9.50 |
| 41264 (4) | 64Kx4 | 120 ns | 14.50 |
| EPROM | | | |
| 27C1000 | 128Kx8 | 200 ns | \$28.50 |
| 27C512 | 64Kx8 | 200 ns | 13.95 |
| 27256 | 32Kx8 | 150 ns | 8.15 |
| 27128 | 16Kx8 | 250 ns | 4.95 |
| STATIC RAM | | | |
| 62256P-10 | 32Kx8 | 100 ns | \$20.50 |
| 6264P-12 | 8Kx8 | 120 ns | 9.75 |
| 6116AP-12 | 2Kx8 | 120 ns | 5.50 |

OPEN 6 1/2 DAYS, 7:30 AM-10 PM: SHIP VIA FED-EX ON SAT.

WE EXPORT ONLY TO CANADA, GUAM, PUERTO RICO & VIRGIN ISLANDS

SAT DELIVERY INCLUDED ON (FED-EX ORDERS) RECEIVED BY THE END APR 98:30 PM AT \$12.50-15
MasterCard/VISA or UPS CASH COD MICROPROCESSORS UNLIMITED, INC. 24,000 S. Peach Ave. (918) 267-4961 BEGGS, OK 74421 No minimum order. Please note prices subject to change! Shipping insurance extra, up to \$1 for packing materials.

CIRCLE 61 ON FREE INFORMATION CARD

volt power supply should be adjusted for various loads. With two DAC's it should be 1000 ohms, with four it should be 510 ohms, with six, 330 ohms, and with eight, 240 ohms. In addition, even though only one dropping resistor and LM329 reference are needed for all eight converters, the 3.3K resistor (R8) and clamping diode (D1) must be duplicated for each converter.

The op-amp is a high-speed, high input-impedance, low power consumption model. It does not have a lot of output drive, but it can produce 10.0 volts across a 2K load. Its strong points are that it is very precise, that it has no offset voltage, and that it can change voltage at the maximum speed of the DAC. The feedback potentiometer (R10) on the amplifier allows you to adjust the full-scale output from 0.5 to 10.0 volts. You'll want to use a 15-turn potentiometer to make fine adjustments easily.

Construction

Unlike some projects, construction details are important. One of the most common failings of mixed analog/digital designs is noisy digital signals corrupting sensitive analog devices. So keep the analog section physically separate from the digital section, as

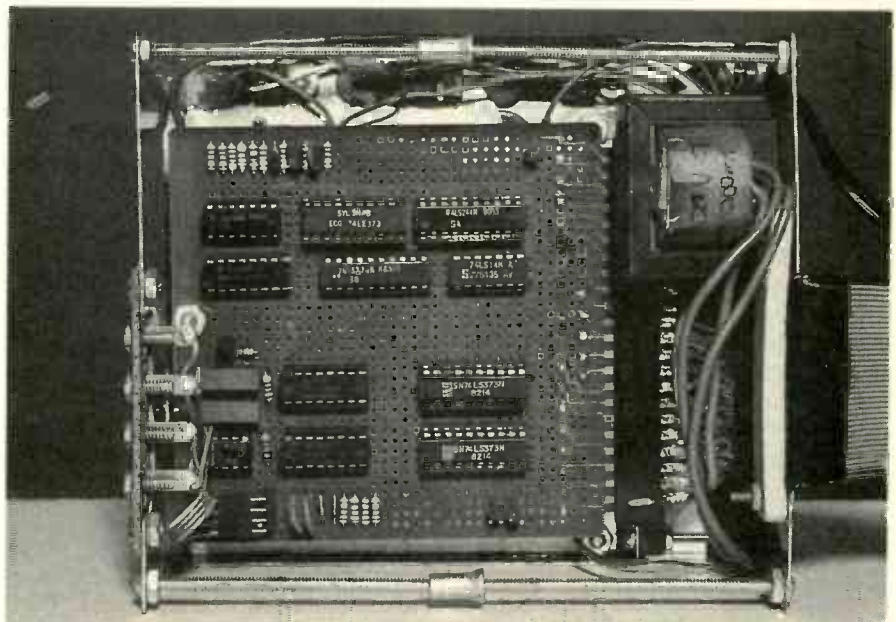

Fig. 4. SEPARATE THE ANALOG AND DIGITAL SECTIONS of the circuit. The author used point-to-point wiring.

shown in Fig. 4. In addition, keep the analog lead lines short, and make sure that the feedback resistor on the LF353 amplifier is placed close to the IC and far from the digital parts.

Some components can be substituted. A 74LS123 can replace IC4, the 74LS221. Except for IC3, each of the other digital parts can use the corresponding member of another family. For example, 74373, 74C373, 74S373, 74F373, 74HC373, 74HCT373,

74ALS373. Also, an LM1408-8 is a direct replacement for the DAC0808.

The maximum power required when driving eight DAC's into full loads is +5 volts at 250 mA, +12 volts at 100 mA, and -12 volts at 100 mA. Of course, the supply voltages must be regulated too. Power-supply bypassing is also a must. Put a 2.2-μF tantalum capacitor (C5-C7) between ground and each of the three power supplies.

TABLE 1—DACL PROGRAM STATEMENTS

| Statement | Meaning |
|-----------------------------------|---|
| or ; | The rest of the line is a comment. |
| use [1pt]p | Use parallel port 'p' for the converter. |
| reset | Reset the converters on the current port to 0.00 |
| scale, n,val | Use 'val' as a full scale value for converter 'n' |
| set n,exp | Set value of converter 'n' to expression. |
| wait t [msec, sec,min,hr] | If no units given, milliseconds assumed |
| wait until hh [:mm[:ss]] | Wait until 24 hour time. |
| do index= start, stop, step | Loop on index from start to stop by step. |
| do forever | Do forever or until user presses ESC |
| enddo | Close innermost do loop |
| nop | Do nothing except update display. |

DAC, SCHMACK

You may think that DAC's are used only in scientific laboratories and industrial controls. Actually, they're starting to show up in everything from hospital equipment to automobiles to the PC's we all use. For example, the latest display adapter for the IBM family, VGA, uses a DAC for representing the red, blue, and green signals that drive the CRT. All previous IBM display adapters were digital in nature; they were at best able to display as many as 64 colors. The VGA, by contrast, can display as many as 256,000 colors, because each color line can take on many values.

A DAC is very useful for generating test waveforms for hardware development, debugging and troubleshooting, and the like. Even something as trivial as controlling the intensity of a light show is amenable to a DAC.

identical. Each provides three function calls: one to obtain the status of the DAC; one to send a selection mask to the DAC; and one to send data to the DAC.

In addition, the author has developed a special programming language called DACL (Digital to Analog Control Language), and an integrated programming environment that allows you to experiment with programming the hardware. DACL's program statements are listed in Table 1.

The environment is illustrated in Fig. 5. With it, program development is as easy as in an interpreted language like BASIC; but run-time speed rivals that of a compiler. As shown, a full-screen editor is on the left, and current DAC status is shown on the right. Help is available by pressing Alt-H. The compiler produces plain English error messages, and leaves the editor pointing to the offending line. Debugging tools permit single-stepping through the source program. DACL comes in two versions, generic MS-DOS and IBM compatible. The first offers hardware generality, the second provides speed of execution. Sample programs and a manual are provided in DAC.ARC. **CD**

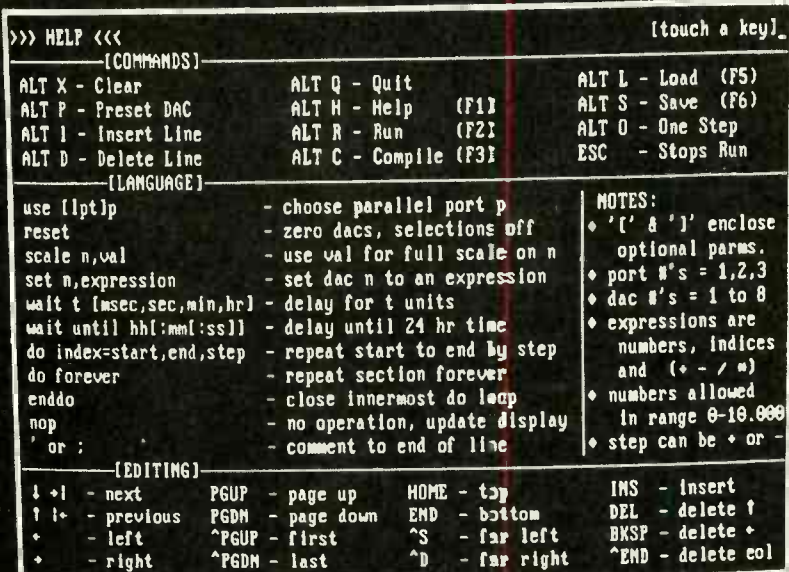

Fig. 5. THE DACL EDITOR/COMPILER. Compilation is nearly instantaneous; programs may be single-stepped.

Now calibrate the system. Unplug the device from the computer's parallel port and turn it on. Attach a voltmeter to the output terminals of the first DAC, and adjust it for the desired full-scale value. Repeat the adjustments on the second DAC and continue until all have been set.

Use

It's easy to send data and selection masks to the converter. Loading a selection mask takes three steps: First, pulse the RESET line low, then high. Second, load the selection mask on the data lines. Last, pulse the STROBE line low then high. Sending data to the converter is a two-step process. First, load the data on the

lines. Second, pulse the STROBE line low, then high.

Unfortunately, we don't have space to present program listings here. However, sample driver programs are included in DAC.ARC, which is available on the R-E BBS (516-293-2283). Two drivers are provided; DACGEN.ASM and DACPAR.ASM. DACPAR.ASM controls the parallel port directly. It is the fastest method, but requires close compatibility with the IBM standard. The other driver, DACGEN.ASM, uses the BIOS to control the parallel port. DACGEN.ASM should run on any IBM compatible, but it will transfer data at a slower rate because of the BIOS overhead.

Functionally, the drivers are

DRAWING BOARD

continued from page 73

a useful thing for you—it depends on how you plan on using the EPROM character generator.

If you don't have any use for making that kind of distinction, you can eliminate whatever you want from the programming chart; but you won't be gaining any advantage, since there's more than enough room in the EPROM for just about every character you could want.

The difference between the hex and ASCII characters is shown on the display by using the decimal point. The bit pattern is arranged so that the decimal point lights up whenever an ASCII character is sent to the display. Once you get used to the character representations, you can eliminate it, but take it from me: It comes in handy at the beginning while you're still getting used to what the characters look like.

Since there's so much room in the EPROM, I've set things up so that the chip can drive either common-cathode or common-anode displays. By using the high-order address line A10 (pin 19) as a toggle, we can select either the common-cathode bit pattern (A10 low) or the common-anode pattern (A10 high).

Using a character generator like that takes a bit of getting used to, because a large number of the ASCII characters aren't built into the chip, so they won't be displayed. I've already mentioned that the decimal point is used to indicate an ASCII character, and it also provides a way to handle the missing characters. The bit pattern is set up so that all the undisplayable characters are represented by a decimal point. That may make things somewhat cryptic when you try to put some words up on the display, but it can be a really terrific thing if your spelling's not too good.

Just kidding.

There are lots of ways to burn EPROM's. At the bottom of the scale is a setup with just a power supply and some switches but, having done that kind of thing a

long time ago, let me tell you that it's really a guaranteed ticket to the funny farm. A much better way to do it is with some sort of commercial EPROM burner. Once upon a time, those were exotic and expensive things to have on the bench, but the advent of the home computer has changed all that. There are EPROM burners available for just about every home computer on the market.

Apple and IBM EPROM burners range in price from about fifty dollars at the bottom of the scale to whatever the market will bear at the top of the scale. All of them, however, can handle 2716's. Building a custom character generator is only one way of using an EPROM to make life at the bench easier. A properly planned EPROM can take the place of acres of silicon in logic designs. That means that a circuit can be smaller, cheaper, run cooler, use less power, and last but not least, be much, much easier to debug. And if you make a programming mistake at three in the morning you can always erase the chip and start all over again.

Try doing that with something like a bipolar PROM. They may be faster, but it's really hard to repair a nichrome fuse. Even with a lot of equipment, it would be difficult.

Most EPROM programmers want a binary file—the actual hex bytes listed in the program template—to load in the EPROM. Once you've decided on the final appearance of the character set, you're ready to program the EPROM. If you're using a computer-based programmer (as most of you probably are), you'll have to type in the bytes in the hex column. If you have a modem, you can save yourself a bit of work by calling the **Radio-Electronics Bulletin Board** (516-293-2283) and downloading the file called CHARGEN.BIN. It's a 2K file that can be directly burned into a 2716.

Once you have the EPROM programmed, most of the work is done, as putting it to work in a circuit is simple and straightforward. The schematic shown in Fig. 2 is a typical example of how to use the EPROM to drive a multiplexed display. The EPROM's enable inputs are all tied to keep the chip enabled all the time and the data

outputs directly drive the anodes (or cathodes in a common-anode display) of the display. The 4051 multiplexer controls which digit will be turned on, and by constantly strobing the 4051's address pins, the circuit will handle up to eight digits.

There are other multiplexers you could use in place of the 4051, but it has the advantage of being able to have its outputs either active high or active low. Since we're making a character generator that can handle both common-anode and common-cathode displays, the chip we use for a multiplexer has to be able to handle both types of displays as well. If you use common-anode displays, both of the switches in the circuit should be connected to +V, and if you're using common-cathode displays, the switches should be connected to ground. Although there's no reason why you can't use two separate switches, a double-pole double-throw switch will do the job and keep you from making any mistakes.

And not making mistakes is always a good thing.

Needless to say, that kind of circuit arrangement is far from being complete, since there is no arrangement to latch the individual seven-segment displays and some work has to be done to make sure that the appropriate data is sent to the EPROM at the same time that the 138 is addressing the correct digit—otherwise, nothing is going to work properly.

In order to see how the EPROM works, you're much better off setting up the circuit shown in Fig. 3. That simple design can drive one digit only, but even if your application is going to call for more than just one digit, it's still useful to see how the characters we've programmed into our custom-character generator actually look on the seven-segment display.

Your job is to get the EPROM programmed and try it out, using the circuit in Fig. 3. When we get together next month, we'll flesh out the multiplexed circuit, make it self-latching, and then see how it can be used as a general-purpose display add-on for just about any circuit you might come across that needs a display. **R-E**

MARKET CENTER

FOR SALE

TUBES, new, unused. Send self-addressed, stamped envelope for list. **FALA ELECTRONICS**, Box 1376-2, Milwaukee, WI 53201.

PHOTOFACT folders, under #1400 \$4.00. Others \$6.00. Postpaid. **LOEB**, 414 Chestnut Lane, East Meadow, NY 11554.

TUBES, name brands, new, 80% off list. **KIRBY**, 298 West Carmel Drive, Carmel, IN 46032.

GREAT buys! Surplus prices, ICs, linears, transformers, PS, stepping motors, vacuum pump, phototransistor, meters, **LSASE, FERTIK'S**, 5400 Ella, Phila., PA 19120.

COMMUNICATIONS radio, electronic equipment, sales service, FCC licensed, Free catalog. **RAYS**, 2025 Moline, Ft. Worth, TX 76117. (817) 831-7717.

RESTRICTED technical information: Electronic surveillance, schematics, locksmithing, covert sciences, hacking, etc. **Huge selection. Free brochures.** **MENTOR-Z**, Drawer 1549, Asbury Park, NJ 07712.

DESCRAMBLERS. All brands. Special combo Jerrold 400 and SB3 \$165. Complete cable descrambler kit \$39. Complete satellite descrambler kit \$45.00. Free catalog. **MJM INDUSTRY**, Box 531, Bronx, NY 10461-0531.

BANDSTOP Filters-Clear up channels affected by interference. Channels 2, 3, 4, 8, 14, 15, 16, 17, 18, 19, 20, 21 and 22 available. \$20 each. **dB ELECTRONICS**, P.O.Box 8644, Pembroke Pines, FL 33084.

MICROWAVE TV RECEIVERS 1.9 to 2.7 GHz



2 CH Compact Dish System - \$77.95
 5 CH Dish System - \$93.95
 12 CH Yagi (Rod) System - \$123.95
 30 CH Dish System - \$163.90 Yagi-\$183.90
SUN MICROWAVE INT'L. INC. Send \$1⁰⁰ for
 P.O. BOX 34522 catalog on these
 PHOENIX, AZ 85067 and other fine
 (602) 230-0640 video products.
 QUANTITY DISCOUNTS LIFETIME WARRANTY

VISA/MC/COD

T.V. Tunable notch filters. Free Brochure. **D.K. VIDEO**, Box 63/6025, Margate, FL 33063. (305) 752-9202.

FAIR Pricing (313) 979-8356. Lots 5 and 10; 65 SB 55; 65 MLD 1200 55; 85 TriBi 75; 90 SA 80; 105 SSAVI 95; 295 Pioneer 275; 180 Z-Tac 170; 180 Tocom 170; 18 Filters any channel 15; No Michigan sales.

CABLE descrambler liquidation. Major makes and models available. Industry pricing! (Example: Hamlin Combo's, \$44 each...minimum 10 orders). **DEALERS ONLY!** Call **WEST COAST ELECTRONICS**, (818) 709-1758.

The DECODER. VideoCipher II newsletter. News - schematics - modifications - Reviews. \$24.00/year. Complementary sample. **TELECODE**, Box 6426, Yuma, AZ 85366-6426.

SENIOR Prom - For all your Eprom needs! Duplication, Programming, Supplies. Great Prices! Write for details. **SENIOR PROM**, 11 Manor Ridge Drive, Princeton Junction, NJ 08550.

REDUCED 75% Diehl Mark V-Scanner \$249. Diehl Mark III \$99. **NEW, WEEC** 2805 University Ave., Madison, WI 53705. (608) 233-9741, (608) 238-4629.

RADIO amateur (HAM) education. Learn at home or in your car. VHS Video or Audio Cassettes. Easy to obtain License. Free information. **AMATEUR RADIO SCHOOL** 2350 Rosalia Drive, Fullerton, CA 92635.

ALUMINUM image transfer process, your artwork to aluminum. Write: **J & E ENTERPRISES**, 2457 N. Marmora, Chicago, IL 60639.

FAIR prices SB-3, Z-TAC, SA3, TRI-BI, MLD-1200-3, Pioneer, any notch filters. **Small dealer only.** No Michigan sales **(313) 979-8356.**

SURPLUS electronics. New giant wholesale catalog. Hundreds of amazing bargains. \$2. Box 840, Champlain, NY 12919.

SOLAR electric systems. Discount prices. **SUN POWER-TEXAS**, P.O. Box 2788A-R, Freeport, TX 77541. (409) 233-8350.

CLASSIFIED AD ORDER FORM

To run your own classified ad, put one word on each of the lines below and send this form along with your check to:

Radio-Electronics Classified Ads, 500-B Bi-County Boulevard, Farmingdale, NY 11735

PLEASE INDICATE in which category of classified advertising you wish your ad to appear. For special headings, there is a surcharge of **\$25.00**.

() Plans/Kits () Business Opportunities () For Sale
 () Education/Instruction () Wanted () Satellite Television
 ()

Special Category: \$25.00

PLEASE PRINT EACH WORD SEPARATELY, IN BLOCK LETTERS.

(No refunds or credits for typesetting errors can be made unless you clearly print or type your copy.) Rates indicated are for standard style classified ads only. See below for additional charges for special ads. **Minimum: 15 words.**

| | | | | |
|--------------|--------------|---------------|---------------|---------------|
| 1 | 2 | 3 | 4 | 5 |
| 6 | 7 | 8 | 9 | 10 |
| 11 | 12 | 13 | 14 | 15 (\$46.50) |
| 16 (\$49.60) | 17 (\$52.70) | 18 (\$55.80) | 19 (\$58.90) | 20 (\$62.00) |
| 21 (\$65.10) | 22 (\$68.20) | 23 (\$71.30) | 24 (\$74.40) | 25 (\$77.50) |
| 26 (\$80.60) | 27 (\$83.70) | 28 (\$86.80) | 29 (\$89.90) | 30 (\$93.00) |
| 31 (\$96.10) | 32 (\$99.20) | 33 (\$102.30) | 34 (\$105.40) | 35 (\$108.50) |

We accept MasterCard and Visa for payment of orders. If you wish to use your credit card to pay for your ad fill in the following additional information (Sorry, no telephone orders can be accepted.):

Card Number

Expiration Date

Please Print Name

Signature

IF YOU USE A BOX NUMBER YOU MUST INCLUDE YOUR PERMANENT ADDRESS AND PHONE NUMBER FOR OUR FILES. ADS SUBMITTED WITHOUT THIS INFORMATION WILL NOT BE ACCEPTED.

CLASSIFIED COMMERCIAL RATE: (for firms or individuals offering commercial products or services) \$3.10 per word prepaid (no charge for zip code)...**MINIMUM 15 WORDS.** 5% discount for same ad in 6 issues; 10% discount for same ad in 12 issues within one year; if prepaid. **NON-COMMERCIAL RATE:** (for individuals who want to buy or sell a personal item) \$2.50 per word, prepaid...no minimum. **ONLY FIRST WORD AND NAME** set in bold caps at no extra charge. Additional bold face (not available as all caps) **55¢ per word additional.** Entire ad in boldface, \$3.70 per word. **TINT SCREEN BEHIND ENTIRE AD: \$3.85 per word. TINT SCREEN BEHIND ENTIRE AD PLUS ALL BOLD FACE AD: \$4.50 per word. EXPANDED TYPE AD: \$4.70 per word prepaid.** Entire ad in boldface, \$5.60 per word. **TINT SCREEN BEHIND ENTIRE EXPANDED TYPE AD: \$5.90 per word. TINT SCREEN BEHIND ENTIRE EXPANDED TYPE AD PLUS ALL BOLD FACE AD: \$6.80 per word. DISPLAY ADS:** 1" x 2 1/4"-\$385.00; 2" x 2 1/4"-\$770.00; 3" x 2 1/4"-\$1155.00. **General Information:** Frequency rates and prepayment discounts are available. **ALL COPY SUBJECT TO PUBLISHERS APPROVAL. ADVERTISEMENTS USING P.O. BOX ADDRESS WILL NOT BE ACCEPTED UNTIL ADVERTISER SUPPLIES PUBLISHER WITH PERMANENT ADDRESS AND PHONE NUMBER.** Copy to be in our hands on the 12th of the third month preceding the date of the issue. (i.e., Aug. issue copy must be received by May 12th). When normal closing date falls on Saturday, Sunday or Holiday, issue closes on preceding working day. Send for the classified brochure. Circle Number 49 on the Free Information Card.

3 FOR 1 SPECIAL

ON SUB-MINIATURE VOICE FM TRANSMITTERS.

KITS CONTAIN PC BOARDS



*FMX-1 LONG RANGE (3 MI) ULTRA SENSITIVE FM VOICE XMTR with fine tune, range control plus.....\$24.50



*TELX-1 TELEPHONE FM XMTR (3 MI) automatically operates when phone is used. Crystal clear clarity with fine tune and range control. Non detectable.....\$24.50



*ATR-1 AUTOMATIC TELEPHONE RECORDING DEVICE tapes telephone conversation all automatically.....\$19.50

ALL THREE OF ABOVE FOR.....\$49.50

CALL OR SEND VISA, MASTER CHARGE, MONEY ORDER, ETC. TO AMAZING CONCEPTS, BOX 716, AMHERST, NH 03031. (603) 673-4730.

FREE CATALOG

FAMOUS "FIRESTIK" BRAND CB ANTENNAS AND ACCESSORIES. QUALITY PRODUCTS FOR THE SERIOUS CB'er. SINCE 1962

FIRESTIK ANTENNA COMPANY
2614 EAST ADAMS
PHOENIX, ARIZONA 85034

CABLE TV descramblers, Jerrold, Scientific Atlanta, Zenith, most major brands. Dealer inquiries welcome. Visa-M/C accepted. E & O VIDEO, 9691 E. 265th Street, Elko, MN 55020. 1 (800) 638-6898.

CABLE TV converters/descramblers. Free Catalog! VIDEO MART 3938 E. Grant #241-C, Tucson, AZ 85712. (602) 721-6557.

ENGINEERING software. IBM/compatibles. CompDes—Circuit Design. Basic electricity through circuit designs. CompMath—General mathematics through statistics. CompView—Digital Analysis, waveforms and filters. \$49. (614) 491-0832. BSOF SOFTWARE 444 Colton Road, Columbus, OH 43207.

CB RADIO OWNERS!

We specialize in a wide variety of technical information, parts and services for CB radios. 10-Meter and FM conversion kits, repair books, plans, high-performance accessories. Over 12 years of satisfied customers! Catalog \$2.

CBC INTERNATIONAL

P.O. BOX 31500RE, PHOENIX, AZ 85046

TEST Equipment pre-owned now at affordable prices. Signal generators from \$50. Oscilloscopes from \$50, other equipment, including manuals available. Send for catalog J.B. ELECTRONICS, 9518 Grand Ave., Franklin Park, IL 60131. (312) 451-1750.

LASERS, from \$40, for brochure write MWK INDUSTRIES, 9852 W. Katella, Suite 340R, Anaheim, CA 92804. Or call (714) 956-8497.

CATV Converters & Descramblers. Quality Products. Professional Service. Call 1 (800) 541-5487. Visa/MC accepted. MOUNTAINTECH, INC. Box 5074, Mt. Crested Butte, CO 81225.

RENTAL movie stabilizer Connect between VCRs or to monitor. Satisfaction Guaranteed. \$59.95, \$4 handling. 1 (800) 367-7907.

SPECIALS - cable, satellite, computer. Stand alone EPROM programmer no computer needed. Prices and data sent on request. HI-TECH ELECTRONICS, P.O. Box 42423, Detroit, MI 48242. (313) 722-9381.

Quality Microwave TV Antennas

Multi-Channel 1.9 to 2.7 GHz. 40dB Gain
30-Channel System complete \$149.95
12-Channel System complete \$104.95
2-Channel System complete \$79.95

Philips-Tech Electronics

P.O. Box 9633 • Scottsdale, AZ 85262

(602) 947-7700 (\$3.00 Credit all phone orders)
MasterCard • Visa • C.O.D.'s Quantity Pricing.

ELECTRONIC fish detector. It brings the ageless pleasure of fishing right into the electronic age. And it's low cost is within the reach of everyone. Send \$5.00 and SASE for info to JAMES STYLER 107-51 139 St., Jamaica, NY 11435.

CABLE TV converters and descramblers. We sell only the best. Low prices. SB-3 \$79.00. We ship C.O.D. Free catalog. ACE PRODUCTS, PO Box 582 Dep't. E, Saco, ME 04072. (207) 967-0726.

CABLE Descramblers, Tocom, Zenith Z-Tac, Oak RTC 56, Jerrold 400-450, SA 8580, all remote controlled, add ons, MLD 1200, SB 3, SA-3, Pioneer, Tri Bi. Special 5 pak price, 5-Oak M35B \$300.00, 5-TC35 \$300.00, 5 MLD 1200 \$245.00. Full Warranty. S.A.C. (702) 647-3799.

GATED Pulse Decoder as described in December '88 Radio-Electronics article. Partial kit \$25.00. Works on in-band, out-band, AM or FM reference and pilotless systems. Canadian orders add \$2.00 shipping. Cannot accept Ariz. orders. Allow 4 to 6 weeks for delivery. CYBERNETWORKS., Box 41850, Phoenix, AZ 85080.

AUTO alarm module. Exit/Entry delay, on-board siren driver, unlimited inputs. Complete with wiring, hook-up diagram. \$20. Remote-controlled alarm kit. Info \$25. CHALKER 8 Manor House Lane, Uxbridge, MA 01569.

NUTS & VOLTS MAGAZINE P.O. Box 1111-E Pleasanton, CA 94670 714-632-7721

GIVE YOURSELF A BREAK — A PRICE BREAK! NUTS & VOLTS WILL SAVE YOU MONEY ON ELECTRONIC PARTS & EQUIPMENT. Plus SHOW YOU WHERE TO FIND UNIQUE, UNUSUAL AND HARD-TO-FIND ITEMS. SUBSCRIBE TODAY!

| Subscription Rates | U.S. FUNDS REQUIRED |
|----------------------|-------------------------------|
| 3rd Class Mail - USA | One Year \$12.00 |
| | Two Years \$21.00 |
| | LIFETIME \$60.00 |
| 1st Class Mail | One Year USA \$20.00 |
| | CANADA/MEXICO \$22.00 |
| | Air Mail FOREIGN 1 Yr \$55.00 |

A National Publication For The Buying And Selling Of Electronic Equipment

DESCRAMBLERS wholesale, Tocom, Zenith, Jerrold, Hamlin, Oak, SA, SB, Tri-bi, Pioneer. COD ok. GD ELECTRONICS (602) 829-9441.

TOUCHTONE programmable four digit decoder, relay controller; "TSDQ" \$79.95* convert Touchtones to RS232 300 Baud, any computer; "Dap" \$89.95* "Audio Blaster" one watt miniature amplifier fits all H.T.s; "AB15" \$22.95* Commodore C64 12 volt switching supply, crystal controlled; "DCPS" \$119.95. *Catalog \$2. MC/VISA/COD; ENGINEERING CONSULTING 583 Candlewood St., Brea, CA 92621 Tel: (714) 671-2009; Fax: (714) 255-9984.

TUBES: "oldest", "latest". Parts and Schematics. SASE for lists. STEINMETZ, 7519 Maplewood Ave., R.E., Hammond, IN 46324.

IC's digital and linear, transistors, sockets, Led's for sale. Very low prices. No minimum order. For free parts list write to: ARLI ELECTRONICS, 1052 Eilinita Ave., Glendale, CA 91208.

CABLE TV DESCRAMBLERS

| | | |
|----------------------|----------|----------------|
| JERROLD™ Tri-Bi Mode | \$105.00 | 10 Lot \$85.00 |
| JERROLD™ SB-3 OR 2 | \$89.00 | \$65.00 |
| Hamlin MLD-1200 | \$99.95 | \$62.00 |
| Oak N-12 W/V.S. | \$99.95 | \$62.00 |
| Oak-M-35-B W/V.S. | \$99.00 | \$78.00 |
| OAK E-13 | \$99.95 | \$58.00 |
| Zenith SSAVI | \$185.00 | \$145.00 |
| Eagle FD-3 | \$120.00 | \$85.00 |
| Scientific Atlanta | \$129.95 | \$105.00 |
| SA-Combo's | CALL | \$Call |
| Tocom | \$350.00 | \$295.00 |
| Oak N-12 W/ Auto | \$140.00 | \$105.00 |
| Jerrold Starcom CSV | \$139.95 | Call |

M.D. ELECTRONICS WILL MATCH ANY ADVERTISED PRICE IN THIS MAGAZINE

*NEW STARGATE 2000 CABLE CONVERTER



1-\$89.00 10-\$69.00 100-Call

Last channel recall-Favorite channel select-75 channel-Channel scan-Manual fine tune-One year warranty-surge protection-HRC & Standard switchable- and much more. Call Today!

INFORMATION(402)554-0417

Orders Call Toll Free
1-800-624-1150

M.D. ELECTRONICS
115 NEW YORK MALL
SUITE 133E
OMAHA, NE. 68114



CABLE TV DESCRAMBLERS

***** STARRING *****
JERROLD, HAMLIN, OAK
AND OTHER FAMOUS MANUFACTURERS

- FINEST WARRANTY PROGRAM AVAILABLE
 - LOWEST RETAIL/WHOLESALE PRICES IN U.S.
 - ORDERS SHIPPED FROM STOCK WITHIN 24 HOURS
- FOR FREE CATALOG ONLY 1-800-345-8927
FOR ALL INFORMATION 1-818-716-5914

PACIFIC CABLE CO. INC.

7125 W. RESEDA BLVD. DEPT. RE1189
RESEDA, CA 91355

TUBES Sylvania distributor, transistors, resistors, capacitors, coax, multi-conductor cable video, telephone accessories. ARLEN SUPPLY, 7409 West Chester Pike, Upper Darby, PA 19082. 1 (800) 458-1301.

TV instruments. Panasonic VP-7684P TV multichannel sound modulator. Panasonic VP-7682P TV multichannel sound modulator. Leader LMS-237 multichannel sound generator. END-RUN COMMUNICATIONS, 3170 Coronado Dr., Santa Clara, CA 95054. (408) 496-6007.

COMMODORE/Amiga chips, diagnostics, parts or low cost repairs (eg. C64 - \$49.95 + UPS). Catalog and dealer pricing available. Visa/MC. KASARA MICROSYSTEMS (Division of QEP), Route 9W/ Kay Fries Drive, Stony Point, NY 10980, 1 (800) 248-2983 or (914) 942-2252.

BUY BONDS

FASTEST color TV repairs anyone can do. 100 priceless secrets. \$2.00 for sample. **CHECMATE COMMUNICATIONS** P.O. Box 11-0808, Brooklyn, NY 11211.

IS it true ... Jeeps for \$44 through the government? Call for facts! 1 (312) 742-1142 Ext. 4673.

ELECTRONIC components. Free 192 page catalog including capacitors, resistors, relays, connectors, soldering equipment and supplies. **BOX 699, Mansfield, TX 76063. 1 (800) 992-9943.**

SATELLITE TV

CABLE TV Secrets - the outlaw publication the cable companies tried to ban. HBO, Movie Channel, Showtime, descramblers, converters, etc. Supplier's list included \$8.95. **CABLE FACTS**, Box 711-R, Pataskala, OH 43062.

SATELLITE TV receiver kits! Instruction manuals! Boards! Semiconductor parts! 59 deg LNA's! LNB's! Ku-Band LNB's! Catalog \$1.00 **XANDI ELECTRONICS**, Box 25647, Dept. 21TT, Tempe, AZ 85285-5647.

CABLE T.V. "BOXES"

**Converters—Descramblers
Remote Controls—Accessories**

- ★ Guaranteed Best Prices ★
- ★ 1 Year Warranty—C.O.D.'s ★
- ★ Immediate Shipping ★
- ★ FREE CATALOG ★

Call or Write
TRANS-WORLD CABLE CO.
12062 Southwest 117th Court, Suite 126
Miami, Florida 33186
800-442-9333

VIDEOCIPHER II descrambling manual, schematics, video and audio. Explains DES, EPROM, Wizardplus, KeysRus, CloneMaster, 3Musketeer. Pay-per-view (HBO, Cinemax, Showtime, adult, etc.) \$13.95, \$2 postage. **CABLETRONICS**, Box 30502R, Bethesda, MD 20814.

VIDEOCIPHER II Manuals. Volume 1 - hardware. Volume 2 - software. Either \$32.45. Both \$54.95. Volume 3 - Projects/software - \$42.45. **NEW!!!** Volume 4 - Repair - \$97.45. **COD's 1 (602) 782-2316.** Catalog - \$3.00 **TELECODE** Box 6426-R, Yuma, AZ 85366-6426.

DESCRAMBLERS for movies, networks, \$175, video \$450 complete. Visa, MC Accepted. Catalog \$4. **SKYWATCH** 238 Davenport Road, Toronto, Canada, M5R-1J6.

PAY TV AND SATELLITE DESCRAMBLING NEW... 1989 EDITION... NEW

The newest systems, parameters, turn-ons, harassment and countermeasures being used by and against cable, wireless and satellite operators. New original information \$15.95. Pay TV Vol. 1 \$14.95. Volume 2 \$12.95. Experiences with VC \$12.95. MDS/MMDS Handbook \$9.95. Build Satellite Systems Under \$600. \$12.95. Any 3/\$28 or 6/\$42. Scrambling News Monthly \$24.95/yr. Sample \$3. Scrambling News Year 1 (200 pages) \$22.95. New Spring Catalog \$1 or call.

Scrambling News, 1552 Hertei Ave., Buffalo, N.Y. 14216 **COD's 716-874-2088**

FREE catalog Systems, Upgrades, Houston, Uden, Chaparral, etc. SAVE \$\$\$\$\$ SKYVISION 2009 Collegeway, Fergus Falls, MN 56537. 1 (800) 334-6455.

VIDEOCIPHER II Chips. Send **SASE** for info. 3715 Murdoch Ave. 109, Parkersburg, WV 26102.

GLOBAL CABLE NETWORK

CABLE TV descramblers. All makes and models. Lowest prices guaranteed. **OAK M35B \$60, Hamlin CRX5000 w/remote \$135, Zenith \$140.** Call today. (702) 887-3894.

CABLE-TV

**WE'LL MATCH OR BEAT ANYONE'S
ADVERTISED RETAIL OR WHOLESALE PRICES!**

BONANZA!

| ITEM | 1 UNIT | 10 OR MORE |
|---|--------|------------|
| HAMLIN MCC 3000 36 CODED REMOTE CONVERTER (Ch 1 only) | 29.00 | 18.00 |
| PANASONIC WIRELESS CONVERTER (our best buy) | 98.00 | 79.00 |
| STAR GATE 2000 | 88.00 | 69.00 |
| JERROLD 400 COMBO | 169.00 | 119.00 |
| JERROLD 400 HAND REMOTE CONTROL | 29.00 | 18.00 |
| JERROLD 450 COMBO | 199.00 | 139.00 |
| JERROLD 450 HAND REMOTE CONTROL | 29.00 | 18.00 |
| JERROLD SB-ADD-ON | 99.00 | 63.00 |
| JERROLD SB-ADD-ON WITH TRIMODE | 109.00 | 75.00 |
| M-35 B COMBO UNIT (Ch 3 output only) | 99.00 | 70.00 |
| M-35 B COMBO UNIT WITH VARISYNC | 109.00 | 75.00 |
| MINICODE (N-12) | 99.00 | 62.00 |
| MINICODE (N-12) WITH VARISYNC | 109.00 | 65.00 |
| MINICODE VARISYNC WITH AUTO ON-OFF | 145.00 | 105.00 |
| ECONOCODE (minicode substitute) | 69.00 | 42.00 |
| ECONOCODE WITH VARISYNC | 79.00 | 46.00 |
| MLD-1200-3 (Ch 3 output) | 99.00 | 62.00 |
| MLD-1200-2 (Ch 2 output) | 99.00 | 62.00 |
| ZENITH SSAVI CABLE READY | 175.00 | 125.00 |
| INTERFERENCE FILTERS (Ch 3 only) | 24.00 | 14.00 |
| EAGLE PD-3 DESCRAMBLER (Ch 3 output only) | 119.00 | 65.00 |
| SCIENTIFIC ATLANTA ADD-ON REPLACEMENT DESCRAMBLER | 119.00 | 85.00 |

CALL FOR AVAILABILITY

| Quantity | Item | Output Channel | Price Each | TOTAL PRICE |
|--|------|----------------|------------------------------|-------------|
| | | | | |
| | | | | |
| | | | | |
| | | | | |
| | | | | |
| | | | | |
| | | | | |
| | | | | |
| | | | | |
| | | | | |
| California Penal Code #593-D forbids us from shipping any cable descrambling unit to anyone residing in the state of California. | | | SUBTOTAL | |
| Prices subject to change without notice. | | | Shipping Add \$3.00 per unit | |
| | | | COD & Credit Cards — Add 5% | |
| | | | TOTAL | |

PLEASE PRINT

Name _____
 Address _____ City _____
 State _____ Zip _____ Phone Number () _____
 Cashier's Check Money Order COD Visa Mastercard
 Acct # _____ Exp. Date _____
 Signature _____

FOR OUR RECORDS:

DECLARATION OF AUTHORIZED USE — I, the undersigned, do hereby declare under penalty of perjury that all products purchased, now and in the future, will only be used on cable TV systems with proper authorization from local officials or cable company officials in accordance with all applicable federal and state laws. **FEDERAL AND VARIOUS STATE LAWS PROVIDE FOR SUBSTANTIAL CRIMINAL AND CIVIL PENALTIES FOR UNAUTHORIZED USE.**

Dated: _____ Signed: _____

Pacific Cable Company, Inc.

7325 1/2 RESEDA BLVD., DEPT. # R-5 • RESEDA, CA 91335
 (818) 716-5914 • No Collect Calls • (818) 716-5140

IMPORTANT: WHEN CALLING FOR INFORMATION
 Please have the make and model # of the equipment used in your area. Thank You

THE ELECTRONIC GOLDMINE



Send for your copy of our 1989 catalog featuring hundreds of electronic components and unique electronic project kits. Each of our project kits include all necessary parts and a glass epoxy etched and drilled PC board - you only need to solder in the parts and provide a battery (on battery operated kits)

Here are two examples of our Unique Kits!

SIMULATED LASER KIT

Kit emits bright pulsating red light from a 500mcd Stanley LED. Simulate lasers or light your science projects! Kit can project a small (1 ft.) circle about 10 feet in a dark room. Operates from 9v battery (not included).
G6394 \$8.00



INSANITY ALARM KIT

When light is shining on the kit, the alarm is silent. But turnoff the light, and this kit will emit a high pitched sound! Turn the lights back on silent! Great fun at parties! Operates from 9v battery (not included).
G6240 \$6.98



Fabulous Component Values!

MOTOROLA 2N3055



.59

GRAVITY SWITCH



29 EACH

ALL COLOR LED ASSY.



Various shapes, colors and sizes. Pkg. of 10 for 2.25

1 3/8" XENON STROBE TUBE & TRIG COIL



1.75
50 sets for 75.00

PIEZO DISC Great experiment or tone



.69 EACH

ELECTREC MICROPHONE



.50

MINIMUM ORDER \$10.00 plus 3.00 shipping and handling. We accept M/C, Visa and money orders. COD fee: 2.50 in addition to 3.00 shipping charge.
SEND ORDERS TO: The Electronic Goldmine
P.O. Box 5409 Scottsdale, AZ 85261
PHONE ORDERS: (602) 451-7434

CIRCLE 178 ON FREE INFORMATION CARD

*****FEATURING*****

DESCRAMBLERS

FOR
CABLE T.V.

Cable Network Product - Top Quality and Best Prices Guaranteed

QUALITY

VS.
THE REST

Here is what you might hear. "We got the lowest prices we'll beat their best advertised wholesale or retail price." The reason for this is a few less components here and there what difference does it make? Sad but true this is the way other companies operate. This is why Cable Network stands alone on Quality & Best Price.

Cable Network Company
11111 "M" St. Suite A13
Omaha, NE 68137 Dept. RE

| | | |
|-------------------------------|----------|---------|
| Jerrold™ SR-3 | \$5.00 | \$5.00 |
| Super Tri-Mode | \$9.00 | \$9.00 |
| (Works on all Jerrold But BB) | | |
| Oak™ N-12 w/VS | \$9.00 | \$8.00 |
| Scientific Atlanta™ | \$109.00 | \$70.00 |
| (Works on all SA's but DF) | | |
| Hamlin™ | \$95.00 | \$45.00 |
| Zenith™ ST1000 | \$175.00 | \$70.00 |

We Care! Info, Orders & Catalogs Call
(402)331-3228

*****FEATURING*****

PLANS AND KITS

BUILD this five-digit panel meter and square-wave generator including an ohms, capacitance and frequency meter. Detailed instructions \$2.50. **BAG-NALL ELECTRONICS**, 179 May, Fairfield, CT 06430.

FM transmitter 88 to 108 MHz kit \$12.95 **Sierra Electronics**, Box 709, Eilers, FL 34680-0709.

ELECTRONIC Kits! Transmitters! Recorders! Phone devices! Bug detectors! Surveillance items! More! Catalog \$1.00: **XANDI ELECTRONICS**, Box 25647, 60N, Tempe, AZ 85285-5647.

FM stereo transmitter. Transmit your VCR/CD/Walkman to any stereo radio. One chip does it all! Free schematic and info. Send a self addressed/stamped envelope to: **DJ INC.**, 847A Second Ave., Suite 113, New York, NY 10017.

DESCRAMBLING, new secret manual. Build your own descramblers for **Cable and Subscription TV**. Instructions, schematics, for SSAVI, gated sync, sinewave. Jerrold, Hamlin, Oak, Zenith, Sylvania (HBO, Cinemas, Showtime, UHF, Adult) \$8.95, \$2 postage. **CABLETRONICS**, Box 30502R, Bethesda, MD 20814.

RADIO Astronomy! Monthly magazine, books, components. \$3.00 brings sample package. **BOB'S ELECTRONIC SERVICE**, 7605 Deland, Ft. Pierce, FL 34951.

REMOTE CONTROL KEYCHAIN

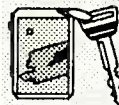

Complete w/mini-transmitter and +5 vdc RF receiver Fully assembled including plans to build your own auto alarm. Quantity discounts available

\$19.95

Check, Visa or M/C Add \$2 shipping
VISITECT INC. (415) 872-0128
PO BOX 5442, SO. SAN FRAN., CA 94080

CB tricks booklet. Modifications, tune-ups, channel expansion, clarifier tricks. Send \$19.95 to **MEDICINE MAN CB**, P.O. Box 37, Clarksville, AR 72830.

INVESTIGATORS, Experimenters. Quality new plans hard to find. Micro and restricted devices. Free catalog. **SASE KELLEY SECURITY, INC.**, Suite 90, 2531 Sawtelle Blvd., Los Angeles, CA 90064.

SNOOPER stopper kit of parts, educational manual prevents cable company spy's discovering descramblers, extra hookups. \$19.95. **WORLD MARKET IMPORTS**, MPO-476, Saint John, Canada, E2L-3Z8.

START YOUR CAR ENGINE FROM A REMOTE LOCATION SUCH AS YOUR ROOM OR OFFICE



Controller starts or stops engine upon command. Automatic shut off after ten minutes. Activates any pre-set accessory (Heater, Air-Conditioner, lights, etc.)... Theft proof... Door, parking brake, Gear selector. Controller kit with complete assembly, easy installation, and test instructions.

ONLY \$59.95
Check/Money Order 30 days refund
NYEC (516) 752-9668
P.O. BOX 594, DEPT. HA328, SYOSSET, NY 11791

CIRCUIT boards from this and past issues PC-Service about half price. **KLAY-CORP.** 106 Mark Drive, Syracuse, NY 13209-1808. Phone (315) 635-5862.

OPENING special. Super duper kits. Send \$2.00 U.S. \$ for booklet to **3C TECHNOLOGY** Box 306, S. Laffache, St. Hubert, Quebec, J4T-3J2.

SURVEILLANCE equipment design gives 58 schematics of Sheffield Electronics' surveillance devices. Circuits explained. Transmitters range from pens to one-mile VOX's including crystal, subcarrier, carrier current, infrared, firefly, automobile. Demodulators given. Cube tap and duplex mains powered transmitters presented. Eighteen telephone transmitters are leech and battery types including crystal and subcarrier. Countermeasures chapter. Much more. This 8 1/2 x 11-inch 110 page book is illustrated with photographs. Price \$30.00 + \$4.00 S & H. First class mail U.S. & Canada. One-day processing, pay with Money Order or Cashier's Check. Send to: **WINSTON ARRINGTON**, 7223 Stony Island Ave., Chicago, IL 60649-2806.

PRINTED circuit boards etched & drilled. Free delivery. **K & F ELECTRONICS, INC.**, 33041 Groesbeck, Fraser, MI 48026. (313) 294-8720.

FM-receiver kits. Narrow band single chip design, tunable. Easy to align. 46-50MHz (cordless phone) or 144-162MHz (2-meter). **SASE** for info. **TRANSCIENCE ENGINEERING**, 41584 Bedford, Canton, MI 48187.

DETECTION - surveillance, debugging. Plans, kits, assembled devices. Latest high-tech catalog \$5. **DETECTION SYSTEMS**, 2515 E. Thomas, #16-864F, Phoenix, AZ 85016.

NEW VHS VU-THRU DIAGNOSTIC TOOL

The new VU-THRU is a clear jig that allows operation of a VHS machine as if there were a tape in it. It lets you instantly see the problem. Cuts diagnostic time to a minimum.

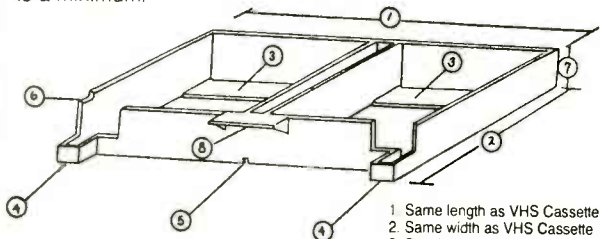

ONLY ... **\$14.95**
each plus shipping

Call Toll FREE ...

1-800-558-9572

In Wisconsin 1-800-242-9553

Ask for your FREE copy of our 1989 Catalog with over 12,000 electronic parts and accessories.



P. O. Box 28 • Whitewater, Wisconsin 53190

CIRCLE 185 ON FREE INFORMATION CARD

One tree can make 3,000,000 matches.



One match can burn 3,000,000 trees.



7400 TTL

| part | per 100 | per 1000 | part | per 100 | per 1000 |
|-------|---------|----------|------|---------|----------|
| 7400 | .14 ea | .10 ea | 7420 | .14 ea | .10 ea |
| 7410 | .14 | .10 | 7430 | .14 | .10 |
| 74123 | .29 | .19 | 7474 | .22 | .15 |
| 74151 | .35 | .24 | 7486 | .26 | .18 |
| 74153 | .35 | .24 | | | |

ADD \$3.00 per order for shipping

NEW SENSOR CORPORATION

Suite 526, 245 E. 63rd St., NYC, NY 10021 212-980-6748

SURVEILLANCE, debugging, protection. Worlds largest new catalog - \$5.00 kits - assembled - all price ranges. **TECHNOLOGY SERVICES**, 829 Ginette Street, Gretna, LA 70056.

REVERSE utility meters - phone color boxes - phreaking - 80+ unusual publications catalog \$1.00 - **ALTERNATIVES**, Box 4R, Carthage, TX 75633-0004.

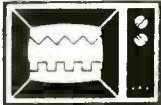

FINALLY!

An interesting and worthwhile project. This **EASY-TO-BUILD** circuit lets you use any regular TV set as a simple **OSCILLOSCOPE**. Build for less than \$10. **NO MODIFICATIONS TO TV!** Single or dual trace. Send for **FREE CATALOG** of other plans and kits.

DETAILED PLANS: \$4.95

TV-SCOPE

PENN RESEARCH,
Box 3543
Williamsport, PA 17701

PROJECTION TV... Convert your TV to project 7 foot picture... Easy!... Results comparable to \$2,500 projectors... **Plans and B" lens** \$24.95... Professional systems available... Illustrated catalog free. **MACROCOMA**, 15GI Main Street, Washington Crossing, PA 18977... Credit card orders 24HRS. (215) 736-3979.

HOME automation! Practical circuit mutes Stereo/TV while phone is ringing/in use. Plans: \$5. **COYOTE CONTRACTIONS** 1906 S. Espina, Suite 30, Las Cruces, NM 88001.

EDUCATION & INSTRUCTION

MAGIC! Four illustrated lessons plus inside information shows you how. We provide almost 50 tricks including equipment for four professional effects. You get a binder to keep the materials in, and a one-year membership in the International Performing Magicians with a plastic membership card that has your name gold-embossed. You get a one-year subscription to our quarterly newsletter "IT's MAGIC!" Order now! \$29.95 for each course + \$3.50 postage and handling. (New York residents add applicable state and local sales tax). **THE MAGIC COURSE**, 500-B BiCounty Boulevard, Farmingdale, NY 11735.

FCC commercial general radiotelephone license prep course by correspondence. 60 individual lessons, \$89.50. Payment plan. Also **Basic Computers**, \$39.50; certificates. Details free. **AMERICAN TECHNICAL INSTITUTE**, Box 201, Cedar Mountain, NC 28718.

TECHNICIANS send your resume to over 1000 existing Atlanta employers of electronic technicians. List of 20 categories \$2.00 refundable. **TECH SEARCH INC.**, P.O. Box 2855, Atlanta, GA 30301.

CAN you solder properly??? Find out. Free info. **SOLDERING**, P.O. Box 6244-R, Abilene, TX 79608.

DIGITAL CAR DASHBOARDS

BUILD yourself complete electronic dashboards. Send \$1 (refundable) for details. **MODERN LABS**, 2900N Ruisseau, Saint-Elizabeth, QC, JOK 2JO, Canada.

PRIVACY PROTECTION

SURVEILLANCE and counter-surveillance equipment catalog. Send 5.00. **RWB ELECTRONICS** Box 922, Bronxville, NY 10708.

AMAZING SCIENTIFIC & ELECTRONIC PRODUCTS

PLANS

Build Yourself - All Parts Available in Stock

| | | |
|------|--|---------|
| LCT | BURNING CUTTING CO. LASER | \$20.00 |
| RUB4 | PORTABLE LASER RAY PISTOL | \$20.00 |
| TCC1 | 3 SEPARATE TESLA COIL PLANS TO 1.5 MCV | \$25.00 |
| IGG1 | ION RAY GUN | \$10.00 |
| GRAT | GRAVITY GENERATOR | \$10.00 |
| EMLI | ELECTRO MAGNET COIL GUN/LAUNCHER | \$8.00 |

KITS

With All Necessary Plans

| | | |
|--------|--|----------|
| MFT3K | FM VOICE TRANSMITTER 3 MI RANGE | \$49.50 |
| VWPM7K | TELEPHONE TRANSMITTER 3 MI RANGE | \$39.50 |
| BTC3K | 250,000 VOLT 10-14" SPARK TESLA COIL | \$249.50 |
| LHC2K | SIMULATED MULTICOLOR LASER | \$44.50 |
| BLS1K | 100,000 WATT BLASTER DEFENSE DEVICE | \$69.50 |
| ITM1K | 100,000 VOLT 20" AFFECTIVE RANGE INTIMIDATOR | \$69.50 |
| PSP4K | TIME VARIANT SHOCK WAVE PISTOL | \$59.50 |
| STAK | ALL NEW SPACE AGE ACTIVE PLASMA SABER | \$59.50 |
| MVPIK | SEE IN DARK KIT | \$199.50 |
| PTG1K | SPECTACULAR PLASMA TORNADO GENERATOR | \$149.50 |

ASSEMBLED

With All Necessary Instructions

| | | |
|-------|--|----------|
| BTC10 | 50,000 VOLT-WORLD'S SMALLEST TESLA COIL | \$54.50 |
| LGU40 | 1MW HeNe VISIBLE RED LASER GUN | \$249.50 |
| TAT30 | AUTO TELEPHONE RECORDING DEVICE | \$24.50 |
| GVPI0 | SEE IN TOTAL DARKNESS IR VIEWER | \$349.50 |
| LIS10 | SNOOPER PHONE INFINITY TRANSMITTER | \$169.50 |
| IPG70 | INVISIBLE PAIN FIELD GENERATOR MULT MODE | \$74.50 |

• CATALOG CONTAINING DESCRIPTIONS OF ABOVE PLUS HUNDREDS MORE AVAILABLE FOR \$1.00 OR USE OUR PHONE FOR "ORDERS ONLY" 603-673-4730.

PLEASE INCLUDE \$3.00 PH ON ALL KITS AND PRODUCTS PLANS ARE POSTAGE PAID. SEND CHECK, MO, VISA, MC IN US FUNDS.

INFORMATION UNLIMITED
P.O. BOX 716 DEPT. RE. AMHERST, NH 03031

Have you been kept in the dark?



Let MCM ELECTRONICS "ENLIGHTEN" you, with their huge selection of electronic parts and components.

Many MCM customers have told us that they used to be forced to buy from several parts and components suppliers to get all the items they needed. But after they ordered a copy of our **FREE** 172-page Catalog and discovered that it contained virtually every product they could ever want...at prices that allowed them to improve their service profits substantially...they switched to MCM ELECTRONICS. Our huge inventory of nearly 11,000 items, flexible payment terms and rapid order turnaround can "light up your life," too. So, get your subscription of the MCM ELECTRONICS Catalog today and see what you've been missing!

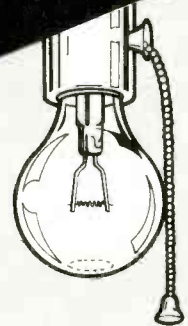

For your **FREE** subscription, call **TOLL-FREE!** 1-800-543-4330



SOURCE NO. RE-56



MCM ELECTRONICS
650 CONGRESS PARK DR.
CENTERVILLE, OH 45459-4072
A PREMIER Company

CIRCLE 87 ON FREE INFORMATION CARD

www.americanradiohistory.com

LASER/PLASMA H.V.PWR SUPPLY * 59⁰⁰
 DIRECT COMPUTER CONTROL OF YOUR LASER/PLASMA GLOBE !! FROM ANY PARALLEL PORT.
 INPUT: 24 VDC
 OUTPUTS: 2 (Laser/plasma)
 LASER: 5.4kv dc, 5ma
 PLASMA GLOBE: 4.5kv ac, 5ma 500hz
 POWER: 4.9 WATTS total
 LASER: 2.7 WATTS
 PLASMA GLOBE: 2.2 WATTS
 SIZE: 6x1.5x2.4 inch
 MODULATION: 100% active low
 FREQ RESPONSE: 900hz full load
 ADJUSTABLE: ±10% of rated
 REGULATION: 1% at full load
 PWM RANGE: 0 to 100% power
 ASSEMBLED AND TESTED! - NOT A KIT
 LASER/PLASMA GLOBE NOT INCLUDED

Radio Electronics Special
 \$10⁰⁰ DISCOUNT ON THE LASER/PLASMA SUPPLY IF YOU SAY "I SAW IT IN RADIO ELECTRONICS"

SQUIRREL-CAGE BLOWERS 9⁰⁰
 PROVIDE LOW NOISE AIR
 12Vdc 2x2x4" #01/03 1.0 Lbs
 115vac 2x2x10" #01/04 1.5 Lbs

TRACTOR MOTORS 80⁰⁰
 PER PAIR 45" EACH
 wheel and tire not included
 GEAR MOTORS WITH 12in. 235 TOOTH OUTPUT GEAR MOVES 3/4 TON FROM 12 VOLT BATTERY #00/06 7Lbs

HASSEL FREE SHOPPING! IF YOU DON'T LIKE IT AND HAVEN'T BROKEN IT, OR HAD IT MORE THAN 15 DAYS RETURN IT FOR A REFUND! Freight is not refundable. Tax and freight extra. Price may change without notice. Limited Qty some items COO to cont. USA. No credit cards, po's, or terms

WE HAVE MOVED
Silicon Valley Surplus OPEN 10am-6pm
 415-261-4506 CLOSED
 4222 E 12TH OAKLAND, CA. 94601 SUN & MON
 CIRCLE 51 ON FREE INFORMATION CARD



SINGERS! REMOVE VOCALS FROM RECORDS AND CDS!

An Unlimited supply of Backgrounds from standard stereo records! Record with your voice or perform live with the backgrounds. Used in Professional Performance yet connects easily to a home component stereo. This unique product is manufactured and sold Exclusively by LT Sound - Not sold through dealers. Call or write for a Free Brochure and Demo Record.

LT Sound, Dept. R-L-3, 7980 LT Parkway
 Lithonia, GA 30058 (404) 482-4724
 Manufactured and Sold Exclusively by LT Sound
 24 HOUR PHONE DEMO LINE: (404) 482-2485

ATTENTION CABLE BROKERS

SURPLUS CATV converters at wholesale prices. UNMODIFIED units only. Oak M35B \$35. (415) 495-3056.

ENGINEERING SOFTWARE

MACINTOSH electronic schematic symbols. Macprint format. Hundreds. \$44.95. OASIS DESIGNS, 61159 El Coyote, Joshua Tree, CA 92252 (619) 366-8570.

BUSINESS OPPORTUNITIES

EASY work! Excellent pay! Assemble products at home. Call for information. (504) 641-8003 Ext. 5192.

MECHANICALLY inclined individuals desiring ownership of small electronics manufacturing business-without investment. Write: BUSINESS-R, C.S. 9008, Baldwin, NY 11510-9008.

IBM monitors repair. Make 75k - 250k, very low initial investment required. Information \$1.00. RAN-DALL, Box 2168 R, Van Nuys, CA 91404.

PROJECTION TV... Make \$\$\$ assembling projectors... easy... results comparable to \$2,500 projectors... Plans, 8" lens & dealers information \$22.50... Professional systems available... Illustrated catalog free. MACROCOMA 15GIX Main Street, Washington Crossing, PA 18977. Creditcard orders 24HRS. (215) 736-2880.

BIG PROFITS!

Learn VCR cleaning-repair! Prior experience unnecessary. Need only small hand tools, average mechanical ability. Big demand performing VCR cleanings and repairs! Viejo's 400 page TRAINING MANUAL (over 500 photos and illustrations!) and companion VIDEO TRAINING TAPE contains hundreds of REAL-WORLD examples of VCR malfunctions and their repair solutions. Secrets revealed! Also: business tips for your new service business!

Free INFO: call (toll free) 1-800-537-0589 or write to: Viejo Publications, Dept. R-E 3540 Wilshire Blvd., Suite 310, Los Angeles, CA 90010

INVENTORS

INVENTORS! Can you patent and profit from your idea? Call AMERICAN INVENTORS CORPORATION for free information. Over a decade of service (800) 338-5656. In Massachusetts or Canada call (413) 568-3753.

CATALOG OR INFORMATION: (213) 888-8988
 TOLL FREE 1-800-423-3483 OR
 1-800-521-MARK (IN CAL) FOR ORDERS

PAID BY VISA MASTERCARD AMERICAN EXPRESS ONLY
 ORDER BY FAX (213) 888-6868

VIDEO/AUDIO SURROUND SOUND PROCESSOR SM-333

It's a must for every modern family!
 It creates high-quality simulated stereo Surround "Music Field" for most video types CD, LD, Surround Sound Encoding (Dolby, 1600, etc.) This processor employs the most updated IC at its heart. It is also equipped with a "DNR" DYNAMIC NOISE REDUCTION SYSTEM IC made by NATIONAL SEMICONDUCTOR to automatically filter out the annoying noise that is commonly found on tapes and CD disc. In addition, there is six LOW NOISE OP-AMPS and all in one board design, no other external connections connect to the main board.
 Other features include:
 • Continuous Variable Audio Time Delay • Surround Effect & Level Control • Dynamic Noise Reduction System • High output signal (8V MAX) can match with any kind of Main Power Amp. • All metal construction for reliability & durability!
 SPECIFICATIONS:
 Frequency Response: 20Hz-20KHz (± 5dB) • Total Harmonic Distortion: 0.06% 20Hz-20KHz (from channel), <0.25% (surround channel) • Input Signal Voltage: 0.1V-3.5V • Output Voltage: 0.1V-3.5V (from channel), 8V MAX. (surround channel) • Delay Time: 5ms-50ms • Input Impedance: 47K Ohms Power: AC 110V/60Hz • Dimensions: 4 3/16in. (W) x 4 1/16in. (H) x 2 1/16in. (D)
 KIT/ASM. AND TESTED \$72/93

PROFESSIONAL COLOR LIGHT CONTROLLER SM-328

FEATURES:
 1. FOUR GROUPS OF INDEPENDENT OUTPUT SYSTEM (1000V/CH, MA3 4800V/110V/117V) 2. PROFESSIONAL COLOR CONTROL SYSTEM (KEY BOARD TYPE) 3. INDEPENDENT INPUT SIGNAL ADJUSTMENT 4. FOUR GROUPS OF INDEPENDENT DIMMER CONTROL 5. SPEED CONTROL CHASER 6. AUTOMATIC CHASING CONTROL SYSTEM 7. FOUR KINDS OF SPECIAL CHASING PROGRAM 8. COMBINATION OF PROGRAM AND MUSIC CHASING EFFECTS 9. FORWARD/BACKWARD CHASING CONTROL SM-328 color light controller is specialized for ballroom, night club disco and advertisement lighting. It consists with several color control characteristics, which employ professional color control system and keyboard program selection. Therefore, it is capable of producing lighting effects by using chasing program and fluctuating music signal. There are two kinds of lighting effects. The first type is controlled by "music" signal. In order to adjust the brightness of four groups of lightings, each music signal will be separated into high, medium, low A, and low B frequency range. Furthermore, each group of lightings is incorporated with an independent signal adjustment. The second kind is composed of electrical circuits and this is the main part for creating a special lighting effect. It has four chasing programs.
 Dimensions: 14 5/16" x 8 15/16" x 3 3/16"
 Kit/ASM. AND TESTED \$150.00 ONLY

MARK V ELECTRONICS, INC.
 8019, E. SLAUSON AVE.
 MONTEBELLO, CA 90640

SHOWROOM HOURS: (PACIFIC TIME)
 MON.-FRI. 9:30 to 5:00 SAT. 10:00-5:00

0-15V 2A REGULATED DC POWER SUPPLY MW-200/TR200

This regulated DC Power Supply is designed for both professionals and amateurs. It features Short-Circuit Protection System, Over-load Indicator, Output Cutoff Switch, and Adjustable Over-load Protection System. So, it is a must for every laboratory and production line.

NEW for 1990
 SPECIFICATIONS & FEATURES
 Output Voltage: Continuous adjustable from 0 to 15V DC
 Output Current: Continuous adjustable from 0.2A to 2A
 Method of Protection: Current Limited. In case of overvoltage, output voltage will automatically decrease to the minimum.
 Over-load indicator: LED lit up
 Ripple & Noise: Less than 1 mV (without loading)
 Stability of Output Voltage: Less than 10 mV
 Power Requirements: 100 120V/200-220V AC +10%
 Dimensions: 125mm (H) x 187mm (W) x 155mm (D)
 ASSEMBLED AND TESTED \$80.00

HIGH QUALITY PRE-AMPLIFIER WITH 10 BAND EQUALIZER TA-2600
 Kit/ASM. AND TESTED \$90.00

ELECTRONIC ECHO AND REVERBERATION AMPLIFIER TA-2000A
 Kit/ASM. AND TESTED \$93.00/116.80

MULTIFUNCTIONAL LED D.P.M. **FREE GOLD-PLATED EDGE CONNECTOR**
 Kit \$34.50

MEASUREMENT RANGE
 D.C. VOLTAGE: 1mV-1000V
 A.C. VOLTAGE: 1mV-1000V
 DIGITAL THERMOMETER: 0°C-100°C
 D.C. CURRENT: 1µA-2A
 CAPACITOR METER: 1pF-2µF
 DIMENSIONS: 3.314" x 1.718" x 4.4116" ASM AND TESTED & CAL. \$43

DIGITAL VOICE MEMO TA-28 MKII

NEW
 FEATURES:
 • SOLID-STATE RECORD/PLAY BACK.
 • POWER/RECORD LED INDICATOR.
 • 4 BIT ADPCM ALGORITHM.
 • 8 BIT AD/DA CONVERTER.
 • 256K MEMORY CAPACITOR.
 • 8 SEC OR 16 SEC RECORD TIME.
 • SAMPLING FREQUENCY 8KHz OR 4 KHz.
 • INCLUDED CONDENSOR MIC & SPEAKER.
 • BUILT IN LOW PASS FILTER.
 • MORE REALISTIC & CLEARLY.
 • LOW POWER CONSUMPTION.
 • SUPPLY VOLTAGE: 5.6V DC.
 • DIMENSIONS: 3 1/2" x 2 3/4" x 1 1/2"
 ** FREE 256K TOY GRADE D-RAM
 KIT/ASM & TESTED \$30/40

8 Digit 1GHz Multifunctional Counter FC-1000A
 KIT/ASM & TESTED \$192.00

LAB. QUALITY AT A BREAKTHROUGH PRICE!
 FEATURES:
 Frequency: 10Hz-1GHz GUARANTEED, 5Hz 120Hz (typical)
 Input sensitivity: 10mV-100mV (10mV 32mV)
 100mV ± 2% (5mV 25mV)
 Period range: 0.8-108
 Line counting: accuracy: 99999999
 Accuracy: ± 10ppm 5 time base accuracy
 Hold function: Hold the last input signal (Max 8 digit)
 Power source: 117V AC ± 10% 50-60Hz
 Dimensions: 8.8" (W) x 8.0" (H) x 1.0" (D) KIT/ASM AND TESTED & CAL. \$192.00

120W MOSFET POWER AMPLIFIER TA-477
 BUILD A PROFESSIONAL AMP BY YOURSELF
 KIT \$88.00
 Metal Cabinet/Transformer (Optional) \$33.00/24.00

This amplifier consists of three super low TIM differential stages, and Hitachi 2S149/2SK 134 match pair "MOSFET" as output component whose frequency response and transient response is superior to the other power transistor. Therefore this amplifier has high-fidelity and superior analytic power over the entire Audio Spectrum. It is suitable for reproducing classic and modern music. Heavy Duty Heat Sink with 28 radial fins is included!
 Kit \$88.00
 Metal Cabinet/Transformer (Optional) \$33.00/24.00
 TERMS: \$10 min order • \$20 min charge card order • Check, money order or phone order accepted • We ship UPS ground • Add 10% of total order (min \$2.5) for shipping outside USA and 20% (min \$5.00) • Transit Insurance, and 5% of total (outside USA only) • CA residents add sales tax • All merchandise subject to prior sale • Prices are subject to change without notice • Any goods proved to be defective MUST BE RETURNED IN ORIGINAL FORM WITH A COPY OF YOUR INVOICE WITHIN 30 DAYS FOR REPLACEMENT.

BEAUTY AND SILICON BEAST

MONSTER bi-color LED, 12 flashing elements in 3" dome, \$12. Touch switch, stays on so long as in skin contact, 200ma, \$4.90. Sound activated switch, 10ua standby current, panel mountable, \$6.90. Mini DC converters: input 3v (DD3510) or 9v (DD9510), output 5.5v, 100ma. @\$5.90. 10% off 3 devices up, instructions included, postpaid, guaranteed. **PARAWING**, P.O. Box 65, Menlo Park, CA 94026.

SCRAMBLE FACTS 718-343-0130

PHONE TODAY for 3 minutes of satellite TV industry news, technical tips, and new product information.

CABLE-TV AT IT'S BEST

SCIENTIFIC Atlanta models 8500-8550-8580 remote included... \$275.00. SB-3's... \$74.00. TRI-BI's... \$95.00. SA-3's... \$99.00. Zenith (Z-Tac) descramblers... \$169.00. M-12 (Vari-sync)... \$89.00. M-35 B (Vari-sync)... \$99.00. Hamlin MLD-1200's... \$89.00. 80-Channel converters... \$95.00. Dealer discount on (5) units. Call—N.A.S. INTERNATIONAL, (213) 631-3552.

WANTED

INVENTORS! AIM wants - Ideas, inventions, technology, improvements on existing products. We submit ideas to manufacturers. Confidentiality guaranteed. Call toll-free in U.S. and Canada 1 (800) 225-5800.

Cable TV Converters

Why Pay A High Monthly Fee?

Jerrold Products include "New Jerrold Tri-Mode," SB-3. Hamlin, Oak VN-12, M-35-B, Zenith, Magnavox, Scientific Atlanta, and more. (Quantity discounts) 60 day warranty. For fast service C.O.D. orders accepted. Send SASE (60 cents postage) or call for info 1-800-648-3030. **MIDWEST ELECTRONICS, INC.**, 5143-R W. Diversey, Chicago, IL 60639. MC/Visa orders accepted. No Illinois orders accepted. Mon.-Fri. 8 A.M.-5 P.M. CST

DESCRAMBLER MODULE

LATEST technology alternative to Jerrold SB-3 or Radio-Electronics Feb. 1984 project. Featuring electronic tuning, AGC, auto-on/off, AC/DC power, mini-size, A&T, and more. For literature—**SOUTHTECH DISTRIBUTING**, (813) 527-2190.

BIG PROFITS

ELECTRONIC ASSEMBLY BUSINESS

Start home, spare time. Investment knowledge or experience unnecessary. BIG DEMAND assembling electronic devices. Sales demanded by professionals. Unusual business opportunity.

FREE: Complete illustrated literature
BARTA, RE-O Box 248
Walnut Creek, Calif. 94597

CONSOLIDATED ELECTRONICS



CONSUMER & INDUSTRIAL ELECTRONICS CATALOG • 17TH EDITION

THE ULTIMATE ELECTRONICS CATALOG.

Order your 260 page catalogue packed with over 10,000 money saving electronic parts and equipment. Send \$3.00 check or money order, or call **1-800-543-3568** today and use your Mastercard or Visa.
Consolidated Electronics, Incorporated
705 Watervliet Ave., Dayton, Ohio 45420-2599

NAME _____
ADDRESS _____
CITY _____
STATE _____ ZIP _____

CIRCLE 70 ON FREE INFORMATION CARD

WALNUT SPEAKER CABINET KIT

Super quality, genuine walnut veneer cabinet. Kit includes: routed and mitred top, sides, and bottom in unfinished 3/4" walnut veneer. Cut your own custom holes in the front and rear to match your drivers. 15" x 24" x 11". Volume: 1.9 cu. ft.



#260-350 \$22.50 \$19.95
(1-3) (4-up)

15" THRUSTER WOOFER

Thruster by Eminence. Made in U.S.A. Forward poly roll foam surround, 56 oz. magnet. 2-1/2", 2 layer voice coil. 150 watts RMS, 210 watts max. 4 ohm. fs = 23.5 Hz, QMS = 9.86, QES = .34, QTS = .33, VAS = 17.9 cu. ft. SPL = 94.8 dB 1W/1M. Net weight: 15 lbs.



#290-180 \$43.50 \$39.80
(1-3) (4-up)

SUBWOOFER CROSSOVER

200 watts RMS.
12 dB per octave.
150 Hz at 8 ohm crossover point.



#260-220 \$28.80 \$24.40
(1-5) (6-up)

SPEAKERS AND COMPONENTS



EMINENCE



12" POLY WOOFER



Super duty, 40 oz. magnet. Polypropylene cone. 100 watts RMS, 145 watts max. 4 and 8 ohm compatible (6 ohm). 2" voice coil. fs = 25 Hz. VAS = 10.8 cu. ft., QTS = .166. Response: 25-1,500 Hz. Net weight: 9 lbs.

#290-125 \$36.80 \$34.50
(1-3) (4-up)

12" PIONEER SUB WOOFER



Dual voice coil sub woofer. 30 oz. magnet, 2" voice coil. 100 watts RMS, 145 watts max. fs = 25 Hz. 6 ohm (4 and 8 ohm compatible). SPL = 89 dB 1W/1M. Response: 25-700 Hz. QTS = .31, VAS = 10.3 cu. ft. Pioneer #A30GU30-55D. Net weight: 6 lbs.

#290-145 \$39.80 \$36.80
(1-3) (4-up)

15" 3-WAY, 125 WATT SYSTEM

Our "Top-of-the-Line" system. The system features elements specifically selected to produce a balanced output throughout the full frequency bandwidth of the system. System includes: (1) #290-155 15" polypropylene woofer rated at 145 watts max. (2) #280-020 cup midranges, (1) #270 035 4" soft dome tweeter, (1) #260-215 200 watt 3-way crossover, (2) #260-265 100 watt mid, tweeter "L" pad attenuators, (1) #260-300 speaker terminal, and (1) #260-340 grille cloth.



#15-125

\$99.95
Each

18" EMINENCE WOOFER

EMINENCE



MADE IN U.S.A.

100 oz. magnet, 3" voice coil. 250 watts RMS, 350 watts max. 8 ohm, 30 Hz resonant frequency. 22-2700 Hz response. Efficiency: 95 dB 1W/1M. Paper cone treated accordian surround. Net weight: 29 lbs.

#290-200 \$98.80 \$89.50
(1-3) (4-up)

PIONEER HORN TWEETER

Mylar dome, 2.93 oz. barium ferrite magnet. 8 ohm. Response: 1,800-20,000 Hz. 35W RMS, 50W max. fs = 2,000 Hz, SPL = 106 dB. Pioneer #AHE80-51F.



#270-050 \$6.50 \$5.90
(1-9) (10-up)

3-WAY 100W CROSS-OVER

12 dB / octave rolloff. 800 Hz, 5000 Hz. 8 ohm. 100 watts RMS.



#260-210 \$12.50 \$9.95
(1-9) (10-up)

Parts Express
INTERNATIONAL

340 E. First St., Dayton, OH 45402
Local 1-513-222-0173
FAX 513 222-4644

**CALL
TOLL FREE
1-800-338-0531**

* 15 day money back guarantee. * \$10.00 minimum order. * We accept Mastercard, Visa, Discover, and C.O.D. orders. * 24 hour shipping. * Shipping charge = UPS chart rate (\$2.50 minimum charge). * Hours: 8:30 am - 6:00 pm EST, Monday - Friday. * Mail order customers, please call for shipping estimate on orders exceeding 5 lbs.



**FREE
CATALOG**

CIRCLE 56 ON FREE INFORMATION CARD

www.americanradiohistory.com

| INTEGRATED CIRCUITS | | | INTEGRATED CIRCUITS | | | SILICON TRANSISTORS | | | 1% METAL OXIDE FILM RESISTORS | | | DISC CAPACITORS | | | PANASONIC V SERIES | | | | | | | | | | | | | | | | | | | | | | | | | | | | | | | | | | | | | | | | | | | | | | | | | | | | | | | | | | | | | | | | | | | | | | | | | | | | | | | | | | | | | | | | | | | | | | | | | | | | | | | | | | | | | | | | | | | | | | | | | | | | | | | | | | | | | | | | | | | | | | | | | | | | | | | | | | | | | | | | | | | | | | | | | | | | | | | | | | | | | | | | | | | |
|---------------------|-------|-------|---------------------|-------|-------|---------------------|-------|-------|-------------------------------|-------|-------|-----------------|-------|-------|--------------------|-------|-------|-------|-------|-------|-------|-------|-------|-------|-------|-------|-------|-------|-------|-------|-------|-------|-------|-------|-------|-------|-------|-------|-------|-------|-------|-------|-------|-------|-------|-------|-------|-------|-------|-------|-------|-------|-------|-------|-------|-------|-------|-------|-------|-------|-------|-------|-------|-------|-------|-------|-------|-------|-------|-------|-------|-------|-------|-------|-------|-------|-------|-------|-------|-------|-------|-------|-------|-------|-------|-------|-------|-------|-------|-------|-------|-------|-------|-------|-------|-------|-------|-------|-------|-------|-------|-------|-------|-------|-------|-------|-------|-------|-------|-------|-------|-------|-------|-------|-------|-------|-------|-------|-------|-------|-------|-------|-------|-------|-------|-------|-------|-------|-------|-------|-------|-------|-------|-------|-------|-------|-------|-------|-------|-------|-------|-------|-------|-------|-------|-------|-------|-------|-------|-------|-------|-------|-------|-------|-------|-------|-------|-------|-------|-------|-------|-------|-------|-------|-------|-------|-------|-------|-------|-------|-------|-------|-------|-------|-------|-------|-------|-------|-------|-------|-------|-------|-------|-------|-------|-------|-------|-------|-------|-------|-------|-------|-------|-------|-------|-------|-------|-------|-------|-------|-------|-------|
| 7400 TTL | 7400N | 7400P | 7401N | 7401P | 7402N | 7402P | 7403N | 7403P | 7404N | 7404P | 7405N | 7405P | 7406N | 7406P | 7407N | 7407P | 7408N | 7408P | 7409N | 7409P | 7410N | 7410P | 7411N | 7411P | 7412N | 7412P | 7413N | 7413P | 7414N | 7414P | 7415N | 7415P | 7416N | 7416P | 7417N | 7417P | 7418N | 7418P | 7419N | 7419P | 7420N | 7420P | 7421N | 7421P | 7422N | 7422P | 7423N | 7423P | 7424N | 7424P | 7425N | 7425P | 7426N | 7426P | 7427N | 7427P | 7428N | 7428P | 7429N | 7429P | 7430N | 7430P | 7431N | 7431P | 7432N | 7432P | 7433N | 7433P | 7434N | 7434P | 7435N | 7435P | 7436N | 7436P | 7437N | 7437P | 7438N | 7438P | 7439N | 7439P | 7440N | 7440P | 7441N | 7441P | 7442N | 7442P | 7443N | 7443P | 7444N | 7444P | 7445N | 7445P | 7446N | 7446P | 7447N | 7447P | 7448N | 7448P | 7449N | 7449P | 7450N | 7450P | 7451N | 7451P | 7452N | 7452P | 7453N | 7453P | 7454N | 7454P | 7455N | 7455P | 7456N | 7456P | 7457N | 7457P | 7458N | 7458P | 7459N | 7459P | 7460N | 7460P | 7461N | 7461P | 7462N | 7462P | 7463N | 7463P | 7464N | 7464P | 7465N | 7465P | 7466N | 7466P | 7467N | 7467P | 7468N | 7468P | 7469N | 7469P | 7470N | 7470P | 7471N | 7471P | 7472N | 7472P | 7473N | 7473P | 7474N | 7474P | 7475N | 7475P | 7476N | 7476P | 7477N | 7477P | 7478N | 7478P | 7479N | 7479P | 7480N | 7480P | 7481N | 7481P | 7482N | 7482P | 7483N | 7483P | 7484N | 7484P | 7485N | 7485P | 7486N | 7486P | 7487N | 7487P | 7488N | 7488P | 7489N | 7489P | 7490N | 7490P | 7491N | 7491P | 7492N | 7492P | 7493N | 7493P | 7494N | 7494P | 7495N | 7495P | 7496N | 7496P | 7497N | 7497P | 7498N | 7498P | 7499N | 7499P | 7500N | 7500P |

Circle 82 on Free Information Card

www.americanradiohistory.com

| SERVICE CHARGES | | VOLUME DISCOUNT | |
|-----------------|-----------|------------------|----------|
| \$ 0.00-\$24.99 | +\$3.00 | \$ 0.00-\$9.99 | NET |
| \$25.00 and Up | No Charge | \$ 10.00-\$24.99 | Less 10% |
| | | \$ 25.00-\$49.99 | Less 15% |
| | | \$ 50.00-\$99.99 | Less 20% |
| | | \$ 100.00 & Up | Less 25% |

Spring Specials from Heath

Kit projects...

Heathkit Flood Alarm detects unwanted water Avert damage from leaking water pipes or basement wall seepage. Three hours to build. Needs 9V battery. 13 1/4" H x 3 3/8" W x 4 7/8" L. Kit GD-1701 (2 lbs.) ... **\$12.95**



Program your doorbell with a favorite tune

Arrange wire leads on one-octave keyboard inside doorbell to program any tune. Includes songbook with 50+ college, seasonal, Christmas and special occasion songs. Back door button activates a part-tune. Volume, tone, speed and delay adjustable. Two-evening kit. Takes standard 16 VAC, 50/60 Hz bell transformer. Kit TD-1089 (3 lbs.) ... **\$32.95**

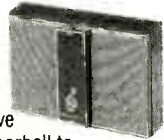

Build your own Heathkit draft detector

Easily detect heat loss areas. Turn it on, adjust for silence, then move sensor in areas where heating or cooling losses occur. Temperature changes set off beeping alarm and flashing LED. Used in temperatures from 59-95F. Takes a 9-volt battery (not included). Kit NE-2112 (2 lbs.) ... **\$14.95**



Heathkit Furnace Air Cleaner.

Works with heating or A/C system to reduce the effects of pollen, dust and cigarette smoke. Power supply mounts onto a cold air duct, and turns on collecting cell when blower is running. 1" collecting cells below directly replace original furnace filter. 120VAC also works with GD-2196 2" filters. Kit GD-3196 (9 lbs.) **\$79.95**
Accessory filters 4 sizes available. each ... **\$74.95**



Heathkit Portable Air Cleaner.

Helps solve tough air-cleaning problems, removes dust, smoke, other pollutants from 6,000 cubic feet (25' x 30' x 8' room). One-evening kit includes power supply, 3-speed fan control and assembled filter. 120 VAC, 60 Hz. Dimensions 26 1/2" H x 17 1/4" W x 13 1/2" D. Kit GDS-1297 (59 lbs.) ... **\$199.00**
Accessory: Replacement Charcoal Filter Assd. GDA-1297-2 (2 lbs.) **\$9.95**



Charging system tester

Diagnose faulty components in your car's charging system with accuracy and ease. A two-wire setup and three quick tests show you if the battery has sufficient charge to reliably start the engine, if the battery is being charged by the alternator, if the voltage regulator is faulty (causing the battery to become overcharged), or if the alternator stator windings and rectifier diodes are functioning properly. No external power or battery required. Dimensions are 5 1/2" H x 2 3/4" W x 3/4" D. Kit CI-2065 (2 lbs.) ... **\$19.95**

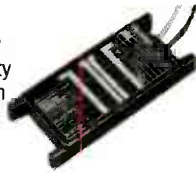

Noise generator kit

To properly check out any stereo or sound system with a spectrum analyzer, you need a noise source with a nearly constant energy output. This one-evening Pink/White Noise Generator will do just that... and at a fraction of the cost of comparable noise generators. Kit AD-1309 (2 lbs.) ... **\$24.95**



For the electronic hobbyist...

Pocket-size digital meter for home and shop Compact digital meter includes 3 1/2 digit, LCD display for readings up to 1999, audible continuity checker and diode test. Overload protected on all ranges, new transistor hFE test. Assd. SM-2310 (1 lb.) Now only **\$24.95**



Connector adapter kit

Make 108 different coaxial connector adapters with gold-plated pins and Teflon insulation. Kit contains male and female, N, BNC, UHF, SMA TNC and mini UHF connectors. Special in-between fittings allow you to assemble your own adapters in seconds. Assd. HCA-3000 (2 lbs.) ... **\$69.95**



Coax adapter cables

Solve frustrating coax connection problems with this convenient adapter cable assortment. Twenty cables in all help you make almost any connection. Two handy



storage racks keep your cables neatly organized. 50 ohm impedance. Assd. TPI-5000 (5 lbs.) . Now **\$49.95**

Unbeatable Scanner Prices...

Uniden 10-Channel/10-Band Handheld Scanner. Save \$31. Superportable, programmable, direct channel access, channel lockout, keyboard lock switch prevents accidental reprogramming. 55 dB @ +25kHz selectivity; audio output 300 milliwatts maximum. Receive 29 to 512 MHz with a 15-channel-per-second scan speed. Requires 5, AA (not included) or rechargeable NiCd batteries. Assd. BC-55X-LT (1 lb.) ... **\$108.88**

100-Channel/11-Band Uniden Handheld scanner. Reduced \$41. 100 programmable channels, 10 scanning banks, 11 bands of coverage. Automatic and manual search, weather search, 10 priority channels, squelch, lockout and delay. Selectivity is -55 dB @ +25kHz; audio output is 450mW maximum. Snap-on battery pack gives full-powered portable scanning. Assd. BC-100X-LT (3 lbs.) ... **\$188.88**

Uniden Tabletop Scanner. 11 bands of coverage, 5 or 15 channels-per-second scanning speed. Features automatic memory search, backup, priority, programmable lockout, scan speed control and automatic squelch setting. Selectivity -45 dB @ +25 kHz, audio output one watt at 10% THD. Takes 117 VAC, 60 Hz from an external wall outlet. Originally priced at \$169.95. Assd. BC-175X-L (3 lbs.) ... **\$148.88**

100 Channel/11-Band Uniden Mobile scanner. Auto search aircraft, police, marine and emergency bands. Fully programmable. Fits neatly under dash, flip-down stand and telescopic antenna included. Audio output is 1.5 watts at 10% THD; require 13.8 VDC (vehicle battery or AC adapter). Save \$61+. Assd. BC-580X-LT (5 lbs.) ... **\$198.88**

Deluxe Uniden Mobile Scanner. Save \$81+. 100-channel/12-band mobile scanner. Covers 800 MHz band for full 12-channel coverage. Weather search, priority, squelch, lockout, delay, auto and manual band search. Mount under dash, or AC adapter (included), flip-down stand and telescopic antenna. Takes 13.8 VDC. Assd. BC-760X-LT (5 lbs.) ... **\$248.88**

Make life easier...

Full-featured remote control center for your TV, VCR and CATV

Assd. GDZ-143 (1 lb.) ... **\$29.95**
**Zenith cannot guarantee that the PCC will operate every model TV or VCR.



Recharge your NiCd batteries

Assd. BP-1234 (4 lbs.) ... **\$17.95**

Amber screen fish finder

Assd. MI-2020 (6 lbs.) ... **\$244.95**
Accessories: Transom Mount Transducer Assd. MIA-2020-1 (4 lbs.) ... **\$44.95**
Through-Hull Transducer Assd. MIA-2020-2 (6 lbs.) ... **\$99.95**



Full color fish finder

Assd. MI-2040 (10 lbs.) ... **\$399.00**



Portable weather computer travels in your shirt pocket Save over \$15 on this compact weather instrument that goes with you hiking, biking, boating and camping. Gives time, date and current temperature, plus keeps a record of highest and lowest temperatures. Also acts as a stopwatch. Automatic power-down feature extends battery life. Requires three AAA batteries (not included). Assd. BW-100 (1 lb.) Now only **\$24.95**

Heathkit®

to order CALL TOLL FREE
1-800-253-0570
Use order code 216-020



for credit card orders, 24 hours a day.

Some items are closeouts. All items are available in limited quantities. Prices for some items were previously reduced.

For your free Heathkit catalog call 1-800-44-HEATH.

CIRCLE 86 ON FREE INFORMATION CARD

Mail Order Electronics - Worldwide

Jameco ELECTRONICS

Mail-Order Electronics

24 HOUR ORDER HOTLINE

415-592-8097

IC Clearance Sale!

Expires 5/31/89

NEC V20 & V30 CHIPS

Replace the 8086 or 8088 in Your IBM PC and Increase Its Speed by up to 30%! Price

| | |
|------------------------------|-----------------|
| UPD70108-5 (5MHz) V20 Chip | \$ 7.49 |
| UPD70108-8 (8MHz) V20 Chip | \$10.75 \$ 9.49 |
| UPD70110-10 (10MHz) V20 Chip | \$12.25 \$12.25 |
| UPD70116-8 (8MHz) V30 Chip | \$9.95 \$ 7.95 |
| UPD70116-10 (10MHz) V30 Chip | \$16.95 \$15.49 |

7400

| Part No. | 1-9 | 10+ | Part No. | 1-9 | 10+ |
|----------|------|------|----------|------|------|
| 7400 | SALE | 15 | 7485 | SALE | 45 |
| 7402 | 29 | 19 | 7486 | SALE | 29 |
| 7404 | SALE | 15 | 7489 | 1.95 | 1.85 |
| 7406 | 35 | 25 | 7490 | 49 | 39 |
| 7406 | 39 | 29 | 7493 | 45 | 35 |
| 7407 | SALE | 25 | 74121 | SALE | 25 |
| 7408 | 35 | 25 | 74123 | SALE | 35 |
| 7410 | SALE | 15 | 74125 | SALE | 35 |
| 7414 | SALE | 25 | 74126 | SALE | 35 |
| 7416 | SALE | 19 | 74175 | SALE | 3.95 |
| 7417 | SALE | 19 | 74150 | SALE | 1.10 |
| 7420 | 29 | 19 | 74154 | 1.35 | 1.25 |
| 7430 | SALE | 15 | 74158 | SALE | 1.25 |
| 7432 | 39 | 29 | 74173 | SALE | 59 |
| 7438 | SALE | 25 | 74174 | SALE | 35 |
| 7442 | 29 | 19 | 74175 | SALE | 49 |
| 7445 | SALE | 59 | 74176 | SALE | 49 |
| 7446 | 89 | 79 | 74181 | SALE | 1.49 |
| 7447 | 89 | 79 | 74189 | SALE | 1.49 |
| 7448 | 1.95 | 1.85 | 74193 | 79 | 69 |
| 7472 | SALE | 25 | 74198 | SALE | 1.25 |
| 7473 | 29 | 19 | 74231 | SALE | 69 |
| 7474 | SALE | 25 | 74273 | SALE | 4.49 |
| 7475 | 49 | 39 | 74365 | SALE | 35 |
| 7476 | 45 | 35 | 74367 | SALE | 35 |

74LS

| | | | | | |
|---------|------|------|---------|------|------|
| 74LS00 | SALE | 15 | 74LS165 | 75 | 65 |
| 74LS02 | SALE | 15 | 74LS166 | SALE | 69 |
| 74LS04 | SALE | 16 | 74LS173 | SALE | 25 |
| 74LS05 | SALE | 19 | 74LS174 | SALE | 25 |
| 74LS06 | 59 | 49 | 74LS175 | SALE | 25 |
| 74LS07 | 59 | 49 | 74LS189 | SALE | 2.95 |
| 74LS08 | 28 | 18 | 74LS191 | SALE | 39 |
| 74LS10 | SALE | 15 | 74LS193 | 69 | 59 |
| 74LS14 | SALE | 29 | 74LS221 | SALE | 49 |
| 74LS27 | SALE | 19 | 74LS240 | SALE | 45 |
| 74LS30 | SALE | 15 | 74LS243 | SALE | 45 |
| 74LS32 | SALE | 19 | 74LS244 | SALE | 49 |
| 74LS42 | 49 | 39 | 74LS245 | SALE | 59 |
| 74LS47 | 89 | 79 | 74LS259 | 99 | 89 |
| 74LS73 | SALE | 25 | 74LS273 | 89 | 79 |
| 74LS74 | SALE | 19 | 74LS279 | 49 | 39 |
| 74LS75 | SALE | 25 | 74LS322 | 3.49 | 3.39 |
| 74LS76 | 39 | 29 | 74LS365 | SALE | 35 |
| 74LS85 | 59 | 49 | 74LS366 | SALE | 35 |
| 74LS86 | 29 | 19 | 74LS367 | SALE | 29 |
| 74LS90 | SALE | 29 | 74LS373 | SALE | 35 |
| 74LS93 | 29 | 19 | 74LS374 | SALE | 59 |
| 74LS123 | SALE | 35 | 74LS374 | SALE | 49 |
| 74LS125 | 49 | 39 | 74LS393 | SALE | 69 |
| 74LS138 | 49 | 39 | 74LS590 | 5.95 | 5.85 |
| 74LS139 | SALE | 29 | 74LS624 | 1.95 | 1.85 |
| 74LS154 | 1.19 | 1.09 | 74LS629 | SALE | 1.95 |
| 74LS157 | 45 | 35 | 74LS640 | SALE | 89 |
| 74LS158 | SALE | 25 | 74LS645 | SALE | 89 |
| 74LS163 | SALE | 35 | 74LS670 | SALE | 79 |
| 74LS164 | SALE | 35 | 74LS688 | 2.39 | 2.29 |

74S/PROMS*

| | | | | | |
|--------|------|------|---------|------|------|
| 74S00 | SALE | 19 | 74S188* | 1.49 | |
| 74S04 | SALE | 19 | 74S189 | 1.49 | |
| 74S03 | SALE | 19 | 74S196 | SALE | 1.49 |
| 74S10 | SALE | 19 | 74S240 | SALE | 1.39 |
| 74S32 | SALE | 19 | 74S244 | SALE | 75 |
| 74S74 | SALE | 19 | 74S253 | SALE | 29 |
| 74S85 | SALE | 49 | 74S287* | 1.49 | |
| 74S86 | SALE | 19 | 74S288* | 1.49 | |
| 74S124 | SALE | 1.25 | 74S373 | SALE | 35 |
| 74S174 | SALE | 99 | 74S471 | SALE | 99 |
| 74S175 | SALE | 25 | 74S472* | SALE | 2.49 |

CD-CMOS

| | | | |
|--------|------|----------|------|
| CD4001 | 19 | CD4076 | 59 |
| CD4008 | 59 | CD4081 | 22 |
| CD4011 | 19 | CD4082 | 22 |
| CD4013 | 29 | CD4093 | 35 |
| CD4016 | 49 | CD4094 | 89 |
| CD4017 | 49 | CD40103 | 1.49 |
| CD4018 | 59 | CD40107 | 49 |
| CD4020 | 59 | CD4510 | 69 |
| CD4024 | 45 | CD4511 | 69 |
| CD4027 | 35 | CD4520 | 75 |
| CD4030 | 35 | CD4522 | 35 |
| CD4040 | 65 | CD4538 | 79 |
| CD4049 | 29 | CD4541 | 89 |
| CD4050 | 29 | CD4543 | 79 |
| CD4051 | 59 | CD4553 | 3.95 |
| CD4052 | 59 | CD4555 | 79 |
| CD4053 | 59 | CD4559 | 7.95 |
| CD4063 | 1.49 | CD4566 | 1.95 |
| CD4066 | 29 | CD4568 | 59 |
| CD4067 | 1.49 | CD4584 | 49 |
| CD4069 | 19 | CD4585 | 69 |
| CD4071 | 22 | MC14411P | 7.95 |
| CD4072 | 22 | MC14490P | 4.49 |

EEPROMS

| | | | | |
|----------|--------|---------------|------------------------------|-------|
| 2816A | 2048x8 | 350ns (W 15V) | 5V Read/Write | 5.25 |
| 2816A-25 | 2048x8 | 250ns (W 15V) | 5V Read/Write | 5.49 |
| 2817A | 2048x8 | 350ns (W 15V) | 5V Read/Write | 5.95 |
| 2864A | 8192x8 | 250ns (W 15V) | 5V Read/Write (Pm 1, No R/W) | 13.95 |
| 2864A-30 | 8192x8 | 300ns (W 15V) | 5V Read/Write (Pm 1, No R/W) | 12.95 |
| 2865A-30 | 8192x8 | 300ns (W 15V) | 5V Read/Write | 9.95 |
| 52B13 | 2048x8 | 350ns (21V) | 5V Read Only | 1.49 |

MICROPROCESSOR COMPONENTS

MISCELLANEOUS CHIPS

| Part No. | Price | 8000 SERIES Continued | Price |
|------------|-----------|-----------------------|-----------|
| D765AC | 3.95 2.95 | 8087 (5MHz) | 99.95 |
| WD9216 | 3.95 | 8087-1(10MHz) | 194.95 |
| Z80 | 1.19 | 8087-2(8MHz) | 139.95 |
| Z80A-CTC | 1.99 | 8088 (5MHz) | 4.95 3.49 |
| Z80A-PI0 | 1.99 | 8088-2(8MHz) | 5.95 3.95 |
| Z80A | 1.29 | 8116 | 4.95 3.95 |
| Z80A-CTC | 1.65 | 8155 | 2.49 |
| Z80A-PI0 | 1.99 | 8156 | 2.95 |
| Z80A-SIO/O | 3.95 2.95 | 8212 | 2.29 |
| Z80B | 2.75 | 8228 | 2.49 |
| Z80B-CTC | 3.95 3.25 | 8237-5 | 4.95 3.95 |
| Z80B-PI0 | 4.95 | 8243 | 1.75 |
| Z8530 | 4.95 | 8250A | 4.95 3.95 |
| Z8671 | 7.95 | 8251A | 1.69 |
| Z8681B1 | 8.95 | 8253-5 | 1.95 |

| Part No. | Price | 8000 SERIES Continued | Price |
|-------------|-----------|-----------------------|-------------|
| 8031 | 3.95 3.49 | 8254 | 3.95 |
| 80C31 | 3.95 3.95 | 8255A-5 | 2.95 |
| 8035 | 1.49 1.25 | 8259-5 | 2.25 1.75 |
| 8039 | 1.95 1.59 | 8272 | 3.95 2.95 |
| 8052AHBASIC | 24.95 | 8279-5 | 9.95 2.75 |
| 8085A | 2.49 | 8741 | 9.95 |
| 8086 | 3.95 | 8742 | 19.95 17.95 |
| 8086-2 | 6.95 4.49 | 8748 (25V) | 7.95 |

STATIC RAMS

| Part No. | Function | Price |
|-------------|---------------------------------|------------|
| 2016-12 | 2048x8 120ns | 4.95 3.75 |
| 2018-45 | 2048x8 45ns 300MIL | 6.95 |
| 2102 | 1024x1 350ns | 89 |
| 2114N | 1024x4 450ns | 99 79 |
| 2114N-2L | 1024x4 200ns Low Power | 1.49 |
| 21C14 | 1024x4 200ns (CMOS) | 2.95 |
| 5101 | 256x4 450ns (CMOS) | 6.95 4.95 |
| 6116P-1 | 2048x8 150ns (16K) CMOS | 6.49 4.39 |
| 6116P-3 | 2048x8 150ns (16K) LP CMOS | 5.99 3.99 |
| 6116P-3S | 2048x8 150ns (16K) CMOS | 5.99 3.95 |
| 6264P-15 | 8192x8 100ns (64K) CMOS | 10.49 9.95 |
| 6264P-15 | 8192x8 100ns (64K) LP CMOS | 10.49 9.95 |
| 6264P-12 | 8192x8 120ns (64K) LP CMOS | 10.49 9.95 |
| 6264P-15 | 8192x8 150ns (64K) LP CMOS | 10.25 9.49 |
| 6514 | 1024x4 350ns (CMOS) | 3.95 3.49 |
| 43256-10L | 32,768x8 100ns (256K) Low Power | 20.95 |
| 43256-15L | 32,768x8 150ns (256K) Low Power | 13.95 |
| 62256LP-P5 | 32,768x8 85ns (256K) LP CMOS | 22.95 |
| 62256LP-P10 | 32,768x8 100ns (256K) LP CMOS | 21.95 |
| 62256LP-P12 | 32,768x8 120ns (256K) LP CMOS | 20.95 |

DYNAMIC RAMS

| | | |
|-------------|------------------------------|--------------|
| THM1000L-10 | 1,048,576x9 100ns 1Megx9 SIP | 399.95 |
| THM1000S-10 | 1,048,576x9 100ns 1Megx9 SIM | 399.95 |
| THM1000L-80 | 1,048,576x8 80ns 1Megx9 SIP | 419.95 |
| THM1000S-80 | 1,048,576x8 80ns 1Megx9 SIM | 419.95 |
| TMS4416-12 | 16,384x4 120ns | 7.75 6.75 |
| TMS4416-15 | 16,384x4 150ns | 7.75 6.75 |
| 4116-15 | 16,384x4 150ns (MM5290N-2) | 1.39 1.25 |
| 4126-15 | 131,072x1 100ns (Piggyback) | 5.29 |
| 4164-100 | 65,536x1 100ns | 3.49 |
| 4164-120 | 65,536x1 120ns | 2.95 |
| 4164-150 | 65,536x1 150ns | 2.59 |
| 41256-60 | 262,144x1 60ns | 14.49 |
| 41256-80 | 262,144x1 80ns | 12.49 |
| 41256-100 | 262,144x1 100ns | 11.95 |
| 41256-120 | 262,144x1 120ns | 11.49 |
| 41256-150 | 262,144x1 150ns | 11.95 |
| 41264-12 | 64Kx4 120ns Video RAM | 19.95 |
| 41464-10 | 65,536x4 100ns (1Meg) | 13.95 |
| 41464-12 | 65,536x4 120ns (1Meg) | 13.95 |
| 41464-15 | 65,536x4 150ns (1Meg) | 13.95 |
| 41256-10P | 262,144x9 100ns 256Kx9 SIP | 149.95 |
| 85256-09S | 262,144x9 100ns 256Kx9 SIM | 149.95 |
| 511000P-10 | 1,048,576x10 (1 Meg) | 399.95 41.95 |
| 511000P-8S | 1,048,576x8 (1 Meg) | 44.95 41.95 |
| 514256P-10 | 262,144x4 100ns (1 Meg) | 59.95 44.95 |

EPROMS

| | | |
|----------|------------------------------|-----------|
| TMS2516 | 2048x8 450ns (25V) | 6.95 5.95 |
| TMS2532 | 4096x8 450ns (25V) | 5.95 4.95 |
| TMS2532A | 4096x8 450ns (12.5V) | 4.49 3.25 |
| TMS2564 | 8192x8 450ns (25V) | 6.95 4.95 |
| TMS2716 | 2048x8 450ns (-5V, +5, +12V) | 6.95 4.49 |
| 1702A | 256x8 (1Meg) | 3.95 |
| 2716 | 2048x8 450ns (25V) | 3.75 |
| 2716-1 | 2048x8 350ns (25V) | 4.25 3.75 |
| 2716-2 | 2048x8 450ns (25V) CMOS | 4.95 3.75 |
| 2732 | 4096x8 450ns (25V) | 3.95 |
| 2732A-20 | 200ns (21V) | 4.25 |
| 2732A-25 | 4096x8 250ns (21V) | 3.95 |
| 2764-25 | 4096x8 450ns (25V) CMOS | 4.95 4.25 |
| 2764-25 | 8192x8 250ns (21V) | 4.25 |
| 2764-25 | 8192x8 450ns (21V) | 3.59 |
| 2764-25 | 8192x8 450ns (12.5V) | 3.69 |
| 2764-25 | 8192x8 450ns (12.5V) CMOS | 3.95 4.49 |
| 27128-20 | 16,384x8 200ns (21V) | 5.95 4.49 |
| 27128-25 | 16,384x8 250ns (21V) | 5.95 |
| 27128-25 | 16,384x8 250ns (12.5V) | 7.75 |
| 27128-25 | 16,384x8 250ns (12.5V) CMOS | 5.95 4.95 |
| | | |

Now Available...Jameco's NEW Winter/Spring Flyer #138 with 48 pages of Computer Peripherals, Components & More!

15th ANNIVERSARY YEAR 1974 - 1989

TEST EQUIPMENT

Metex Digital Multimeters

Metex General Specs:
 • Handheld, high accuracy
 • AC/DC Voltage, AC/DC Current, Resistance, Diodes, Continuity, Transistor hFE • Manual ranging w/overload protection
M3650/B & M4650 only:
 • Also measures frequency and capacitance
M4650 only:
 • Data Hold Switch
 • 4.5 Digit



M4650 Pictured

| | | |
|--------|--|---------|
| M3610 | 3.5 Digit Multimeter..... | \$49.95 |
| M3650 | 3.5 Digit w/Freq. & Capacitance..... | \$69.95 |
| M3650B | Same as M3650 w/Bargraph..... | \$79.95 |
| M4650 | 4.5 Digit w/Freq., Capacitance and Data Hold Switch..... | \$99.95 |

Metex Autoranging Jumbo Readout DMM

• AC/DC Voltage, AC/DC Current, Resistance, Diodes, Continuity and Frequency
 • 3.75 Digit (.8" High)
 • Ruggedized, Water-resistant case
 • Easy-to-use pushbutton switches



M80.....\$59.95

Logic Pulser and Logic Monitor Ideal for inspecting and repair of Logic Circuits

Logic Pulser (LP540):
 • Generates "one-shot" pulse or continuous 5Hz pulse train
 • Pulse repetition rate: 0.5pps/400pps • Audible tone • Compatible with: TTL, DTL, RTL, HTL, HINIL, MOS and CMOS Logic

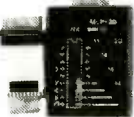

LM20 Pictured

Logic Monitor (LM20):
 • Tests 14 through 20 pin ICs • Detachable, heavy-duty spring clip • LED on or off indicates high or low level

| | | |
|-------|--------------------|---------|
| LP540 | Logic Pulser..... | \$19.95 |
| LM20 | Logic Monitor..... | \$49.95 |

Oscilloscope Probes

• Attenuation: x1 / x10
 • Capacitance (LF180): 180pF / 22pF; (LF210): 40pF / 17pF



LF180 Pictured

| | | |
|-------|--------------------------------|---------|
| LF180 | 40MHz Oscilloscope Probe..... | \$19.95 |
| LF210 | 100MHz Oscilloscope Probe..... | \$29.95 |

Digital Logic Probes

• High, low and pulse indication
 • 20MHz and 50MHz versions available
 • Circuit powered w/ over/undervoltage indicators



PRB20 Pictured

| | | |
|--------|--------------------------------|---------|
| PRB20 | 20MHz Logic Probe..... | \$26.95 |
| PRB20A | 20MHz Audible Logic Probe..... | \$33.95 |
| PRB50 | 50MHz Logic Probe..... | \$47.95 |

RS232 Tester and Breakout Box Make Your Own Custom Cables!

• Complete cable breakout and reconfiguration exists with 24 in-line switches and 54 in-line machine tool sockets • Bi-color LEDs tell you if a line is hi, low or off • Male to female DB25 pin connectors • Includes device wiring chart



MLA1.....\$29.95

Jameco IBM PC/XT 8MHz Turbo Compatible Kit With 256K RAM

- Free! QAPLUS Diagnostic Software Included!
- Free! PC Write Word Processing Software Included!
- 256K RAM Included, Expandable to 640K
- AMI BIOS ROMs Included
- 4.77 or 8MHz Operation
- Regular \$628.01 value for only \$499.95!
- Flip-Top Case w/150 Watt Power Supply
- 360K Disk Drive
- Parallel Printer Port
- 84-Key Keyboard
- Monochrome Amber Monitor



JE3002 IBM Compatible PC/XT 8MHz Turbo Kit.....\$499.95
EZDOS Digital Research MS/PC-DOS Comp. Operating System...\$49.95
EZDOSP Same as above with TrueBASIC.....\$69.95

IBM COMPATIBLE DISPLAY MONITORS

| | | |
|---------|-----------------------|----------|
| AMBER | 12" Amber Mono. | \$99.95 |
| CTX2410 | 14" RGB 640x200 | \$279.95 |
| TM5154 | EGA 14" 720x350 | \$399.95 |
| JE1059 | EGA Monitor & Card | \$519.95 |
| TM5155 | 14" Multiscan 800x560 | \$499.95 |
| QC1478 | 14" VGA 720x480 | \$449.95 |
| JE2055 | VGA Monitor & Card | \$649.95 |



QC1478 Pictured

JAMECO IBM PC/XT/AT COMPATIBLE CARDS

| | | |
|--------|---|----------|
| JE1050 | Monochrome Graphics Card w/Parallel Printer Port (PC/XT/AT)..... | \$59.95 |
| JE1052 | Color Graphics Card w/Parallel Printer Port (PC/XT/AT)..... | \$49.95 |
| JE1055 | EGA Card w/256K Video RAM (PC/XT/AT)..... | \$159.95 |
| JE1071 | Multi I/O Card w/Controller & Monochrome Graphics (PC/XT)..... | \$119.95 |
| JE1060 | I/O Card w/Serial Game, Printer Port & Real Time Clock (PC/XT)..... | \$59.95 |
| JE1061 | RS232 Serial Half Card (PC/XT)..... | \$29.95 |
| JE1062 | RS232 Serial Half Card (AT)..... | \$34.95 |
| JE1065 | I/O Card w/Serial, Game and Parallel Printer Port (AT)..... | \$59.95 |
| JE1081 | 2MB Expanded or Extended Memory Card (zero-K on-board) (AT)..... | \$119.95 |
| JE1041 | 20/40MB Hard Disk Controller Card (PC/XT)..... | \$79.95 |
| JE1043 | 360K/720K/1.2MB/1.44MB Floppy Disk Controller Card (PC/XT/AT)..... | \$49.95 |
| JE1044 | 360K Floppy/Hard Disk Controller Card (PC/XT)..... | \$129.95 |
| JE1045 | 360K/720K/1.2MB/1.44MB Floppy/Hard Disk Controller Card (AT)..... | \$149.95 |

SEAGATE HALF-HEIGHT HARD DISK DRIVES

| | | |
|---------|----------------------------|----------|
| ST225 | 20MB Drive only (PC/XT/AT) | \$224.95 |
| ST225XT | 20MB w/Controller (PC/XT) | \$269.95 |
| ST225AT | 20MB w/Controller (AT) | \$339.95 |
| ST238 | 30MB Drive only (PC/XT/AT) | \$249.95 |
| ST238XT | 30MB w/Controller (PC/XT) | \$299.95 |
| ST238AT | 30MB w/Controller (AT) | \$389.95 |



ST225XT Pictured

Seagate 40MB and 60MB Hard Disk Drives Also Available!

IBM PC/XT/AT COMPATIBLE MOTHERBOARDS

| | | |
|--------|----------------------------|-----------|
| JE1001 | 4.77/8MHz (PC/XT) | \$89.95 |
| JE1002 | 4.77/10MHz (PC/XT) | \$109.95 |
| JE3005 | Baby 8" 12MHz (AT) | \$329.95 |
| JE3010 | Baby 8" 16MHz NEAT (AT) | \$469.95 |
| JE3020 | Baby 16MHz 80386 (AT) | \$1199.95 |
| JE3025 | Baby 20MHz 80386 (AT) | \$1499.95 |
| JE3026 | Full-Size 25MHz 80386 (AT) | \$2299.95 |



JE3025 Pictured

IBM PC/XT/AT COMPATIBLE 3.5"/5.25" DISK DRIVES

| | | |
|--------|------------------------------|----------|
| 352KU | 3.5" 720KB (PC/XT/AT) | \$109.95 |
| 356KU | 3.5" 1.44MB (PC/XT/AT) | \$129.95 |
| JE1020 | 5.25" 360KB (PC/XT/AT) Black | \$89.95 |
| JE1021 | 5.25" 360KB (PC/XT/AT) Beige | \$89.95 |
| JE1022 | 5.25" 1.2MB (PC/XT/AT) Beige | \$99.95 |



JE1022 Pictured

IBM PC/XT/AT COMPATIBLE INTERNAL MODEMS

| | | |
|-------|--|----------|
| 1200H | 1200/300 Baud Internal Modem w/MaxiMite Comm. Software (PC/XT/AT) | \$69.95 |
| 2400H | 2400/1200/300 Baud Internal Modem w/MaxiMite Comm. Swr. (PC/XT/AT) | \$129.95 |

External Modems and Pocket-Size Modem Also Available!

PROTOTYPING PRODUCTS

Jameco Solderless Breadboards

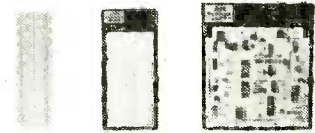

| Part No. | Dim. L" x W" | Contact Points | Binding Posts | Price |
|----------|--------------|----------------|---------------|---------|
| JE20 | 6.5x.75 | 200 | 0 | \$1.95 |
| JE21 | 3.25x2.125 | 400 | 0 | \$4.95 |
| JE22 | 6.5x1.325 | 630 | 0 | \$5.95 |
| JE23 | 6.5x2.125 | 830 | 0 | \$7.95 |
| JE24 | 6.5x3.125 | 1,360 | 2 | \$12.95 |
| JE25 | 6.5x4.25 | 1,660 | 3 | \$19.95 |
| JE26 | 6.875x5.75 | 2,390 | 4 | \$24.95 |
| JE27 | 7.25x7.5 | 3,220 | 4 | \$34.95 |

DATK Photo Etch PCB Kit Make your own circuit boards!

The ER4 photo etch kit contains all the chemicals necessary for any hobbyist, engineer or student to create professional circuit boards. Contains: Print frame, photo copy film, resist developer, etch resist, 2 copper circuit boards, concentrated etchant, film developer and fixer, resist patterns and complete instructions.



ER4 Photo Etch PCB Kit.....\$34.95

Jameco Prototype PC Boards

Specs: Laminated glass epoxy .062" thick 2 oz. copper clad with solder fin finish. All holes are .042" dia. on 10" x 10" grid pattern.

| | | |
|-------|--------------------------------------|---------|
| JE401 | 4.5"x6.5" 1-sided 3-hole pad pattern | \$9.95 |
| JE403 | 4.5"x6.5" 1-sided pwr & gnd busses | \$9.95 |
| JE405 | 4.5"x6.5" 1-sided general purpose | \$9.95 |
| JE407 | 5"x13.25" 2-sided general purpose | \$19.95 |
| JE417 | 4.2"x6.5" PC/XT 1/2 card proto board | \$19.95 |
| JE421 | 4.75"x3.7" IBM PC/XT Card Extender | \$19.95 |

JE401 Pictured

ENGINEERING/DATA BOOKS

| | | |
|--------|-------------------------------------|----------|
| 21035 | Sams TTL Cookbook (88) | \$14.95 |
| 21398 | Sams CMOS Cookbook (88) | \$19.95 |
| 22453 | Sams Op Amp Cookbook (88) | \$21.95 |
| 270645 | Intel 8-bit Controller Hndbk. (89) | \$19.95 |
| 270646 | Intel 16-bit Controller Hndbk. (89) | \$19.95 |
| 270647 | Intel 32-bit Controller Hndbk.(89) | \$19.95 |
| 400041 | NSC Linear Data Book Vol 1 (88) | \$14.95 |
| 400042 | NSC Linear Data Book Vol 2 (88) | \$9.95 |
| 400043 | NSC Linear Data Book Vol 3 (88) | \$9.95 |
| ICM89 | 1989 IC Master (3 Volume Set) | \$129.95 |

EDUCATIONAL KITS

| | | |
|-----------|---|---------|
| JE310/315 | Fiber optics kits demonstrate the principles of fiber optic system design. Complete step-by-step instructions, theory of operation and tutorial info. incl. | |
| JE2206 | Function generator kit provides three basic waveforms: sine, triangle and square wave. Frequency range: 1Hz to 100kHz | \$19.95 |
| JE310 | Fiber Optics Experimenter Kit..... | \$29.95 |
| JE315 | Advanced Fiber Optics Kit..... | \$29.95 |
| JE2206 | Function Generator Kit..... | \$19.95 |



JE2206 Pictured

1355 Shoreway Road
 Belmont, CA 94002
24 Hour Order Hotline (415) 592-8097
 FAX's (415) 592-2503 or (415) 595-2664
 Telex 176043 - Ans. Back: Jameco Blmt
 Data Sheets - 50c each
Send \$2.00 Postage for a FREE 1989 CATALOG
 © 1989 Jameco Electronics 5/89
 IBM is a registered trademark of International Business Machines



Mail Order Electronics • Worldwide
Jameco ELECTRONICS



\$20.00 Minimum Order - U.S. Funds Only
 CA Residents Add 6%, 6.5% or 7% Sales Tax
 Shipping - Add 5% plus \$1.50 Insurance
 (May vary according to weight)
 Terms: Prices subject to change without notice.
 We are not responsible for typographical errors.
 We reserve the right to substitute manufacturers.
 Items subject to availability and prior sale.
 Products pictured may only be representative.
 Complete list of terms/warranties is available upon request.

24-Hour Order Hotline (415) 592-8097 • The Following Phone Lines Are Available From 7AM - 5PM P.S.T.:
 • Customer Service (415) 592-8121 • Technical Assistance (415) 592-9990 • Credit Department (415) 592-9983 • All Other Inquiries (415) 592-7108

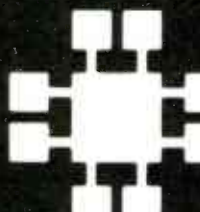

JDR Microdevices

MMC
MICROCOMPUTER
MARKETING COUNCIL
of the Direct Marketing Association, Inc.

• 30 DAY MONEY BACK GUARANTEE • 1 YEAR WARRANTY ON ALL PRODUCTS • TOLL-FREE TECHNICAL SUPPORT
• COMPLETE CUSTOMER SATISFACTION • SUPERIOR SERVICE • FRIENDLY, KNOWLEDGEABLE SALES STAFF

EPROMS

| PART | SIZE | SPEED | V _{DD} | PRICE |
|------------|----------|-------|-----------------|-------|
| 2708 | 1024x8 | 450ns | 25V | 4.95 |
| 2716 | 2048x8 | 450ns | 25V | 3.49 |
| 2716-1 | 2048x8 | 350ns | 25V | 3.95 |
| 2732 | 4096x8 | 450ns | 25V | 3.95 |
| 2732A | 4096x8 | 250ns | 21V | 3.95 |
| 27C64 | 8192x8 | 250ns | 12.5V | 4.95 |
| 2764 | 8192x8 | 450ns | 12.5V | 3.49 |
| 2764-250 | 8192x8 | 250ns | 12.5V | 3.69 |
| 2764-200 | 8192x8 | 200ns | 12.5V | 4.25 |
| 27128 | 16384x8 | 250ns | 12.5V | 4.95 |
| 27128A-200 | 16384x8 | 200ns | 12.5V | 5.95 |
| 27C256 | 32768x8 | 250ns | 12.5V | 5.95 |
| 27256 | 32768x8 | 250ns | 12.5V | 5.95 |
| 27256-200 | 32768x8 | 200ns | 12.5V | 7.95 |
| 27512 | 65536x8 | 250ns | 12.5V | 11.95 |
| 27C512 | 65536x8 | 250ns | 12.5V | 12.95 |
| 27C101-20 | 131072x8 | 200ns | 12.5V | 34.95 |

■ CALL TO CONFIRM CURRENT PRICES ■

STATIC RAMS

| PART | SIZE | SPEED | PRICE |
|--------------|---------|-------|-------|
| 2114 | 1024x4 | 450ns | .99 |
| 2114L-2 | 1024x4 | 200ns | 1.49 |
| TC5516 | 2048x8 | 250ns | 3.95 |
| TMM2016-200 | 2048x8 | 200ns | 3.25 |
| TMM2016-150 | 2048x8 | 150ns | 3.29 |
| TMM2016-100 | 2048x8 | 100ns | 4.29 |
| HM6116-4 | 2048x8 | 200ns | 4.95 |
| HM6116-3 | 2048x8 | 150ns | 5.95 |
| HM6116-2 | 2048x8 | 120ns | 6.45 |
| HM6116LP-4 | 2048x8 | 200ns | 5.95 |
| HM6116LP-3 | 2048x8 | 150ns | 6.45 |
| HM6116LP-2 | 2048x8 | 120ns | 6.95 |
| HM6264LP-15 | 8192x8 | 150ns | 9.95 |
| HM6264LP-12 | 8192x8 | 120ns | 10.95 |
| HM43256LP-15 | 32768x8 | 150ns | 17.95 |
| HM43256LP-12 | 32768x8 | 120ns | 19.95 |
| HM43256LP-10 | 32768x8 | 100ns | 24.95 |

■ CALL TO CONFIRM CURRENT PRICES ■

DYNAMIC RAMS

| PART | SIZE | SPEED | PRICE |
|-------------|-----------|-------|-------|
| 4116-200 | 16384x1 | 200ns | .89 |
| 4116-150 | 16384x1 | 150ns | .99 |
| 4164-150 | 65536x1 | 150ns | 2.89 |
| 4164-120 | 65536x1 | 120ns | 3.19 |
| 4164-100 | 65536x1 | 100ns | 3.95 |
| TMS4416 | 16384x4 | 150ns | 6.95 |
| 41128-150 | 131072x1 | 150ns | 5.95 |
| TMS4464-15 | 65536x4 | 150ns | 14.95 |
| TMS4464-12 | 65536x4 | 120ns | 15.95 |
| 41256-150 | 262144x1 | 150ns | 12.45 |
| 41256-100 | 262144x1 | 120ns | 12.95 |
| 41256-80 | 262144x1 | 80ns | 13.95 |
| MK4332 | 32768x1 | 200ns | 6.95 |
| HM51258-100 | 262144x1 | 100ns | 13.95 |
| 1 MB-120 | 1048576x1 | 120ns | 34.95 |
| 1 MB-100 | 1048576x1 | 100ns | 37.95 |

■ CALL TO CONFIRM CURRENT PRICES ■

CO-PROCESSORS

| | | |
|----------|--------|--------|
| 8087 | 5 MHz | 99.95 |
| 8087-2 | 8 MHz | 139.95 |
| 8087-1 | 10 MHz | 194.95 |
| 80287 | 6 MHz | 159.95 |
| 80287-8 | 8 MHz | 229.95 |
| 80287-10 | 10 MHz | 289.95 |
| 80387-16 | 16 MHz | 449.95 |
| 80387-SX | 15 MHz | 599.95 |
| 80387-20 | 20 MHz | 599.95 |
| 80387-25 | 25 MHz | 699.95 |



EPROM ERASERS

DATASE II \$39.95

■ SHIRT POCKET SIZE!
■ ERASES MOST EPROMS/
EPLDs IN 3 MINUTES ■ ALL
SIZES UP TO 4 AT A TIME
DATASE II



SPECTRONICS CORPORATION

| Model | Timer | # of Chips | Intensity (uW/cm ²) | Unit Cost |
|---------|-------|------------|---------------------------------|-----------|
| PE-140 | NO | 9 | 8,000 | \$ 89 |
| PE-140T | YES | 9 | 8,000 | \$139 |
| PE-240T | YES | 12 | 9,600 | \$189 |

HIGH-TECH SPOTLIGHT

HIGH SPEED CMOS

CMOS RUNS COOLER AND FASTER, AND USES LESS POWER!

| | | |
|---------|----------------------------------|---------|
| 80C86 | MICROPROCESSOR | \$13.95 |
| 80C88 | MICROPROCESSOR | \$12.95 |
| 82C51A | COMMUNICATIONS INTERFACE UART | \$3.95 |
| 82C53-5 | CMOS PROGRAMMABLE INTERVAL TIMER | \$3.95 |
| 82C54 | INTERVAL TIMER | \$6.95 |
| 82C55-5 | PERIPHERAL INTERFACE | \$3.95 |
| 82C59-5 | INTERRUPT CONTROLLER | \$4.95 |
| 82C82 | LATCH | \$5.95 |
| 82C83 | LATCH | \$5.95 |
| 82C84 | CLOCK GENERATOR | \$4.95 |
| 82C88 | BUS CONTROLLER | \$7.95 |

**PARTIAL LISTINGS ONLY!
CALL FOR COMPLETE CATALOG**

74 SERIES LOGIC

| 7400 | 74LS76 | 74S76 | 74S76 |
|-------|--------|-------|-------|
| 7400 | .19 | .29 | .29 |
| 7402 | .19 | .49 | .29 |
| 7404 | .19 | .49 | .29 |
| 7405 | .25 | .22 | .49 |
| 7406 | .29 | .39 | .35 |
| 7407 | .29 | .49 | .50 |
| 7408 | .24 | .36 | 1.69 |
| 7410 | .19 | .29 | 1.69 |
| 7411 | .25 | .49 | 1.69 |
| 7414 | .49 | .39 | .35 |
| 7416 | .25 | .39 | .79 |
| 7417 | .25 | .39 | 1.49 |
| 7420 | .19 | .39 | 1.49 |
| 7432 | .29 | .39 | 1.69 |
| 7447 | .89 | .39 | 1.69 |
| 7473 | .34 | 1.49 | |
| 7474 | .33 | .59 | .35 |
| 7475 | .45 | .49 | .35 |
| 7476 | .35 | .35 | .35 |
| 7586 | .18 | .29 | .35 |
| 7489 | 2.15 | .39 | .79 |
| 7490 | .39 | .39 | .39 |
| 7493 | .35 | .49 | .39 |
| 74121 | .29 | .65 | 1.29 |
| 74123 | .49 | .65 | |
| 74151 | .55 | .39 | |
| 74154 | 1.49 | .95 | |
| 74157 | .55 | .39 | |
| 74166 | 1.00 | .69 | |
| 74192 | .69 | .25 | |
| 74193 | .69 | .25 | |
| 74199 | .59 | .35 | |
| 74219 | .69 | .35 | |
| 74240 | .69 | .35 | |
| 74241 | .69 | .35 | |
| 74244 | .69 | .35 | |
| 74255 | .79 | 1.09 | |
| 74251 | .49 | .55 | |
| 74257 | .39 | .85 | |
| 74258 | .49 | .85 | |
| 74259 | 1.29 | .69 | |
| 74260 | .49 | .69 | |
| 74273 | .79 | .35 | |
| 74278 | .39 | .35 | |
| 74282 | 2.95 | | |
| 74297 | .23 | 2.49 | |
| 74330 | .17 | .39 | |
| 74332 | .18 | .39 | |
| 74338 | .26 | .79 | |
| 74342 | .39 | .79 | |
| 74347 | .75 | .79 | |
| 74351 | .17 | 1.49 | |
| 74373 | .29 | .89 | |
| 74374 | .24 | 3.20 | |
| 74375 | .29 | 2.40 | |

MICROPROCESSORS

| 6500 | | 8000 | | 8200 | |
|--------|--------|---------|-------|------------|-------|
| 6502A | 2.25 | 8031 | 3.95 | 8254 | 2.79 |
| 6502B | 2.69 | 8035 | 1.49 | 8255 | 1.99 |
| 6502B* | 4.25 | 8039 | 1.95 | 8255-5 | 2.49 |
| 65C02* | 7.95 | 8052AH | 8256 | 15.95 | |
| 6522 | 2.95 | BASIC | 34.95 | 8259 | 1.95 |
| 6526 | 13.95 | 8080 | 2.49 | 8259-5 | 2.29 |
| 6532 | 5.95 | 8085 | 1.95 | 8272 | 4.39 |
| 6551 | 2.95 | 8085A-2 | 3.75 | 8274 | 4.95 |
| 6581 | 14.95 | 8088 | 5.99 | 8275 | 16.95 |
| * CMOS | | 8088-2 | 7.95 | 8279 | 2.49 |
| | | 8155 | 2.49 | 8279-5 | 2.95 |
| | | 8155-2 | 3.95 | 8282 | 3.95 |
| | | 8156 | 2.95 | 8283 | 3.95 |
| 6800 | 1.95 | 6741 | 9.95 | 8284 | 2.25 |
| 6802 | 2.95 | 6748 | 7.95 | 8286 | 3.95 |
| 6803 | 3.95 | 6749 | 9.95 | 8287 | 3.95 |
| 6809 | 2.95 | 8755 | 14.95 | 8288 | 4.95 |
| 6809E | 2.95 | | | | |
| 6809E | 2.95 | | | | |
| 6809E | 5.49 | 8205 | 3.29 | Z80-CPU | 1.25 |
| 6808 | 2.49 | 8212 | 1.49 | Z80A-CPU | 1.29 |
| 6810 | 1.95 | 8216 | 1.49 | Z80B-CPU | 2.75 |
| 6811 | 1.25 | 8224 | 2.25 | Z80A-CTC | 1.69 |
| 68B21 | 1.85 | 8228 | 2.25 | Z80B-CTC | 4.25 |
| 6840 | 3.95 | 8237 | 3.95 | Z80A-DART | 5.95 |
| 6845 | 2.75 | 8237-5 | 4.75 | Z80B-DART | 6.95 |
| 6847 | 4.75 | 8238 | 4.49 | Z80A-DMA | 5.95 |
| 6850 | 1.95 | 8243 | 1.95 | Z80A-PIO | 1.89 |
| 68B50 | 1.75 | 8250 | 6.95 | Z80B-PIO | 4.25 |
| 6852 | 4.95 | 8251 | 1.29 | Z80A-SIO/0 | 5.95 |
| 6883 | 22.95 | 8251A | 1.69 | Z80A-SIO/1 | 5.95 |
| 68000 | 9.95 | 8253 | 1.59 | Z80A-SIO/2 | 5.95 |
| 68020 | 189.95 | 8253-5 | 1.95 | Z8671BASIC | 9.95 |

SIMM MODULES

| | | | | |
|-------------|--------------|---------|-------|----------|
| 41256A8B-15 | 256K x 8-BIT | FOR MAC | 150ns | \$89.00 |
| 41256A8B-12 | 256K x 8-BIT | FOR PC | 120ns | \$99.00 |
| 41256A8B-10 | 256K x 8-BIT | FOR MAC | 100ns | \$129.00 |
| 41256A9B-15 | 256K x 9-BIT | FOR PC | 150ns | \$119.00 |
| 41256A9B-12 | 256K x 9-BIT | FOR PC | 120ns | \$129.00 |
| 41256A9B-10 | 256K x 9-BIT | FOR PC | 100ns | \$139.00 |
| 41256A9B-80 | 256K x 9-BIT | FOR PC | 80ns | \$159.00 |
| 42100A9B-10 | 1MB x 9-BIT | FOR PC | 100ns | \$529.00 |
| 42100A9B-80 | 1MB x 9-BIT | FOR PC | 80ns | \$599.00 |

V-20 SERIES

SPEED UP YOUR PC BY 10% TO 40%

- HIGH SPEED ADDRESS CALCULATION IN HARDWARE ■ PIN COMPATIBLE WITH 8088
- LOW POWER CMOS
- SUPERSET OF 8088 INSTRUCTION SET

| | | |
|------|--------|-------|
| V20* | 5 MHz | 8.95 |
| V20* | 8 MHz | 10.95 |
| V20* | 10 MHz | 12.95 |
| V30 | 8 MHz | 13.95 |

PALS

| | | | |
|------|--------|------|--------|
| 16L8 | \$2.95 | 20R4 | \$4.95 |
| 16R8 | 2.95 | 20R6 | 4.95 |
| 16R6 | 2.95 | 20R8 | 4.95 |
| 16R4 | 2.95 | 20X8 | 4.95 |
| 20L8 | 4.95 | | |

STARTER KIT

EASY TO USE PAL PROGRAMMING KIT FOR ALL THE PAL DEVICES AT LEFT. MCT-PAL-SOFT \$99.95

LINEAR COMPONENTS

| | | | | | |
|--------|------|---------|------|----------|-------|
| TL071 | .69 | TL497 | 3.25 | MC3487 | 2.95 |
| TL072 | 1.09 | NE555 | .29 | LM3900 | .49 |
| TL084 | 1.49 | NE556 | .49 | LM3909 | .98 |
| LM301 | .34 | LM558 | .79 | LM3914 | 1.89 |
| LM309K | 1.25 | LM565 | .95 | IC7760 | 1.99 |
| LM311 | .59 | NE570 | 2.85 | 7805T | .49 |
| LM311K | 3.49 | NE570 | 2.85 | 7808T | .49 |
| LM317T | .69 | NE590 | .75 | 7812T | .49 |
| LM318 | 1.49 | LM723 | .49 | 7815T | .49 |
| LM319 | 1.25 | LM741 | .29 | 7905T | .59 |
| LM323K | 3.49 | MC1300 | 1.69 | 7912T | .59 |
| LM324 | .34 | MC1350 | 1.19 | 7915T | .59 |
| LM334 | 1.19 | LM1458 | .35 | MAX232 | 7.95 |
| LM336 | 1.75 | LM1488 | .49 | ICL8038 | 3.85 |
| LM338K | 4.49 | LM1489 | .49 | ICM7207A | .95 |
| LM339 | .59 | LM1496 | .85 | ICM7208 | 15.95 |
| LF353 | .59 | ULN2003 | .79 | 75150 | 1.95 |
| LF356 | .99 | XR2206 | 3.95 | 75154 | 1.95 |
| LM358 | .59 | XR2211 | 2.95 | 75188 | 1.25 |
| LM380 | .89 | CA3046 | .89 | 75189 | 1.25 |
| LM386 | .89 | CA3146 | 1.29 | 75451 | .39 |
| LM393 | .45 | MC3470 | 1.95 | 75452 | .39 |

MISC.

| | | | |
|----------|-------|------------|------|
| ADC0804 | 2.99 | 32.768 KHz | .95 |
| ADC0809 | 3.85 | 1.0 MHz | 2.95 |
| DAC0800 | 3.29 | 1.8432 | 2.95 |
| DAC0808 | 1.95 | 2.0 | 1.95 |
| 1793 | 9.95 | 2.4576 | 1.95 |
| 8272 | 4.39 | 3.279545 | 1.95 |
| CM8116 | 8.95 | 4.0 | 1.95 |
| UPD765 | 4.39 | 5.0688 | 1.95 |
| 1691 | 6.95 | 6.0 | 1.95 |
| 2143 | 6.95 | 8.0 | 1.95 |
| AYS-3600 | 10.0 | 10.0 | 1.95 |
| PRO | 11.95 | 12.0 | 1.95 |
| AY3-1015 | 4.95 | 14.31818 | 1.95 |
| AY5-1013 | 3.95 | 16.0 | 1.95 |
| | | | |

POWER SUPPLIES



135 WATT POWER SUPPLY
 ■ UL APPROVED
 ■ +5V @15A, +12V @ 4.2A,
 -5V @ 5A, -12V @ 5A
PS-135 \$59.95
PS-150 150W SUPPLY \$69.95

200 WATT POWER SUPPLY
 ■ UL APPROVED
 ■ +5V @ 20A, +12V @ 7A,
 -5V @ 5A, -12V @ 5A
PS-200 \$89.95

APPLE TYPE SUPPLY
 ■ WITH APPLE CONNECTOR
 ■ +5V @ 6A, +12V @ 3A,
 -5V @ 1A, -12V @ 1A
PS-A \$49.95

36 WATT POWER SUPPLY
 ■ +5V @2.5A, +12V @1.5A
 ■ 3 PIN INPUT, 6 PIN OUTPUT
 ■ SELECTABLE 110V-220V
PS-3045 \$12.95

SOLDER STATIONS



SOLDER/DESOLDER STATION
 ■ OIL-FREE VACUUM PUMP
 ■ TEMP ADJUSTS (212° F-900° F)
 & VACUUM (0-60 CM/HG)
 ■ WITH GUN-REST, COOLING TRAY,
 WIRE BRUSH & TIP CLEANER ROD
XY999SD \$399.95
XY999D DESOLDER ONLY \$349.99

DELUXE SOLDER STATION
 ■ ROTARY SWITCH TEMP
 CONTROL (200° F-878° F RANGE)
 ■ LED TEMPERATURE READOUTS
 ■ INCLUDES COOLING TRAY
XY9-60L \$79.95

SOLDER STATION
 ■ UL APPROVED
 ■ HEAT SETTING ADJUSTS
 ■ TIP TEMPERATURE READOUT
 ■ REPLACEMENT TIPS @ \$2.95
168-3C \$59.95

WIREWRAP PROTOTYPE CARDS

FR-4 EPOXY GLASS LAMINATE WITH GOLD PLATED
EDGECARD FINGERS AND SILK SCREENED LEGENDS



JDR-PR1 WITH +5V AND GROUND PLANE \$27.95
JDR-PR2 ABOVE WITH I/O DECODING LAYOUT \$29.95

FOR AT
JDR-PR10 16 BIT WITH I/O DECODING LAYOUT \$34.95
JDR-PR10PK PARTS KIT FOR JDR-PR10 ABOVE \$12.95

FOR PS/2
JDR-PR32 32 BIT PROTOTYPE CARD \$69.95
JDR-PR16 16 BIT WITH I/O DECODING LAYOUT \$49.95
JDR-PR16PK PARTS KIT FOR JDR-PR16 ABOVE \$15.95
JDR-PR16V 16 BIT FOR VIDEO APPLICATIONS \$39.95

JDR INSTRUMENTS—2 YEAR WARRANTY!

35 MHZ DUAL TRACE OSCILLOSCOPE
 ■ WIDE BAND WIDTH ■ VARIABLE HOLDOFF
MODEL-3500 (SHOWN) \$499.95

20 MHZ DUAL TRACE OSCILLOSCOPE
 ■ TV SYNC FILTER ■ COMPONENTS TESTER
MODEL 2000 \$389.95

3.5 DIGIT PROBE TYPE DMM
 ■ AUTORANGING ■ AC/DC 2V - 500V, RESIS. 2K-2M
DPM-1000 (SHOWN) \$54.95

3.5 DIGIT POCKET SIZE DMM
 ■ BASIC DC ACCURACY ±0.5% ■ 14 RANGES
DMM-100 \$29.95

3.5 DIGIT FULL FUNCTION DMM
 ■ BASIC DC ACCURACY ±0.25% ■ 22 RANGES
DMM-200 \$49.95

THE ULTIMATE 3.5 DIGIT DMM
 ■ BASIC DC ACCURACY ±0.25% ■ 34 RANGES
 ■ TEMP, TRANSISTOR & RESISTANCE FEATURES
DMM-300 (SHOWN) \$79.95



RELIABLE,
HIGH QUALITY
TEST EQUIPMENT,
REASONABLY
PRICED

DATA SWITCH BOXES

| TYPE | # OF POS. | PARALL. | SERIAL | PRICE |
|----------|-----------|---------|--------|-------|
| PUSHBTN. | 2-WAY | AB-P | AB-S | 39.95 |
| ROTARY | 2-WAY | RSP-2 | RSS-2 | 24.95 |
| ROTARY | 3-WAY | RSP-3 | RSS-3 | 27.95 |
| ROTARY | 4-WAY | RSP-4 | RSS-4 | 29.95 |

COMPUTER CABLES

GOLD-PLATED CONTACTS; 100% SHIELDED

CBL-PRINTER PC PRINTER CABLE 9.95
CBL-PRINTER-25 AS ABOVE-25 FT. 15.95
CBL-PRINTER-RA RT. ANGL. PRINTER 15.95
CBL-DB25-MM DB25 MALE-MALE 9.95
CBL-DB25-MF DB25 MALE-FEMALE 9.95
CBL-9-SERIAL 9 PIN-25 PIN SERIAL 6.95
CBL-KBD-EXT KEYBOARD EXTEN. 7.95
CBL-CNT-MM 36 PIN CENTRON-M/M 14.95
CBL-HD-20 20 PIN HARD DISK 3.95
CBL-HD-34D 34 PIN DUAL HARD DISK 6.95
CBL-FDC-EXT 37 PIN EXT. FLOPPY 9.95
CBL-MNT-9 9 PIN MONITOR EXTEN. 6.95
CBL-MODEM DB25-DB25 FEMALE 7.95

EXTENDER CARDS

FOR PROTOTYPE DEBUGGING,
TESTING AND TROUBLESHOOTING

EXT-8088 XT COMPATIBLE \$29.95
EXT-80286 AT COMPATIBLE \$39.95
EXT-16 MICROCHANNEL 16-BIT \$69.95
EXT-32 MICROCHANNEL 32-BIT \$99.95



NEW LOW
PRICES!
**SOLDERLESS
BREADBOARDS**

WBU-204-3 1360 TIE PTS \$12.95
WBU-204 1660 TIE PTS \$19.95
WBU-206 2390 TIE PTS \$24.95
WBU-208 3220 TIE PTS \$34.95

IDC CONNECTORS/RIBBON CABLE

| DESCRIPTION | ORDER BY | CONTACTS | | | | | | |
|-----------------------------|----------|----------|------|------|------|------|------|--|
| | | 10 | 20 | 26 | 34 | 40 | 50 | |
| SOLDER HEADER | IDHxxxS | .82 | 1.29 | 1.68 | 2.20 | 2.58 | 3.24 | |
| RIGHT ANGLE SOLDER HEADER | IDHxxxSR | .85 | 1.35 | 1.75 | 2.31 | 2.72 | 3.39 | |
| WIREWRAP HEADER | IDHxxxW | 1.86 | 2.98 | 3.84 | 4.50 | 5.28 | 6.63 | |
| RIGHT ANGLE WIREWRAP HEADER | IDHxxxWR | 2.05 | 3.28 | 4.22 | 4.45 | 4.80 | 7.30 | |
| RIBBON HEADER SOCKET | IDSxxx | .63 | .89 | .96 | 1.29 | 1.49 | 1.59 | |
| RIBBON HEADER | IDMxxx | — | 5.50 | 6.25 | 7.00 | 7.50 | 8.50 | |
| RIBBON EDGE CARD | IDExx | .85 | 1.25 | 1.35 | 1.75 | 2.05 | 2.45 | |
| 10' RIBBON CABLE | RCxx | 1.60 | 3.20 | 4.30 | 5.40 | 6.40 | 7.50 | |

FOR ORDERING INSTRUCTIONS, SEE D-SUBMINIATURE CONNECTORS BELOW

RS-232 BREAKOUT BOX

FOR TROUBLESHOOTING
SERIAL COMMUNICATIONS

■ OPEN/CLOSE INDIVIDUAL
CIRCUITS ■ 20 JUMPERS
CROSS-CONNECT ANY TWO
CIRCUITS ■ 10 CIRCUIT
ACTIVITY LEDS
GENDER-BO \$34.95



SURGE SUPPRESSOR

PROTECTS YOUR EQUIPMENT!

■ SIX 3-PRONG AC OUTLETS
 ■ 15 AMP CIRCUIT BREAKER
 ■ 6' HEAVY DUTY CORD
 ■ 15 AMP MAX. LOAD, 1875 WATTS
 ■ UL APPROVED
POWER-SURGE \$12.95
POWER-STRIP W/SURGE \$9.95



PC BREADBOARD

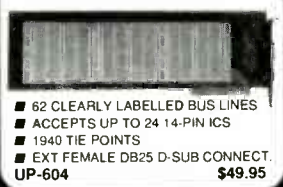

■ 62 CLEARLY LABELLED BUS LINES
 ■ ACCEPTS UP TO 24 14-PIN ICs
 ■ 1940 TIE POINTS
 ■ EXT FEMALE DB25 D-SUB CONNECT.
UP-604 \$49.95

D-SUBMINIATURE CONNECTORS

| DESCRIPTION | ORDER BY | CONTACTS | | | | | | |
|--------------------------|----------|----------|------|------|------|------|------|------|
| | | 9 | 15 | 19 | 25 | 37 | 50 | |
| SOLDER CUP | MALE | DBxxP | .45 | .59 | .69 | .69 | 1.35 | 1.85 |
| | FEMALE | DBxxS | .49 | .69 | .75 | .75 | 1.39 | 2.29 |
| RIGHT ANGLE PC SOLDER | MALE | DBxxPR | .49 | .69 | — | .79 | 2.27 | — |
| | FEMALE | DBxxSR | .55 | .75 | — | .85 | 2.49 | — |
| WIREWRAP | MALE | DBxxPWW | 1.69 | 2.56 | — | 3.89 | 5.60 | — |
| | FEMALE | DBxxSww | 2.76 | 4.27 | — | 6.84 | 9.95 | — |
| IDC RIBBON CABLE | MALE | IDHxxP | 1.39 | 1.99 | — | 2.25 | 4.25 | — |
| | FEMALE | IDBxxS | 1.45 | 2.05 | — | 2.35 | 4.49 | — |
| HOODS | METAL | MHOODxx | 1.05 | 1.15 | 1.25 | 1.25 | — | — |
| | PLASTIC | HOODxx | .39 | .39 | — | .38 | .69 | .75 |

ORDERING INSTRUCTIONS: INSERT THE NUMBER OF CONTACTS IN THE POSITION MARKED "xx" OF THE "ORDER BY" PART NUMBER LISTED. EXAMPLE: A 15 PIN RIGHT ANGLE MALE PC SOLDER WOULD BE DB15PR

MOUNTING HARDWARE .59

LITHIUM BATTERY

■ 6V FOR 286 AND 386 PCS
 ■ MOTHERBOARD CONNECTOR
 ■ ADHESIVE VELCRO MOUNTING
 STRIP
LITHIUM 6.8V \$11.95
COIN TYPE BATTERY
LONG-LASTING 3V LITHIUM
3V-MHW \$1.95
HOLDER \$1.49



GENDER CHANGERS

GENDER-FF FEMALE-FEMALE \$7.95
GENDER-MM MALE-MALE \$7.95
GENDER-MF MALE-FEMALE \$7.95
GENDER-NM NULL-MODEM \$8.95
GENDER-JB JUMPER BOX \$8.95
GENDER-MT MINITESTER \$14.95
GENDER-VGA DB9-DB15 \$19.95
GENDER-9-25 DB9-DB25 \$4.95



IC SOCKETS/DIP CONNECTORS

| DESCRIPTION | ORDER BY | CONTACTS | | | | | | | | | |
|---------------------|-----------|----------|------|------|------|------|------|------|------|------|--|
| | | 8 | 14 | 16 | 18 | 20 | 22 | 24 | 28 | 40 | |
| SOLDER TAIL SOCKETS | xxST | .11 | .11 | .12 | .15 | .18 | .15 | .20 | .22 | .30 | |
| WIREWRAP SOCKETS | WxWW | .59 | .69 | .69 | .99 | 1.09 | 1.39 | 1.49 | 1.69 | 1.99 | |
| ZIF SOCKETS | ZIFxx | — | 4.95 | 4.95 | — | 5.95 | — | 5.95 | 6.95 | 9.95 | |
| TOOLED SOCKETS | AUGATxxST | .62 | .79 | .86 | 1.09 | 1.29 | 1.39 | 1.49 | 1.69 | 2.49 | |
| TOOLED W/W SOCKETS | AUGATxxWW | 1.30 | 1.80 | 2.10 | 2.40 | 2.50 | 2.80 | 3.15 | 3.70 | 5.40 | |
| COMPONENT CARRIERS | ICCxx | .49 | .59 | .69 | .99 | .99 | .99 | .99 | 1.09 | 1.49 | |
| DIP PLUGS (IDC) | IDPxx | .95 | .49 | .59 | 1.29 | 1.49 | — | .85 | 1.49 | 1.59 | |

FOR ORDERING INSTRUCTIONS SEE D-SUBMINIATURE CONNECTORS ABOVE

APPLE-COMPATIBLE PRODUCTS

FLOPPY DRIVE FOR APPLE II SERIES
AP-150 (W/CABLE, CONNECTOR) \$99.95

REPLACEMENT KEYBOARD FOR APPLE II & II+
KEYBOARD-AP \$59.95

EPROM PROGRAMMER, NOT REC. FOR CMOS.
RP-525 (NO POWER SUPPLY REQ.) \$89.95

16K RAM CARD BOOSTS 48K APPLE TO 64K
RAM-CARD (2 YEAR WARRANTY) \$39.95

"SNAPABLE HEADERS"

SNAP APART TO MAKE ANY SIZE
HEADER, WITH .1" CENTERS

1 X 40 STRAIGHT LEAD .99
1 X 40 RIGHT ANGLE LEAD \$1.49
2 X 40 STRAIGHT LEAD \$2.49
2 X 40 RIGHT ANGLE LEAD \$2.99



JDR MICRODEVICES, 110 KNOWLES DRIVE, LOS GATOS, CA 95030
 LOCAL (408) 866-6200 FAX (408) 378-8927 TELEX 171-110
 RETAIL STORE: 1256 SOUTH BASCOM AVE., SAN JOSE, CA
 (408) 947-8881 HOURS: M-F 9-7 SAT. 9-5 SUN. 9-4

ORDER TOLL FREE 800-538-5000

COPYRIGHT 1989 JDR MICRODEVICES

CONTINENTAL U.S.

**2400 BAUD
MODEM
\$129.95**



- HAYES COMPATIBILITY ■ 1/2-CARD ■ AUTO DIAL/ANSWER
- SELF-TEST ON POWER UP ■ FULL AND HALF DUPLEX
- TOUCHTONE OR PULSE DIALING ■ 2ND PHONE JACK
- CALL PROGRESS MONITORING ■ ADJUSTABLE VOLUME

PRO-241

- INTERNAL MODEMS (MIRROR II SOFTWARE INCLUDED)**
- PRO-121 1200 BAUD 1/2 CARD \$69.95
 - PRO-24M 2400 BAUD FOR PS/2 \$249.95

- EXTERNAL MODEMS (REQ. SERIAL PT, CABLE, SOFTWARE)**
- PRO-24E 2400 BAUD \$169.95
 - PRO-12E 1200 BAUD \$99.95



**VGA
COMPATIBLE
PACKAGE
\$649**



- 800 X 560 MAX. RESOLUTION ■ 640 X 480 IN 16 COLORS
- 320 X 200 IN 256 COLORS ■ IBM STYLE MONITOR
- VGA, EGA, CGA, HERCULES, MONOCHROME COMPATIBLE
- VGA-PKG (INCLUDES ATI CARD AND MONITOR)

- NEC MULTISYNC II MONITOR \$599.95**
- AUTO FREQ ADJUSTMENT ■ RESOLUTION TO 800 X 560
 - IDEAL FOR CAD, CAM, WINDOWS ■ 9-15 PIN ADAPTER
- NEC-MULTI**

- JDR MULTI \$499.95**
- FULL FEATURED MULTISYNC MONITOR WITH UNLIMITED COLORS ■ HIGH RESOLUTION, 14" NON-GLARE DISPLAY
 - AUTO SWITCHING ■ TTL/ANALOG VIDEO INPUT
- JDR-MULTI**
- JDR-MONO (12" MONOCHROME MONITOR) \$69.95**

- EGA MONITOR \$399.95**
- 640 X 200/350 RESOLUTION ■ 31 MM DOT PITCH ■ 14" BLACK MATRIX SCREEN ■ 16 COLOR DISPLAY ■ 9-PIN CABLE
- EGA-MONITOR**

SAVE \$50! EGA CARD & MONITOR—JUST \$499

20 MB \$269 30 MB \$299

KITS INCLUDE A SEAGATE HARD DISK DRIVE, DRIVE CONTROLLER, CABLES AND INSTRUCTIONS.
HDKIT20 20 MB SYSTEM KIT
HDKIT30 30 MB SYSTEM KIT

FAST, RELIABLE SEAGATE HARD DISKS:

| DISK SIZE | MODEL | AVG. SPD. | SIZE | PRICE |
|-----------|----------|-----------|--------|-------|
| 20MB | ST-125 | 65 MS | 3-1/2" | \$259 |
| 20MB | ST-225 | 65 MS | 5-1/4" | \$225 |
| 30MB RLL | ST-238 | 65 MS | 5-1/4" | \$249 |
| 40MB | ST-251 | 40 MS | 5-1/4" | \$379 |
| 40MB | ST-251-1 | 28 MS | 5-1/4" | \$469 |
| 60MB RLL | ST-277 | 40 MS | 5-1/4" | \$449 |
| 80MB | ST-4096 | 28 MS | 5-1/4" | \$629 |

DFI HANDY SCANNER

400 DPI \$249.95

- INSTANTLY SCANS UP TO 4.1" WIDE IMAGES ■ 100, 200, 300, 400 DPI BOTH DIRECTIONS ■ 88W & 3 HALF-TONE MODES ■ 32 LEVELS OF GRAY SCALE ■ HERCULES, CGA, EGA AND VGA COMPATIBLE
 - INCLUDES HALO DPE AND IMAGE EDITOR SOFTWARE
- HS-3000**
OCR-SOFT SOFTWARE \$99.95



UPRIGHT CASE \$299.95

- SPACESAVING DESIGN HOLDS ALL SIZES OF MOTHERBOARDS. INCLUDES:
- 250W POWER SUPPLY ■ MOUNTS FOR 3 FLOPPY & 4 HARD DRIVES
 - TURBO & RESET SWITCH ■ LED SPEED DISPLAY ■ POWER & DISK LED'S
 - ALL HARDWARE, FACEPLATES & SPEAKER
- CASE-100**
- CASE-FLIP FOR 8088 BOARDS \$39.95
 - CASE-SLIDE FOR 8088 BOARDS \$39.95
 - CASE-70 FOR 286 BOARDS \$89.95
 - CASE-50 FOR 8088/286 BOARDS \$59.95
 - CASE-JR MINI-286 W/150W PS \$149.95



LOGITECH HIREZ MOUSE

\$89.95

- HIGH RESOLUTION BUS MOUSE. IDEAL FOR CAD WORK ■ 320 DPI ■ WITH DRIVER, TEXT EDITOR & POP-UP MENUS ■ NO PAD, POWER SUPPLY OR PORT REQ.
- LMOUSE-BH**



- LOGITECH 3 BUTTON MOUSE**
- PC MAGAZINE EDITORS CHOICE! ALL MODELS HAVE SERIAL SUPPORT (COM1/COM2), 200 D.P.I. RESOLUTION, LOTUS 1-2-3 SHELL, SELF-INSTALLING SOFTWARE AND "POINT EDITOR"
- LMOUSE \$74.95
 - LMOUSE-P SERIAL MOUSE W/LOGIPAINT \$89.95
 - LMOUSE-BP BUS MOUSE W/LOGIPAINT \$89.95
 - LMOUSE-BPBL BUS MOUSE W/PUBLISHER PKG \$129.95
 - LMOUSE-BPC BUS MOUSE W/LOGIPAINT/CAD \$139.95

KEYBOARDS

- 101 KEY ENHANCED, W/SEPARATE CURSOR PAD:**
- BTC-5339 AUTONSENSE FOR XT/AT, AUTOREPEAT \$79.95
 - K103-A AUDIBLE "CLICK" STYLE \$84.95
 - MAX-5339 MAXI-SWITCH W/TACTILE FEEDBACK \$84.95
- 84 KEY STYLES:**
- BTC-5060 AUTONSENSE FOR XT/AT \$59.95
 - MAX-5060 MAXI-SWITCH W/TACTILE FEEDBACK \$64.95

MODULAR CIRCUIT TECHNOLOGY NEW LOW PRICES!

- MOTHERBOARDS:**
- MCT-XMB STANDARD 8088 MOTHERBOARD \$87.95
 - MCT-TURBO 4.77/8 MHZ 8088 MOTHERBOARD \$95.95
 - MCT-TURBO-10 4.77/10 MHZ SINGLE CHIP 8088 \$99.95
 - MCT-M286 6/10 MHZ MINI-286 \$299.95
 - MCT-M286-12 6/12 MHZ MINI-286 \$339.95

- DRIVE CONTROLLERS:**
- MCT-FDC FLOPPY DISK CONTROLLER \$29.95
 - MCT-FDC-1.2 1.2 MB FLOPPY CONTROLLER \$69.95
 - MCT-HDC HARD DISK CONTROLLER \$79.95
 - MCT-RLL RLL CONTROLLER \$119.95
 - MCT-FH FLOPPY/HARD CONTROLLER \$139.95
 - MCT-AFH 286/386 FLOPPY/HARD \$149.95
 - MCT-AFH-RLL 286/386 RLL CONTROLLER \$199.95

- DISPLAY ADAPTOR CARDS:**
- MCT-MGP MONOCHROME GRAPHICS \$59.95
 - MCT-CG COLOR GRAPHICS ADAPTOR \$49.95
 - MCT-EGA ENHANCED GRAPHICS ADAPTOR \$149.95
 - MCT-MGMIO MONOGRAPHICS MULTI I/O \$119.75
 - MCT-MGAIO 286/386 MONOGRAPHICS I/O \$99.95

- MULTIFUNCTION CARDS:**
- MCT-MIO MULTI I/O FLOPPY CONTROLLER \$79.95
 - MCT-I/O MULTI I/O CARD \$59.95
 - MCT-AMF 286/386 MULTIFUNCTION \$139.95
 - MCT-AIO 286/386 MULTI I/O CARD \$59.95

- MEMORY CARDS:**
- MCT-RAM 576K RAM CARD \$59.95
 - MCT-EMS EXPANDED MEMORY CARD \$129.95
 - MCT-AEMS 286/386 EMS CARD \$139.95

1 Mb 3 1/2" DRIVE \$99.95

- ULTRA HIGH DENSITY
- READ/WRITE 720K DISKS, T...
- FDD-1.44X BLACK FACEPLATE
- FDD-1.44A BEIGE FACEPLATE
- FDD-1.44 SOFT SOFTWARE DRIVER \$19.95



1/2 HEIGHT FLOPPY DISK DRIVES:

- FD-55B 5-1/4" TEAC DS/DD 360K \$99.95
- FD-55G 5-1/4" TEAC DS/HD 1.2M \$129.95
- FDD-360 5-1/4" DS/DD 360K \$69.95
- FDD-1.2 5-1/4" DS/HD 1.2M \$109.95
- FDD-3.5X 3-1/2" 720K (BLACK) \$97.95
- FDD-3.5A 3-1/2" 720K (BEIGE) \$97.95

NASHUA DISKETTES (BOXES OF 10):

- N-MD2D 360K DS/DD \$6.95
- N-MD2D BULK (MULTIPLIES OF 50 DISKS) EACH \$4.95
- N-MD2H 1.2 MB DS/HD \$13.95
- N-3.5HD 1.44 MB 3-1/2" DS/HD \$49.95
- N-3.5DS 720K 3-1/2" DD/DS \$16.95

BUILD YOUR OWN SYSTEM!

OVER 25,000 JDR SYSTEMS HAVE BEEN BUILT. OUR DETAILED INSTRUCTIONS MAKE IT VERY EASY—ALL YOU NEED IS ABOUT 2 HOURS AND A SCREWDRIVER!



VIDEO INSTRUCTIONS \$4.95 WITH SYSTEM

OUR 20 MINUTE VIDEO SHOWS YOU STEP-BY-STEP HOW TO BUILD AN XT-COMPATIBLE SYSTEM. SPECIFY VHS OR BETA. VIDEO WITH SYSTEM KIT, \$4.95 VIDEO ALONE, 19.95

10 MHZ TURBO 8088 SYSTEM \$636.20

- SERIAL /PARALLEL PORTS, CLOCK/CALENDAR & GAME ADAPTOR
- RUNS COLOR GRAPHICS SOFTWARE ON ITS MONOCHROME MONITOR ■ MOTHERBOARD ■ 256K RAM MEMORY ■ 135W POWER SUPPLY ■ FLIPTOP CASE
- 84 KEY KEYBOARD ■ 360K FLOPPY DRIVE
- MONOGRAPHICS I/O CARD

12 MHZ MINI-286 SYSTEM \$1152.70

- 12 MHZ MINI-286 MOTHERBOARD ■ 512K RAM MEMORY
- MINI-AT CASE W/POWER SUPPLY ■ 84 KEY KEYBOARD
- MONOCHROME MONITOR ■ 1.2 MB FLOPPY DRIVE
- FLOPPY/HARD CONTROL ■ MONOGRAPHICS CARD

EPROM PROGRAMMER \$1299.95

- PROGRAMS 27XX AND 27XXX EPROMS UP TO 27512
 - SUPPORTS VARIOUS PROGRAMMING FORMATS & VOLTAGES ■ SPLIT OR COMBINE CONTENTS OF SEVERAL EPROMS OF DIFFERENT SIZES
 - READ, WRITE, COPY, ERASE, CHECK & VERIFY
 - SOFTWARE FOR HEX AND INTEL HEX FORMATS
- MOD-EPROM**



MODULAR PROGRAMMING SYSTEM

INTEGRATED MODULAR SYSTEM EASILY EXPANDS! ALL MODULES USE A COMMON HOST ADAPTOR CARD-- USE JUST ONE SLOT TO PROGRAM EPROMS, PROMS, PALS & MORE

HOST ADAPTOR CARD \$29.95

- UNIVERSAL INTERFACE FOR ALL THE PROGRAMMING MODULES!
 - SELECTABLE ADDRESSES PREVENTS CONFLICTS
 - MOLDED CABLE
- MOD-MAC**

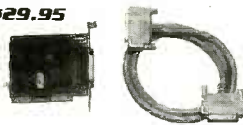

UNIVERSAL MODULE \$499.95

- PROGRAMS EPROMS, EEPROMS, PALS, BI-POLAR PROMS, 8748 & 8751 SERIES DEVICES, 16V8 AND 20V8 GALS (GENERIC ARRAY LOGIC) FROM LATTICE, NS, SGS ■ TESTS TTL, CMOS, DYNAMIC & STATIC RAMS ■ LOAD DISK, SAVE DISK, EDIT, BLANK CHECK, PROGRAM, AUTO, READ MASTER, VERIFY AND COMPARE
 - TEXT TOOL SOCKET FOR .3" TO .6" IC'S (8-40 PINS)
- MOD-MUP**

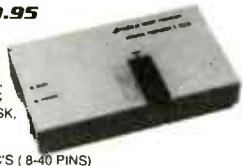

EPROM MODULE \$119.95

- PROGRAMS 24-32 PIN EPROMS, CMOS EPROMS & EEPROMS FROM 16K TO 1024K ■ HEX TO OBJ CONVERTER ■ AUTO, BLANK CHECK/PROGRAM/VERIFY ■ VPP 5, 12.5, 12.75, 13, 21 & 25 VOLTS
- NORMAL, INTELLIGENT, INTERACTIVE, & QUICK PULSE PROGRAMMING ALGORITHMS

- MOD-MEP
- MOD-MEP-4 4-EPROM PROGRAMMER \$169.95
- MOD-MEP-8 8-EPROM PROGRAMMER \$259.95
- MOD-MEP-16 16-EPROM PROGRAMMER \$499.95

DIGITAL IC MODULE \$129.95

- TESTS TTL, CMOS, DYNAMIC, & STATIC RAM
 - AUTO SEARCH FOR UNKNOWN PART NUMBERS
 - USER-PROGRAMMABLE TEST PROCEDURES
- MOD-MIC**

PAL MODULE \$249.95

- PROGRAMS MMI, NS, TI 20 & TI 24 PIN DEVICES
- BLANK CHECK, PROGRAM, AUTO, READMASTER, VERIFY & SECURITY FUSE BLOW

- MOD-MPL
- PAL PROGRAMMING DEVELOPMENT SOFTWARE
- MOD-MPL-SOFT \$99.95

JDR MICRODEVICES, 110 KNOWLES DRIVE, LOS GATOS, CA 95030
 LOCAL (408) 866-6200 FAX (408) 378-8927 TELEX 171-110
 RETAIL STORE: 1256 S. BASCOM AVE., SAN JOSE, CA
 (408) 947-8881 HOURS: M-F, 9-7 SAT. 9-5 SUN. 12-4

Terms: Minimum order \$10.00. For shipping & handling include \$3.50 for ground and \$4.50 air. Orders over 1 lb and foreign orders may require additional shipping charges—please contact the sales department for the amount. CA residents must include applicable sales tax. Prices subject to change without notice. We are not responsible for typographical errors. We reserve the right to limit quantities and to substitute manufacturer. All merchandise subject to prior sales. A full copy of our terms is available upon request. Items pictured may only be representative.

ORDER TOLL FREE 800-538-5000

COPYRIGHT 1989 JDR MICRODEVICES.

CONTINENTAL US

CIRCLE 171 ON FREE INFORMATION CARD

www.americanradiohistory.com

RADIO-ELECTRONICS

Radio Shack Parts Place™

SUPER SELECTION, SUPER VALUES—COME IN TODAY!

"Hotline" Special-Order Service

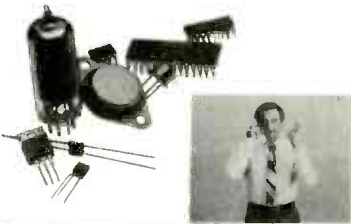

Save Postage! We Deliver to Your Local Radio Shack
Save Time! Delivery on Most Items in One Week

Your Radio Shack store manager can special-order a wide variety of parts and accessories not shown in our catalog—tubes, ICs, phono cartridges and styli, crystals, SAMS Photofacts®. No minimum or handling charge!

Get Your Novice Ham License

1995

Complete Self-Study Course



Prepared by Gordon West, WB6NOA

Take advantage of the new voice and radio-computing privileges! Includes two self-paced code cassettes, study guide with exam questions and answers, FCC Form 610 and a sturdy molded binder. #62-2402

Computer Hookups



| Fig. | Description | Cat. No. | Price |
|------|-------------------------------|----------|-------|
| 1 | 6-Ft. Grounded AC Power Cord | 278-1257 | 3.99 |
| 2 | "Snap" Toroid Choke Cores (2) | 273-104 | 6.95 |
| 3 | IDC Installation Tool | 276-1596 | 12.95 |
| 4 | Male D-Sub 25 Connector | 276-1559 | 3.99 |
| — | Female D-Sub 25 | 276-1565 | 3.99 |
| — | 36-Position IDC Male | 276-1533 | 4.99 |
| — | 36 Position IDC Female | 276-1523 | 4.99 |

ICs for Experimenters



VCP200 Voice Recognizer. Easy-to-use LSI device understands seven preset motion and start/stop commands. With data. #276-1308 . . . 9.95

TDA7000 FM Receiver. RF, mixer, 70 kHz IF and demod stages in one IC. With data. See project in July '88 *Hands On Electronics*. #276-1304 . . . 5.95

Solar Project Kit



995

Harness The Sun!



Great for scouts or school science class! Includes mini solar panel, motor, color wheel, propeller, project booklet. #277-1201

Capacitor Bargains

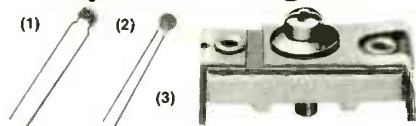

- (1) **0.1 µF Monolithics.** 50 WVDC. High capacity in a tiny size—ideal for on-board noise cleanup. #272-109 . . . Pkg. of 5/1.79
- (2) **Low-pF Assortment.** 50 ceramic discs, hard-to-find values from 1 to 33 pF. 50 WVDC. #272-806 . . . Pkg. of 50/2.99
- (3) **95-420 pF Trimmer.** #272-1336 . . . 1.69

Antenna Components

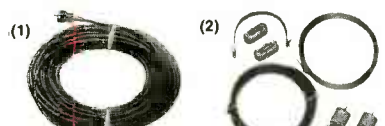

- (1) **50 Feet of RG-58 52-Ohm Cable.** Top quality and prewired! PL-259 plug at each end. #278-971 . . . 11.95
- (2) **Shortwave Antenna Kit.** 75 feet of copper antenna wire, 50 feet of lead-in, window feed-through and insulators. #278-758 . . . 8.49

Project Accessories



- (1) **9V Battery Holders.** #270-326 . . . 2/69¢
- (2) **Case.** For a controller, beeper, small portable device. 3¼ x 2½ x 1". Removable end panel. #270-293 . . . 3.99
- (3) **SPDT Lever Switch.** #275-016 . . . 1.69

Resistor Values

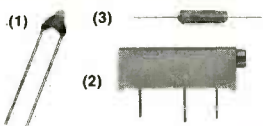

- (1) **Precision Thermistor.** Range: -50 to +110° C. #271-110 . . . 1.99
- (2) **15-Turn Trimmer Pots.** Select from 1k, #271-342. 10k, #271-343. 20k, #271-340 . . . Each 1.49
- (3) **8-Ohm Non-Inductive Resistor.** 20W. #271-120 . . . 1.39

Bench Helpers

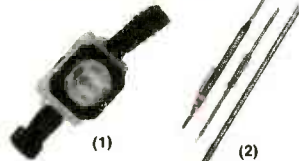

- (1) **Head Light.** Really handy—puts light where you look! Comfortable band. #61-2510 . . . 3.99
- (2) **Anti-Static TV/RF Alignment Tool Set.** #64-2230 . . . 3.99

Chime and Buzzers



- (1) **Electronic Chime.** Delivers pleasant "ding-dong" output. #273-071 . . . 8.69
- (2) **Two-Tone Piezo Alert.** For 6 to 18VDC. Extra-loud. #273-070 . . . 9.95
- (3) **Miniature DC Buzzers**

| DC Voltage | Cat. No. | Each |
|------------|----------|------|
| 1.5 to 3 | 273-053 | 1.99 |
| 6 | 273-054 | 1.99 |
| 12 | 273-055 | 1.99 |

Optoelectronics

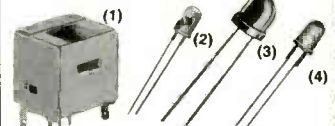

- (1) **Infrared Detector Module.** Built-in amp. 5VDC. #276-137 . . . 3.49
- (2) **SEP8703-1 Infrared LED.** Low power and high output. #276-143 . . . 1.69
- (3) **Blinking Red LED.** Super indicator! #276-036 . . . 1.29
- (4) **Blinking Green LED.** 1 Hz flash rate. #276-030 . . . 1.29

Handy Tools



- (1) **Adjustable Project Holder.** For easier soldering, gluing and assembly. #64-2093 . . . 7.99
- (2) **Dual-Wattage Soldering Iron.** Go from 15 to 30 watts with the flick of a switch. Replaceable tip. 8¼" long. #64-2055 . . . 8.95

Logic Probe and Pulsar



- Probe.** LEDs and tones reveal logic states in digital circuits. #22-303 . . . 16.95
- Pulsar.** Teammate for the probe. Produces a single 5 µs pulse or a continuous pulse train at the push of a button. #22-304 . . . 17.95

Clamp-On AC Meter



Measures AC current without direct connection to circuit and AC voltage with included test leads. Plug-in inductive pickup/multiplier for testing devices with an AC cord. #22-161

Over 1000 items in stock! Binding Posts, Books, Breadboards, Buzzers, Capacitors, Chokes, Clips, Coax, Connectors, Fuses, Hardware, ICs, Jacks, Knobs, Lamps, Multitesters, PC Boards, Plugs, Rectifiers, Resistors, Switches, Tools, Transformers, Transistors, Wire, Zeners, More!

Prices apply at participating Radio Shack stores and dealers

Radio Shack®
The Technology Store™

A DIVISION OF TANDY CORPORATION

CIRCLE 78 ON FREE INFORMATION CARD

★ **QUALITY PARTS** ★ **DISCOUNT PRICES** ★ **FAST SHIPPING**

ALL ELECTRONICS CORP.

3 to 6 Vdc MOTOR with GEARBOX

Probably designed for child's toy. Lever selects 2 forward and one reverse speed. 1st gear approx. 120 rpm/6vdc, 2nd gear approx. 90 rpm/6vdc, Reverse approx. 120 rpm/6vdc.

3.35" X 1.75" X 3.25"
CAT# DCM-10 \$6.00

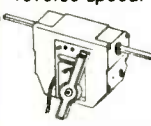

CASSETTE MECHANISM

Alpine cassette transport mechanism. Includes stereo tape head, Mitsubishi # MET-3RF2B 13.2 Vdc motor, belt, pulleys, capstan, fast-forward, rewind and eject actuator. Does not include amplifier section. 6 1/2" X 5 1/4" X 1 3/4".

CAT# CMEC-5 \$7.50 each
 10 for \$65.00

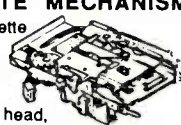

6 VOLT D.C. 9.5 AMP/HOUR GEL-CELL

Elpower# 695
 6 volt, 9.5 amp/hour rechargeable gel-cell battery. 4.25" X 2.75" X 5.5". Quick connect terminals.

CAT# GC-695 \$15.00 each



0 - 8 AMP DC METER

No shunt required. 2 2/8" square. Black plastic and white face clearly marked "DC Amperes". Ideal for power supplies, battery chargers, etc.

CAT# MET-12 \$3.75 each



WALL TRANSFORMERS

ALL PLUG DIRECTLY INTO 120 VAC OUTLET

6 Vdc @ 200 ma. **CAT# DCTX-620 \$2.25**
 6 Vdc @ 750 ma. **CAT# DCTX-675 \$3.50**
 9 Vdc @ 250 ma. **CAT# DCTX-925 \$2.50**
 12 Vdc @ 930 ma. **CAT# ACTX-1293 \$3.50**
 18 Vdc @ 1 amp. **CAT# ACTX-1885 \$3.50**



LED'S

STANDARD JUNBO
 DIFFUSED T 1-3/4 size

RED CAT# LED-1 10 for \$1.50 - 100 for \$13.00
GREEN CAT# LED-2 10 for \$2.00 - 100 for \$17.00
YELLOW CAT# LED-3 10 for \$2.00 - 100 for \$17.00

FLASHING LED
 operates on 5 volts...
RED \$1.00 each
CAT# LED-4 10 for \$9.50
GREEN \$1.00 each
CAT# LED-4G 10 for \$9.50

BI-POLAR LED
 Lights RED one direction, GREEN the other. Two leads.
CAT# LED-6 2 for \$1.70

LED HOLDER
 Two piece holder.
CAT# HLED 10 for 85¢



MINIATURE BCD THUMBWHEEL SWITCHES

SMK# J-D0001 #01
 Each switch has digits 0-9. Snap together to make up any necessary configuration. Designed to mount directly to P.C. board. Pins on .1" centers. Each switch is .64" high X .59" wide X .235" thick.

CAT# SWTH-5 2 for \$1.00
 10 for \$4.50 - 100 for \$40.00



PIEZO WARNING DEVICE

Muratec Ene # PK88-4A0
 High pitched audible alarm. Operates on 3 - 20 Vdc @ 20 ma. 1" high x 7/8" dia. P.C. board mount.

CAT# PBZ-84 \$1.75 each



WIDE BAND AMPLIFIER

NECA UPC1651G. 1200 Mhz @ 3 db. Gain: 19db @ 1-500 hz. 5 volt operation. Small package 4mm dia. X 2.5 mm thick.

CAT# UPC-1651 2 for \$1.00
 10 for \$4.50 - 100 for \$35.00

N-CHANNEL MOSFET
 IRF-511 TO-220 case
CAT# IRF 511
 \$1.00 each - 10 for \$9.00
 LARGE QUANTITY AVAILABLE



SWITCHES

ITT PUSH BUTTON
 ITT MDPL series. 3/4" X 1/2" gray rectangular key cap. S.P.S.T. N.O.

Push to close. RATED. 0.1 amp switching, 0.25 amp carry current. P.C. mount. **CAT# PB-8** 65¢ each - 10 for \$6.00 - 100 for \$50.00



RELAYS

12 VOLT D.C. COIL S.P.D.T.
 Omron G2E-184P. 4 Amp contacts 335 ohm coil. Sugar cube size. .81" X .42" X .44" high. P.C. mount with pins on DIP spacing.

CAT# RLY-787 \$1.50 each

5 VOLT DC SIP RELAY
 Gould, Allied Controls SR-1A-5VDC
 SPST-normally open SIP relay. 95 ohm coil. 2 amp contacts. 1/2" X 20" X 39" high. Housing resists flammable and chlorinated commercial solvents.

CAT# RLY-SIP8 \$1.00 each - 10 for \$8.50



SOUND AND VIDEO MODULATOR

Tie UM1381-1. Designed for use with T.I. computers. Can be used with video cameras, games or other audio/video source. Built in A/B switch enables user to switch from T.V. antenna without disconnection. Operates on channel 3 or 4. Requires 12 Vdc. Hook up diagram included.

CAT# AVMOD \$5.00 each



NICKEL-CAD BATTERIES (RECHARGEABLE)

SPECIAL// AAA SIZE
 Panasonic P-18AAA 1.2 volt @ 180 MAH
CAT# NCB-AAA \$1.50 each
 10 for \$13.50 - 100 for \$125.00

AA SIZE \$2.00 each
 1.25 volts 500 mA.
CAT# NCB-AA

AA SIZE \$2.20 each
 WITH SOLDER TABS
CAT# NCB-SAA

C SIZE \$4.25 EACH
 1.2 volts 1200 mA
CAT# NCB-C

D SIZE \$4.50 each
 1.2 volts 1200 mA
CAT# NCB-D



STROBE KIT

Variable rate strobe kit, flashes between 60 to 120 times per minute. Will operate on either 6 or 12 Vdc depending upon how you wire the circuit. Comes complete with P.C. board and instructions for easy assembly.

CAT# STROBE-1 \$7.50 each



10 POSITION MINI-ROTARY

Grayhill 56P36-01-1-10N-C
 Mini rotary switch. Non-shorting. 1 deck, 10 positions. .125" dia. shaft X .375" long. .377" behind the panel depth. P.C. pins.

CAT# MRS-10 WAS \$2.50 NOW \$1.50 each

SPDT PUSHBUTTON
 Marquardt 1843
 Rated 8 amps @ 125/250 Vac
 Black plastic pushbutton. Switch body: .92" X .94" X .65".

CAT# PB-18 \$1.65 each - 10 for \$15.00 each



10 AMP SOLID STATE RELAY

ELECTROLA S2181
 CONTROL:
 Rated 5.5 to 10 Vdc (will operate on 3-32 Vdc).
 LOAD: 10 amp @ 240 Vac
 2 1/4" X 1 3/4" X 7/8"

CAT# SSRLY-10B \$9.50 each
 QUANTITY DISCOUNT
 10 for \$85.00 - 25 for \$175.00
 50 for \$300.00 - 100 for \$500.00



LIGHT ACTIVATED MOTION SENSOR

This device contains a photo cell which senses sudden change in ambient light. Could be used as a door annunciator or modified to trigger other devices. 5 1/2" X 4" X 1". Operates on 6 Vdc. Requires 4 AA batteries (not included).

CAT# LSMD \$5.75 per unit

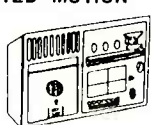

TRANSISTORS

ORDER BY PART #

PN2222 NPN
 TO-92 5 for 75¢
PN2907 PNP
 TO-92 5 for 75¢
2N 3055 NPN
 TO-3 \$1.00 each
MJ2955 PNP
 TO-3 \$1.50 each
MJE2955 PNP
 TO-220 75¢ each
MJE3055 NPN
 TO-220 75¢ each
TIP31 NPN
 TO-220 75¢ each
TIP32 PNP
 TO-220 75¢ each
TIP121 NPN
 TO-220 75¢ each
TIP126 PNP
 TO-220 75¢ each



TELEPHONE COUPLING TRANSFORMER

Multi Products International A19N HO-1D/1
 Primary 600 ohm
 Secondary: 600/600 ohm
 77" X 61" X .83" high.
 6 p.c. pins on .187" centers.
 Primary inductance:
 300 mH min. at 1kHz, 1 volt.

CAT# TCTX-1 \$1.25 each
 10 for \$11.00 - 100 for \$95.00



LOOK WHAT \$1.00 WILL BUY

200 ASSORTED 1/4 WATT RESISTORS
 Bent leads, carbon comp. and carbon film.
CAT# GRES \$1.00 per assortment

200 ASSORTED 1/2 WATT RESISTORS
 Bent leads, carbon comp and carbon film.
CAT# GRABE \$1.00 per assortment

50 ASSORTED DISC CAPACITORS
 Most are out (p.c. leads). Some to 500 volts
CAT# GRABC \$1.00 per assortment

15 VALUES OF ELECTROLYTICS
 Contains both axial and radial styles from 1 mfd.
CAT# GRABC \$1.00 per assortment

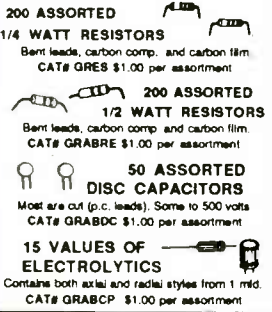

XENON TUBE

1" long flashtube prepped with 3 1/2" red and black leads. Ideal for electronic flash or strobe projects.

CAT# FLT-3 2 for \$1.00

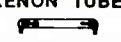

1/4 WATT RESISTOR KIT

Ideal for the workshop, this 1/4 watt resistor kit contains 10 pieces each of 42 of the most popular values (420 pieces total). Includes a divided box and a parts locator.

VALUES in this kit are:
 1 ohm, 10 ohm, 39 ohm, 47 ohm, 51 ohm, 68 ohm, 100 ohm, 130 ohm, 150 ohm, 180 ohm, 220 ohm, 330 ohm, 470 ohm, 500 ohm, 680 ohm, 1K, 1.2K, 1.5K, 2K, 2.2K, 2.7K, 3K, 4.7K, 5.1K, 5.6K, 10K, 15K, 22K, 30K, 33K, 39K, 47K, 56K, 68K, 100K, 120K, 150K, 220K, 470K, 1 MEG, 5.1 MEG, 10 MEG

The resistors alone would sell for \$21.00.
Complete kit - CAT# REKIT-14 \$17.00



OPTO SENSOR

U shaped package with mounting ears. 1/8" opening. 3/4" mounting holes. **CAT# OSU-8 50¢ each**
 10 for \$4.50 - 100 for \$40.00



MOTORS

1 1/2 Vdc TOY MOTOR
 Best Motor Co. # R-20
 Designed to run on 1.5 volt batteries. 0.83" diameter, 1.14" long, 0.08" dia. shaft is 0.32" long. Prepped with red and blue wire leads. Ideal for toys, science projects and low power applications.

CAT# DCM-15 3 for \$1.00
 10 for \$3.00 - 100 for \$25.00

3-6 Vdc MOTOR
 Mabuchi Motor.
 1.06" diameter X 1.42" long. .09" diameter knurled shaft X .2" long. Solder terminals. Threaded mounting holes on .65" centers.

CAT# DCM-18 65¢ each
 10 for \$6.00 - 125 for \$62.50



CALL OR WRITE FOR OUR FREE CATALOG OVER 4000 PARTS!



56 pages!

MAIL ORDERS TO:
ALL ELECTRONICS
 P.O. BOX 567
 VAN NUYS, CA 91408

TWX-5101010163 (ALL ELECTRONIC)

OUTSIDE THE U.S.A. SEND \$2.00 POSTAGE FOR A CATALOG!!

ORDER TOLL FREE
800-826-5432

INFO: (818)904-0524
 FAX: (818)781-2653

MINIMUM ORDER \$10.00
 QUANTITIES LIMITED
 CALIF. ADD SALES TAX
 USA: \$3.00 SHIPPING
 FOREIGN ORDERS
 INCLUDE SUFFICIENT SHIPPING. NO C.O.D.





ADVERTISING INDEX

RADIO-ELECTRONICS does not assume any responsibility for errors that may appear in the index below.

| Free Information Number | Page | | | | | | | |
|-------------------------|----------------------------|--------|-----|------------------------------|-------------|----------|------------------------------|--------|
| 108 | AMC Sales | 53 | 127 | Deco Industries | 69 | 189 | Opto Electronics | 25 |
| 183 | Ace Communications | 58 | 82 | Digi-Key | 94 | — | Pacific Cable | 89, 92 |
| 75 | Ace Products | 69 | 178 | Electronic Goldmine | 90 | 56 | Parts Express | 93 |
| 52 | Active Electronics | 104 | 184 | Electronics Book Club | 33 | 185 | Prime Electronics | 90 |
| 107 | All Electronics | 102 | 121 | Fluke Manufacturing | CV2 | 187 | Print Products International | 73 |
| — | Amazing Concepts | 88, 91 | — | Grantham College of Eng. | 16 | 78 | Radio Shack | 101 |
| 106 | American Design Components | 103 | 86 | Heathkit | 95 | — | Scope Electronics | CV4 |
| 84 | Appliance Service | 69 | 65 | IS CET | 75 | 176, 177 | Sencore | 15, 71 |
| 76 | Associated Electronics/3M | 24 | 65 | J & W | 13 | 51 | Silicon Valley Surplus | 92 |
| 67 | Banner Technical Books | 75 | 113 | JDR Microdevices | 100, 98, 99 | — | Soar | 27 |
| 98 | Beckman Industrial | 3 | 114 | Jameco | 96, 97 | — | Star Circuits | 73 |
| 109 | C & S Sales | 7 | 115 | Jensen Tools | 69 | 83 | Synergetics | 62 |
| 70 | CEI | 93 | — | Joseph Electronics | 23 | 73 | T S M | CV3 |
| 188 | CG Soar | 27 | 87 | MCM Electronics | 91 | 92 | Tektronix | 5 |
| 60 | CIE | 34, 31 | 53 | MD Electronics | 88 | 181 | Tentel | 28 |
| 50 | Caig Laboratories | 28 | 93 | Mark V. Electronics | 69, 92 | 123 | Test Probes | 26 |
| 54 | Chemtronics | 58 | — | McGraw Hill Book Club | 18 | 182 | Time Motion Tools | 69 |
| — | Command Productions | 53 | — | McGraw Hill Cont. Ed. Series | 65 | 180 | WPT Publications | 32 |
| 179 | Communications Specialists | 32 | 61 | Microprocessors Unltd. | 84 | | | |
| 58 | Cook's Institute | 14 | 186 | Ming Engineering | 69 | | | |
| 69 | Crystek | 14 | — | NRI | 8 | | | |

Gernsback Publications, Inc.
 500-B Bi-County Blvd.
 Farmingdale, NY 11735
 1-516-293-3000
 Fax 1-516-293-3115
 President: Larry Steckler
 Vice President: Cathy Steckler

For Advertising ONLY
 1-516-293-3000
 Fax 1-516-293-3115
Larry Steckler
 publisher

Arline Fishman
 advertising director
Shelli Weinman
 advertising associate
Lisa Strasman
 credit manager
Christina Estrada
 advertising assistant

SALES OFFICES

EAST/SOUTHEAST
Stanley Levitan
 Eastern Sales Manager
 Radio-Electronics
 259-23 57th Avenue
 Little Neck, NY 11362
 1-718-428-6037, 1-516-293-3000

MIDWEST/Texas/Arkansas/Okla.
Ralph Bergen
 Midwest Sales Manager
 Radio-Electronics
 540 Frontage Road—Suite 339
 Northfield, IL 60093
 1-312-446-1444
 Fax 1-312-446-8451

PACIFIC COAST/ Mountain States
Marvin Green
 Pacific Sales Manager
 Radio-Electronics
 5430 Van Nuys Blvd. Suite 316
 Van Nuys, CA 91401
 1-818-986-2001
 Fax 1-818-986-2009

Nobody does it better!



Active is committed to giving their customers the best — the best products, from the best known and biggest names in the industry, at the best prices! As an affiliate of Future Electronics, Active has access to a multi-million dollar inventory of quality components and electronic accessories, guaranteeing the best selection in North America. Over 12,000 of the industry's most-demanded parts — semiconductors such as diodes, transistors, digital logic I.C.'s, linear memories, microprocessors as well as power supplies, resistors, switches, test equipment, production tools and so much more!

The largest selection of data books anywhere!

Call, write or visit one of our electronic convenience stores to receive a copy of our 1989 Active catalog — the best selection of electronic accessories and components anywhere. Active gives you the right part, at the right price, delivered right on schedule!

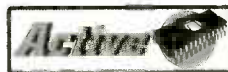

A DIVISION OF FUTURE ELECTRONICS

WESTBOROUGH, MA.
 (617) 366-8899
 MT. LAUREL, N.J.
 (609) 273-2700
 LONG ISLAND, N.Y.
 (516) 471-5400

SEATTLE, WA.
 (206) 881-8191
 DETROIT, MI
 (313)689-8000
 BALTIMORE, MD.
 (301) 536-5400

SANTA CLARA, CA
 (408) 727-4550
 CHICAGO, IL
 (312) 593-6655
 WOBURN, MA.
 (617) 932-4616

TOLL FREE ORDER
800-ACTIVE 4
 (OUTSIDE NEW ENGLAND)
800-ACTIVE 6
 (NEW ENGLAND)

QUICK FIX

Super values on the tools and instruments you need to identify problems, get to them quickly and make repairs easily!

PRECISION HAND-HELD INSTRUMENTS

- Lightweight convenience. Easy to read
- Fast, precise results

B & K Precision Test Bench™

- 41 range voltmeter • Ammeter
- Ohmmeter • Frequency counter
- Capacitance meter
 - Logic probe
 - Transistor & diode tester
 - Extra-large LCD display



Model 388-HD
Reg. \$129.95
Our Price

\$11900

SCOPE Digital Multimeter

- 11 function, 38 ranges including: Logic Level Detector, Audible and Visual Continuity, Capacitance & Conductance measurements.

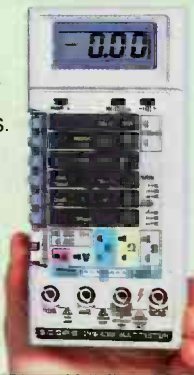

Model DVM-638
Reg. \$87.50
Our Price

\$7995

CA-92 Deluxe Padded Case for DVM meters \$9.95
TL-216 Transistor and Capacitance Test Leads \$9.90

ALL-PURPOSE 92-PC. TOOL CASE

- Complete kit for home, workshop and auto
- Includes 52-pc. socket set with extenders • 2 tool pallets with roomy rear storage compartments • Attractive, rugged carry case.



Model FTK-28
Reg. \$169.95
Our Price

\$12995

DUAL TRACE OSCILLOSCOPES

A.W. SPERRY 20 MHz OSCILLOSCOPE

- Built-in component checker • Z-axis input
- Low power consumption • TV Video sync filter • High-sensitivity X-Y mode • Front panel trace rotator • Includes 2 test probes

Model 620C

\$34995

Our Price

Special Price



HITACHI 35 MHz OSCILLOSCOPE

- 19 calibrated sweeps
- 6" CRT with internal graticule, scale illumination & photographic bezel • Auto focus • X-Y operation
- TV sync separation
- Includes 2 probes (10:1 and 1:1)

Model V-355

\$59800

Our Price



ASK FOR YOUR FREE CATALOG

SCOPE ELECTRONICS

260 Motor Parkway
Hauppauge, New York 11788

TOLL FREE 800-648-2626

(In NY State 800-832-1446 Ext. 242)

TELEPHONE
ORDERS
NOW!



Service & Shipping Charge Schedule Continental U.S.A.

| FOR ORDERS | ADD |
|-----------------|---------|
| \$25-50 | \$4.50 |
| \$51-100 | \$5.50 |
| \$101-200 | \$7.00 |
| \$201-300 | \$8.00 |
| \$301-400 | \$9.00 |
| \$401-500 | \$10.00 |
| \$501-750 | \$12.50 |
| \$751-1000 | \$15.00 |
| \$1,001-1,250 | \$17.50 |
| \$1,251-1,500 | \$20.00 |
| \$1,501-2000 | \$25.00 |
| \$2,001 and Up. | \$30.00 |